

ARNE W. K. TISELIUS

## Electrophoresis and adsorption analysis as aids in investigations of large molecular weight substances and their breakdown products

*Nobel Lecture, December 13, 1948*

The methods, whose development and use I shall attempt to describe in this lecture, have a common characteristic: they are based on certain specific physico-chemical properties of the substances to be studied, namely, their migration in an electric field (*electrophoresis*) or their affinity to the surface of a finely divided solid substance (*adsorption*). These phenomena are specific in the sense that they often display wide variation from substance to substance and therefore are well adapted for the characterization of certain substances which are otherwise difficult to define like proteins and other biocolloids. Electrophoresis and especially adsorption would not, however, have come to play their present roll in chemistry if they had only been utilized for the characterization of different substances. Fundamentally, the significance of these methods up to the present time lies in the opportunities which they offer for making use of these phenomena for a rational *separation* of substances in solution under conditions which are especially favourable to many substances of biochemical significance.

Separation methods for preparative and analytical purposes are, as is well known, of fundamental importance in the chemists' work. It is illuminating that in the Dutch language "Scheikunde" or the Art of Separation, is even today often used as a name for chemistry. Almost daily the biochemist is faced with separation problems in his laboratory. Such is the case when he works with substances belonging to the common organic substances of more or less known structure, and is true to an even greater extent if he is interested in complex substances of large molecular weight, for example: proteins, enzymes, viruses, polysaccharides, and nucleic acids, whose detailed structure is as yet unknown, but which on account of their great significance in fundamental life processes are objects of especially intensive study at present. In these branches of bio-chemistry some of the most important problems are to *isolate* the substances which are responsible for a specific biological or biochemical effect (e.g. certain enzymes) and also to *define*

and *characterize* these substances as accurately as possible. I particularly wish to emphasize that the definition of a chemical entity, which just in this particular field is often extremely difficult, ultimately depends on the separation methods we have at our disposal, or those which are thought to be suitable for use without danger of altering the substance in question. Thus, the problem of separation is of the utmost interest far beyond preparative aspects, and can often supply important information about the existence of biochemically significant complexes, for example between a prosthetic group and a protein in an enzyme. But, in addition to this, fundamental problems in the chemistry of large molecules are to a high degree dependent on the development of suitable and highly specific separation methods. Each attempt to elucidate the chemical structure of these complex substances depends appreciably on the possibility of studying the structure of simpler fragments, which are obtained by breaking down the molecules in some way. The complicated mixtures thus obtained are, however, extremely difficult to separate with the methods now available, particularly if an attempt is made to isolate products resulting from a partial breakdown.

With these words I have tried to give an idea of why we have felt it worth-while to devote a great deal of work to the problem of separation within this field of chemistry. I will principally confine the following discussion to a consideration of the two methods to which the major portion of our work has been devoted.

Unfortunately, time will not allow me to discuss a number of other methods with similar uses, despite the fact that just recently many important advances have been made in this respect.

In principle, two different possibilities may be made use of in order to follow the migration of dissolved substances in an electric field: the *transference* and *moving boundary* methods\*. Both have been known for a long time. As early as 1853, Hittorf studied the transference of the constituent parts of inorganic salts, acids, and bases with an electric current, and in 1886 Oliver Lodge made use of the moving boundary method. Comprehensive studies of the "cataphoresis" or "electrophoresis" - as the phenomenon was called - of proteins and enzymes were undertaken at the beginning of the century by Hardy in England and Michaelis in Germany. My own work on the electrophoresis of proteins commenced in 1925 as a continuation of

\* A third possibility: the direct observation of the migration by means of microscope or ultramicroscope has found important use in colloidal chemistry but is of course limited to cases where the particles are sufficiently large to be observed in this manner.

some experiments by Svedberg, Jette and Scott, in which the moving boundaries of colourless proteins were made visible by fluorescent photography. As this method suffers from several disadvantages I attempted instead to use the method of observation introduced by Svedberg for the observation of ultracentrifugation, namely, photographing in the short-wave ultraviolet light with the use of quartz lenses and with a light filter containing chlorine and bromine. This work was later extended to include several proteins as well as mixtures of proteins. A great advantage of the boundary methods is that the migration of the different components in a mixture can be followed. With the transference method this is not possible unless some convenient method is available for the determination of the amount of each component individually in the limbs of the electrophoresis tube. The experiments which were performed on mixtures and on non-homogeneous proteins up to 1930 with the light-adsorption method clearly showed the usefulness of the electrophoretic method for "electrophoretic analysis". But it also became obvious that a number of technical difficulties would have to be overcome in order that the method should have the resolution capacity required for it to be of value as a general useful tool in biochemistry.

On the basis of experimental and theoretical studies on the numerous sources of error, I undertook (1936-1937) a radical reconstruction of the electrophoresis apparatus. With the aid of some pictures I would now like to discuss the most important technical improvements which distinguish the

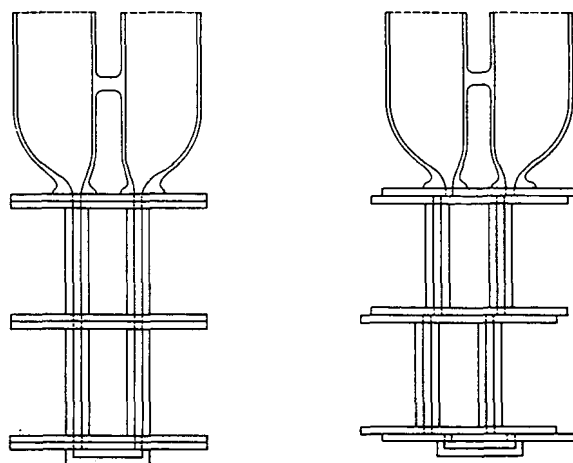

Fig. 1. Electrophoresis U-tube composed of rectangular glass cuvettes.

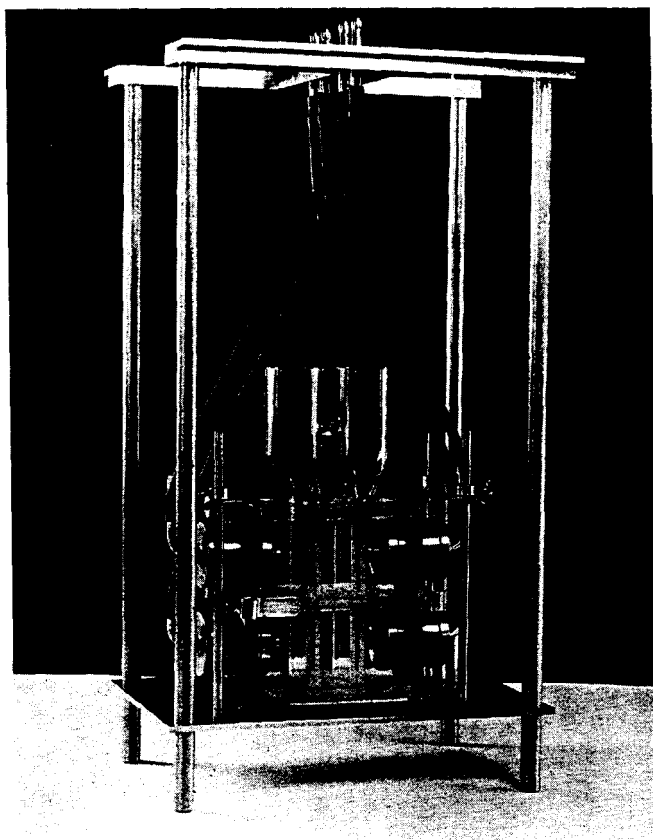

Fig. 2. Electrophoresis U-tube mounted in its stand with pneumatic arrangements for shifting the cells.

new apparatus, and at the same time to mention a number of additional improvements which were later made in Uppsala, principally by Harry Svensson.

The greatest difficulty which is encountered in electrophoretic analysis, when one wishes to increase the resolution capacity by increasing the voltage on the apparatus is due to the fact that the heat of current causes density differences in the solution in the electrophoresis tube. When these reach a value of the same order of magnitude as the density differences across the boundaries the latter are destroyed by convection currents. Even at a somewhat lower load the diffuse parts of the boundaries are distorted and it is impossible to complete the experiment. These distortions can be studied independent of other effects if one uses alternating instead of direct current. There is,

however, a simple way to substantially reduce these distortions. Water, as is well known, has a density maximum at  $+4^{\circ}\text{C}$ . By performing the experiment in a cold thermostat in the neighbourhood of  $+4^{\circ}\text{C}$  the effect caused by the unequal heating is minimized as the density differences for the most part are substantially reduced. Experiments show that by this simple arrangement the load on the apparatus can be increased to an extent corresponding to a potential gradient 8-10 times as high as at room temperature. This is of especial value for experiments with those proteins, which require the presence of considerable amounts of salts in order to stay in solution, as for example, the globulins in blood serum.

Also the form of the electrophoresis tube is of great importance in view of the fact that the convection currents must be reduced to the greatest

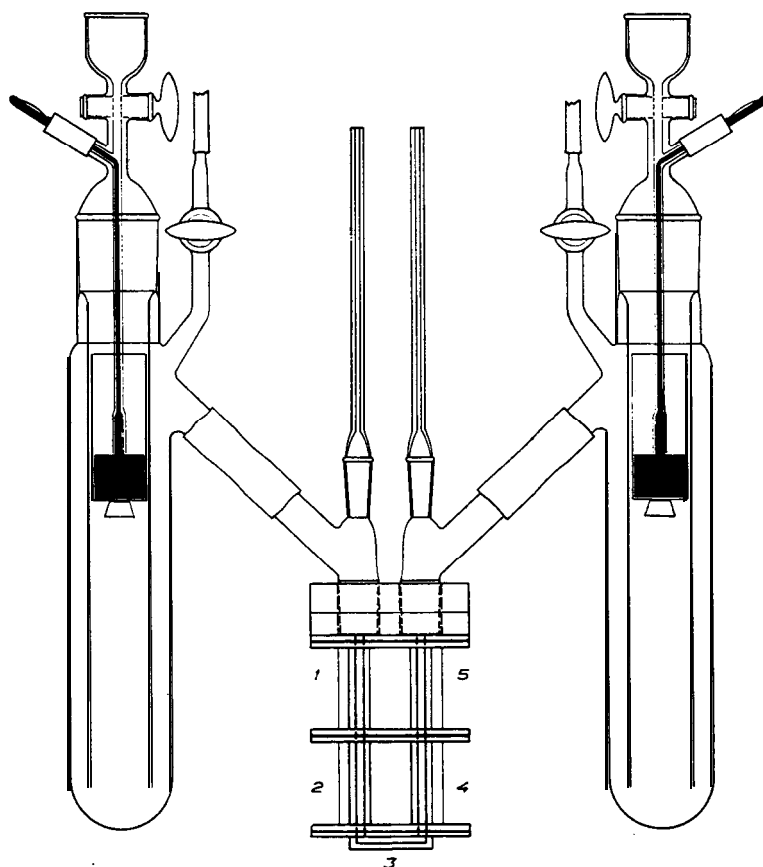

Fig. 3. Electrophoresis U-tube assembled with electrode containers for reversible electrodes.

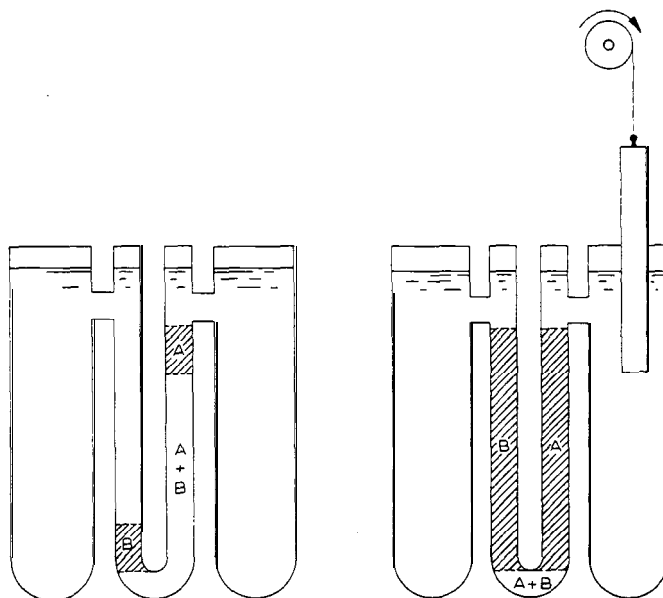

Fig. 4. Compensation arrangement. A slow depression of the plunger into one electrode vessel (*to the right in the figure*), by clockworks, causes a slow and accurately known shift of the solution in the U-tube in a direction opposed to that of the migration. By this means the separation of two substances A and B can be carried out much farther than without compensation (*compare with picture to the left*).

possible extent. Instead of a cylindrical tube, a tube was introduced with a rectangular cross section. The final model, which is shown in Figs. 1-3 was designed in order to facilitate the application of optical methods of observation and in order to provide a convenient way of forming boundaries at the beginning of the experiment as well as to facilitate the removal of samples at its termination. The tube is composed of sections made of acid-fast cemented plane-glass plates. These sections lie against one another with horizontal ground glass plates between, and can be moved in relation to each other in the horizontal direction with a pneumatic arrangement (Fig. 2).

Using this construction it is possible to perform the electrophoretic analysis during one experiment with both boundary and transference methods. The latter method's applicability in enzyme chemistry had already been demonstrated by Michaelis, but an electrophoretic analysis of enzymes was first performed by Hugo Theorell in the middle thirties with a modified transference apparatus of his own construction. This work which among other things led to the clarification of the nature of Warburg's yellow en-

zyme, contributed in a large extent to making the electrophoretic method known.

Additional technical details of significance in the new construction have been the electrode vessels of ample size with their reversible Ag-AgCl electrodes together with the so-called compensation or the counter-current device. The latter has made it possible to make maximal use of the electrophoresis tube's capacity even in the case when fast components would migrate out of the tube before an appreciable separation has taken place.\* The improved type used most frequently nowadays is of somewhat different construction which makes use of an injection syringe operated by an adjustable clockwork or a synchronous motor.

The optical method used for the observation of the boundaries is based on the localization and quantitative determination of refractive index gradients due to the boundaries in the electrophoresis tube.

Such a method is considerably more sensitive than those based upon light absorption when the detailed concentration distribution in the electrophoresis tube is to be studied. Before the new apparatus was constructed, I had tried observation methods based upon the curvature of a light beam in a concentration gradient, and for the first form of the new method, the simplest of these was chosen, namely the Toepler "schlieren" method. Some typical "schlieren" photographs of electrophoresis of a uniform protein and of mixtures are shown in Fig. 5. The method is well suited for the localiza-

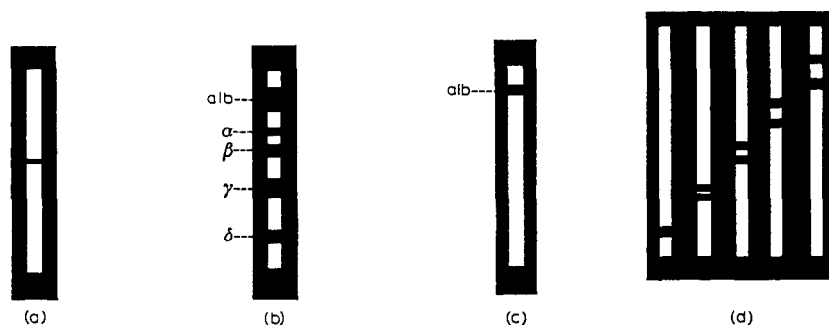

Fig. 5. Schlieren photographs of an electrophoresis cell showing migrating boundaries. (a) Egg albumin; (b) horse serum; (c) serum albumin, isolated from horse serum by electrophoresis; (d) a mixture of egg albumins from guinea hen and duck (according to Landsteiner and Van der Scheer).

\* The compensator's mode of operation is shown schematically in Fig. 4 and should speak for itself.

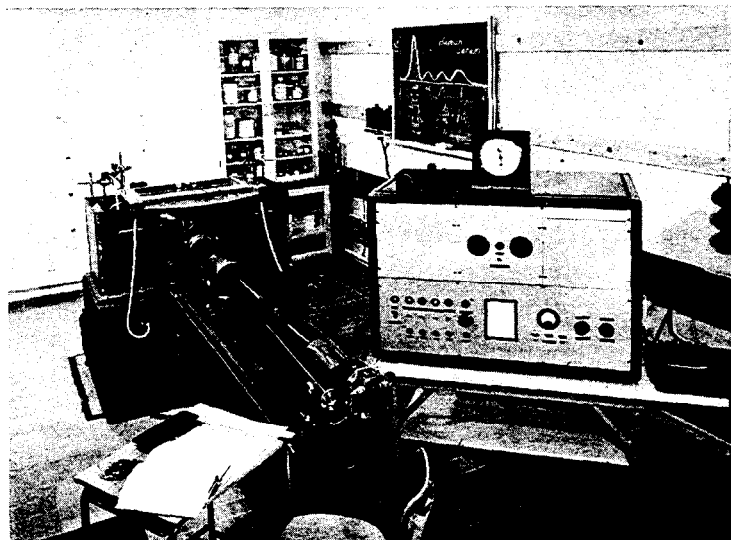

Fig. 6. A complete electrophoresis apparatus with schlieren optics according to Svensson.

tion of the boundaries, but must be developed further if one wants a complete record of the concentration distribution in one and the same exposure. This can be arranged in several different ways: a mechanical coupling between the plate-holder and the schlieren diagram (Longworth), application of a schlieren slit and a cylindrical lens (Philpot, Svensson). Fig. 6 shows a complete arrangement for electrophoresis with optical equipment according to Svensson.

I will show some figures which illustrate the type of electrophoresis diagram obtained by these observation methods, and which at the same time may serve as examples of the use of electrophoretic analysis in the study of proteins. Fig. 7 shows some electrophoresis diagrams from experiments with

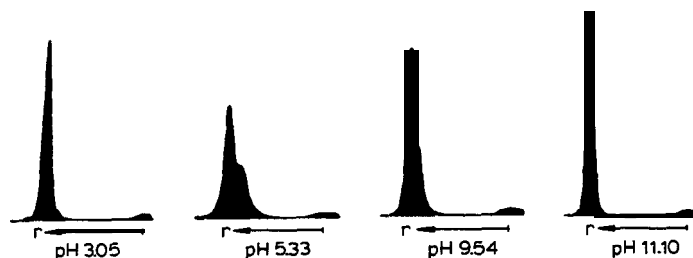

Fig. 7. An electrophoresis diagram taken by Longworth's scanning method, showing the inhomogeneity of egg albumin at certain pH's (according to Longworth).



egg albumin, which in general is considered to be a relatively well-defined protein. At certain pH values it shows complex diagram, as seen in the figure, indicating inhomogeneity. In a very large number of investigations of proteins, enzymes, antibodies, viruses, etc. the method has been used as a criterion for purity in this manner, and has often shown that the substances are more complex than was originally supposed. On the other hand one must not, from an apparently uniform diagram containing a single peak, draw the conclusion that the material is homogeneous. Electrophoresis is only one of the many criteria which must be used to obtain decisive information in this respect.

As an aid and guide in preparative work, electrophoresis is often of great value. Step by step it is possible to follow the preparation and see how one component partially or completely separates from another just in the manner spectral analysis is made use of in inorganic chemistry.

The method has been of importance in the problem of fractionating blood serum. Among the first results obtained by the new apparatus was the fact, that in electrophoresis, serum gives a number of relatively distinct components, namely: albumin,  $\alpha$ ,  $\beta$ , and  $\gamma$  globulin (see diagram Fig. 5 b and Fig. 8). It was subsequently found that further subdivision of some of these components could be made. During the course of extensive investigations on serum fractionation, which were performed in the U.S.A. during the recent war, and particularly by Edwin Cohn and his co-workers, electrophoresis and ultracentrifugation were used as controls during the fractionation procedure. Fig. 9 shows a number of electrophoresis diagrams obtained from such a fractionation.

Some other applications in protein chemistry ought to be mentioned. Horsfall and I have shown, through electrophoretic analyses, that the reversible dissociation of hemocyanins is conditioned by factors possessing pronounced biochemical specificity, so that closely related species can form mixed molecules by the reassociation of the dissociation products, which is not possible with hemocyanins of more distant species.

The electrophoresis diagram also gives the migration velocities of the different components at the particular pH and salt medium in which the experiment is being conducted. It is also possible to obtain a quantitative estimation of the relative amounts of components present, at least under certain conditions. A knowledge of these conditions is a necessary prerequisite for the successful use of electrophoretic analysis even when apparatus construction is quite perfect. The ideal case for electrophoretic migration is a con-

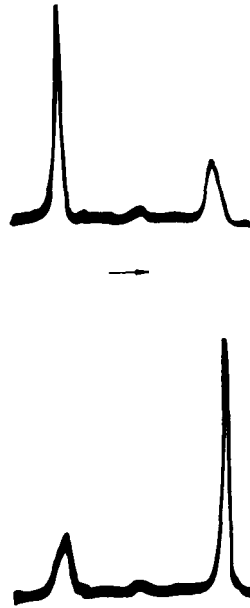

Fig. 8. Electrophoresis diagram by Svensson's optical method of a pathological serum from a patient with an abnormally high percentage of  $\gamma$ -globulin.

stant potential gradient and with constant conductivity throughout the entire electrophoresis tube. These conditions are however never completely fulfilled, as the migrating substances themselves have a certain conductivity, and therefore eventual differences in the potential gradient can be further accentuated through the accumulation or spreading out of the buffer ions migrating in the inhomogeneous field. The theory for these effects and the manner in which they influence the boundaries' migration has been worked out by Kohlrausch, Weber, and Van Laue, and further developed with special regard to electrophoretic analysis by Svensson, Dole, and several others. One would expect these phenomena, which we have called boundary anomalies, to be present, when the substances under investigation are responsible for an important part of the total electrical transport through the electrophoresis tube. From this it follows that experiments should be performed in media of high conductivity and that even then only substances of comparatively low specific conductivity are suitable for electrophoresis, for example, proteins and many other high molecular weight substances. A lack of symmetry in the observations of the two limbs of the electrophoresis

tube with regard to mobility, the number of boundaries, or the relative amounts observed for the different components is a sign that such anomalies interfere. In most electrophoretic measurements these anomalies are not sufficiently eliminated. However, it is possible with the aid of the above-mentioned theoretical analysis to predict to a certain extent the most favourable conditions for eliminating the sources of error. Moreover, it is possible from two or more experiments, by utilizing different salt or protein concentrations to extrapolate to the value which should be obtained at zero protein concentration or at a high salt content.

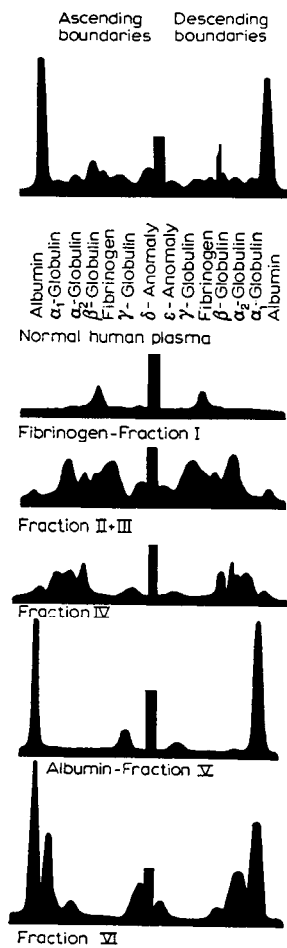

Fig. 9. Electrophoresis diagrams from different stages in the fractionation of human plasma (according to Cohn).

It is apparent from the above discussion that further improvements in the apparatus and method must above all be aimed at the possibility of performing the experiment with as low concentrations of the substances studied as is possible. This implies further increasing the sensitivity of the optical method, a problem which should be quite possible to solve. At present work in this direction is in progress at Uppsala as well as elsewhere. By such improvements one ought to gain not only an increased accuracy in electrophoretic analysis in general, but also an extension of the applicability of the method to substances of lower molecular weight, for example peptides.

The advantages of the electrophoretic method are above all its gentleness and its marked specificity. During the entire course of a separation the substance remains in solution of approximately constant composition, thereby eliminating the risk of denaturation and other irreversible changes which so easily influence processes dependent on precipitation. This advantage is also characteristic of separation by ultracentrifugation. Frequently proteins, enzymes, and other substances which have been purified by precipitation or by repeated recrystallization are nevertheless found by electrophoretic analysis to be inhomogeneous. This is probably due to the fact that substances of such a nature show a great tendency to carry foreign substances with them on precipitation. The components are more likely to be free from one another in solution, and as the electrophoretic separation depends only on differences in mobilities it is of little importance if the impurities are present only in very small quantities. The separation proceeds just about as readily - in contrast to what is usually the case in most other separation methods.

The method's great convenience has, however, certain limitations which should be indicated. In electrophoretic migration only those molecules or particles which are free from one another in the solution are separated. If complex groups or associations of some type exist, a separation can only be expected to the extent in which these complexes are dissociated. A component which under certain conditions in electrophoresis is observed to be homogeneous can also very well, under different conditions (with less gentle treatment or merely by a change of pH) show itself to be of complex nature. However, electrophoretic (as ultracentrifugal) observations are of considerable interest also in such a case from an entirely different point of view. The gentleness of the method should often make it possible to draw the conclusion that such demonstrated complexes may even be present in the original material, that is to say, when we deal with proteins, in the living organism itself. It is not necessary to be a vitalist in order to express the

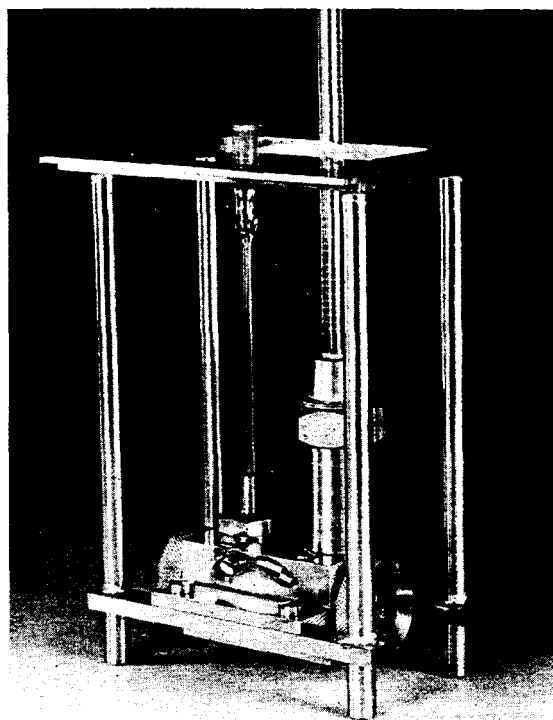

Fig. 10. Micro-interferometer for adsorption analysis. The capillaries of the interferometer lie horizontally in a brass block. The solution is allowed to run from a burette through a filter containing the adsorbent (to the right). The outlet tube is seen to the left.

opinion, that what from a chemist's viewpoint may be taken as a strongly retained impurity (for example the lipid in a lipo-protein complex), from a biological viewpoint perhaps may possess a vital function. Throughout the course of biochemistry - quite naturally - principal interest has been directed to the chemical entities that have been isolated from biological materials, but there is little doubt that in the future much closer attention must be paid also to the existence of specific complexes in the living organism. It is the chain of events with linked reactions which is the key note of life's processes and this interrelationship or linkage can perhaps best be conceived as the result of an association of substances with different specific functions.

The problems of separation and characterization of high molecular substances, which I spoke of at the beginning of this lecture as a leading theme for our work, cannot be solved by only one method - in this field one must

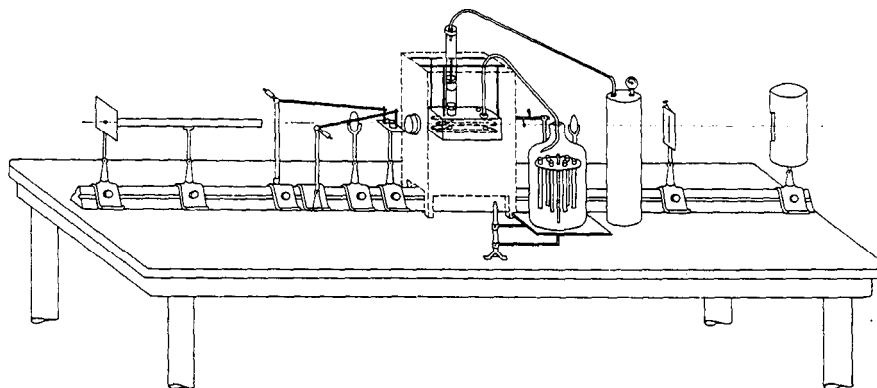

Fig. 11. Schematic diagram of an apparatus for interferometric adsorption analysis.

be especially prepared to apply different methods of procedure before drawing definite conclusions. The multitude of substances which must be dealt with, even from a single kind of original material, sets a very high requirement for the specificity of the methods. Electrophoretic specificity is often pronounced - I may refer to the picture of the separation of different egg albumins (Fig. 5d). But in other cases it is quite insufficient. As an example I may point to the fact that the method does not allow for differentiation between normal and immune  $\gamma$  globulin in immune sera. It is of course natural that a method which only makes use of the differences in electrochemical qualities cannot fulfil the requirements in all conceivable cases.

In 1940 I began some experiments in order to make use of the chromatographic analysis in the separation of proteins and of their breakdown products. This was considered worth a trial on account of the remarkable specificity which this separation method shows for different organic substances, which had become evident in the course of numerous investigations during the years following the original work of Tsvett in 1906. The particular difficulties which had been encountered (such as boundary anomalies) in the electrophoresis of peptides and similar breakdown products of proteins made it also desirable to find a method especially adaptable for the separation of these substances.

The method which was subsequently worked out was intended to attain a high degree of precision for the observation of even very small separations and was from the beginning developed for work on colourless substances, for which the ordinary method of observing the migration of the zones directly on the column cannot be used.

In principle the method involves the continuous measurement of a solution's concentration by some convenient method - after the solution has passed through a column of adsorbent. Usually the measurements are made with a micro-interferometer. The adsorbent is packed into cylindrical cells made of gold-plated brass or of perspex which are then coupled to the interferometer (Fig. 10). After emerging from the interferometer, the solution runs out into graduated test tubes whose position can be changed as the different fractions emerge. Fig. 11 shows the arrangement, with the interferometer in a thermostat; the optical parts, together with a compressed-air tank, used to provide the necessary pressure for the filtration through the column. In working out the method Dr. Claesson has made very valuable contributions, particularly by his construction of the micro-interferometric apparatus just described.

The concentration as expressed in terms of the refractive index is plotted

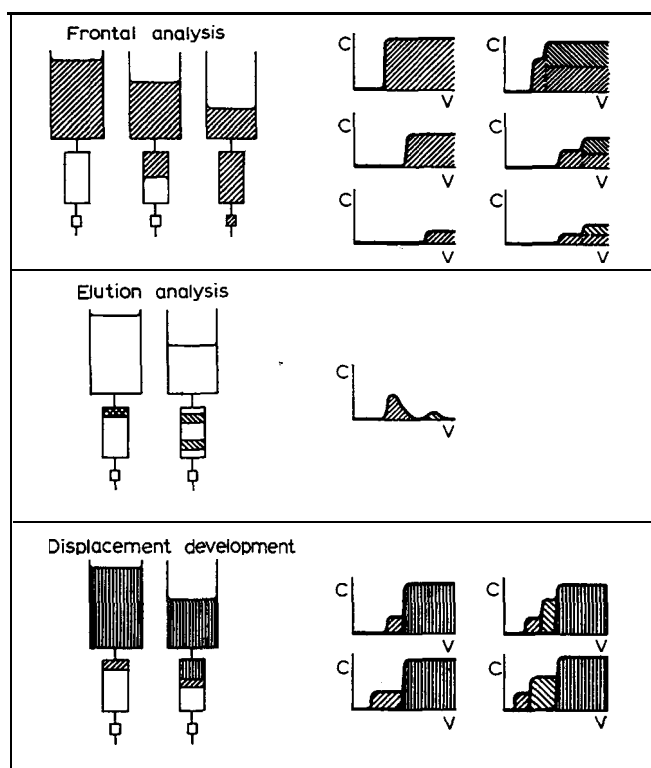

Fig. 12. Different types of adsorption analysis.

in a diagram as a function of the volume which has passed through the filter. Schematic diagrams of this type are shown in Fig. 12. The three curves represent the methods, somewhat different in principle, which are used for this type of adsorption analysis. In the first case the solution to be investigated is allowed to run through the column uninterruptedly and the curve furnishes the form of the adsorption front with a differential separation of the same type as that accomplished by electrophoresis. We have called this frontal analysis. Each new step represents a component, and the height of the step is proportional to the component's concentration in the original solution when the different components are adsorbed independently of one another. However, this is the case only with very dilute solutions or in cases of very weak adsorption. Claesson, who has devoted himself especially to this type of adsorption analysis, has shown, that the law which governs adsorption in homologous series (Traube's rule) makes it possible to apply a relatively simple correction for the effect of mutual displacement. He has used this method, among others, for the analysis of mixtures of the higher fatty acids. The second method, *elution*, only requires a smaller quantity of the material, which is adsorbed on the top of the column after which a pure solvent is pressed through the column. The components emerge as completely separated peaks in the diagram. We have not used this method a great deal because, at least in cases of stronger adsorption, the peaks are too much spread out and the concentration becomes too low for our interferometer. The third curve shows the so-called *displacement analysis*. Here also a small quantity is first pressed into the column, after which a solution of a suitable displacing agent is pressed through - that is to say, a substance which is adsorbed more strongly than any of the components present in the test solution. It may easily be shown that when the displacing agent's front passes down through the adsorption column, there develops before the front a system of closely adjoining zones, each one containing a pure component. The concentration of each zone depends only on the coefficient of adsorption, while the zonal width is proportional to the quantity of the component in question. Thus a complete separation is effected without the admixture of an elution agent and the resultant diagram makes it possible to identify the components and estimate the relative quantities of each.

In principle it is of course possible to use any convenient method - physical or chemical - in order to follow the processes of adsorption in this manner. It is also possible, by means of a suitable automatic sampler to collect



successive fractions of the solution emerging from the column in order to make subsequent determinations of the percentage of dissolved substance in each fraction. The latter method or procedure has been used particularly by Moore and Stein at the Rockefeller Institute in New York, and has been found most convenient for experiments with low concentrations of material or for experiments which take a long time to run - it is certainly not convenient to make continual interferometric observations over a period of days. On the other hand continuous observation is necessary when frontal analyses are being performed or where there are many components with only slightly different adsorption.

Just as chromatographic methods in general, these methods are useful for the analysis of substances of the most varied sort. We have performed a very large number of model experiments on amino acids, peptides, sugars, fatty acids and fats, etc. As an illustration I will show some pictures which demonstrate some applications of the procedure. Fig. 13 shows the results of a frontal analysis conducted on a mixture of homologous fatty acids (Claesson). Fig. 14 shows a displacement analysis with carbohydrates, and Fig. 15 a displacement analysis of peptides. (For further details see the figure captions.)

The principal interest in adsorption analysis of the type described lies however in the possibilities for its use on large or intermediate-sized molecules - if the latter phrase is understood to mean the larger breakdown products of high molecular substances. For many of these substances, amino acids, lower peptides and different sugars, simple and effective chromatographic

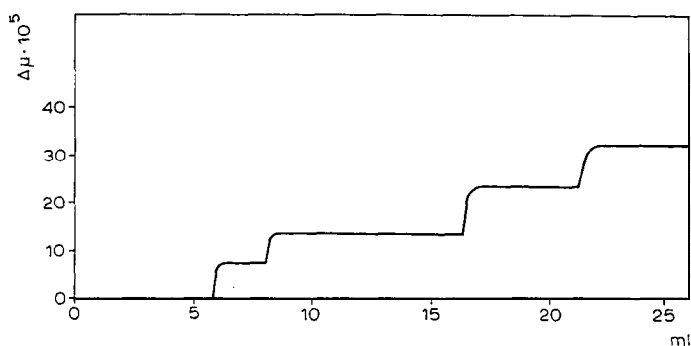

Fig. 13. Frontal analysis of a mixture of four fatty acids, with 8, 10, 14, and 16 carbon atoms in ethyl alcohol, with active carbon as an adsorbent. *Abscissa*: volume. *Ordinate*: refractive-index increment (Claesson).

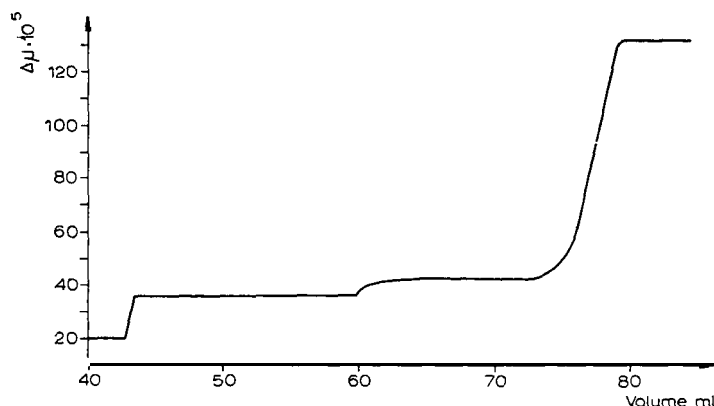

Fig. 14. Displacement analysis on carbon of a mixture of 25 mg sucrose and 25 mg maltose. (Displacing agent: 0.5% phenol.)

methods are now available, particularly the excellent methods for partition chromatography worked out by Martin and Synge. Thus there is hardly any reason for using the more complicated methods described above on such substances except in special cases. Of course the larger the molecules one has to deal with, the more difficult it becomes in general to find a suitable pair of solvents for use in partition experiments. In such cases it may generally be easier to find suitable adsorbents and to make use of these in frontal or displacement analyses in the manner I have just described.

These methods are still in the process of development, and I will only mention a few examples of their use in the work now in progress. Fig. 16 shows a frontal analysis of insulin which was partially broken down by oxidation, and the solution may be interpreted as containing at least four components. Fig. 17 has been taken from a recently published work by Claesson on the adsorption analysis of high polymers and shows the composition (weight frequency) as a function of the retention volume for three different polymethylmetacrylates, as obtained by frontal analysis.

For a quantitative estimation of these diagrams it is of the utmost importance that as low a concentration as possible can be used. It is accordingly of great interest that Claesson has recently been successful in constructing a new adsorption analysis interferometer with approximately five times the sensitivity of the previous model. The large separation of high polymers of the polymetacrylate and nitrocellulose types which Claesson has succeeded in accomplishing indicates that adsorption analysis in this field will come to assume great importance.

For proteins and similar substances the immediate problem is to find suitable adsorbents. Above all, a relatively quick and reversible adsorption process is required for chromatographic analyses, and for this reason many adsorbents commonly used in biochemistry cannot be used for these substances. The advantages in the use of the chromatographic procedure - in the form just described or with some similar method - are however so great that it appears worth-while to search for such adsorbents. The advantage of using an adsorption column in comparison to the simple one-stage operation ("batch process") is almost comparable to the benefits accrued from the use of a distillation column instead of a simple evaporation procedure for the fractionation of fluid mixtures. Just recently we have studied an adsorption phenomenon previously hardly known, which we have called *salting out adsorption*, which possibly may fulfil the recently mentioned requirement

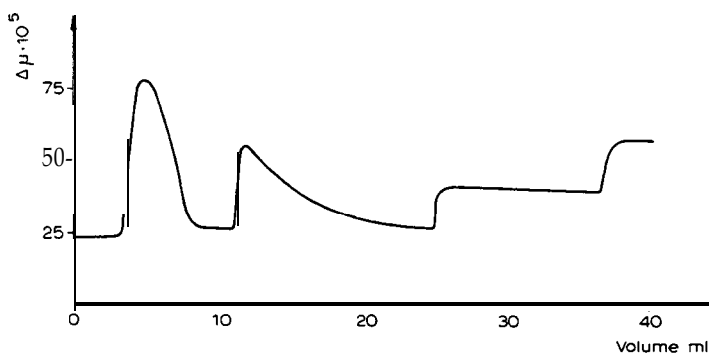

Fig. 15. Displacement analysis of valine, leucine, methionine. (Displacing agent: 0.5% ethylacetate.)

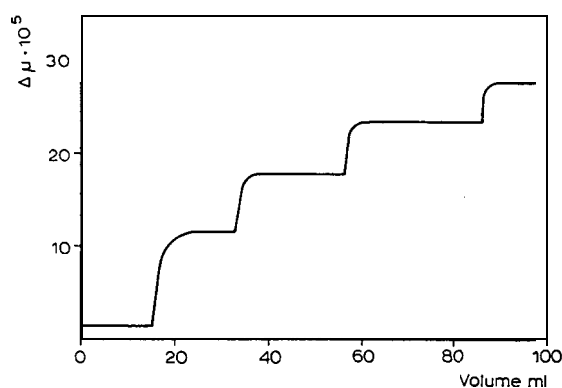

Fig. 16. Frontal analysis of partially broken-down insulin (according to Sanger).

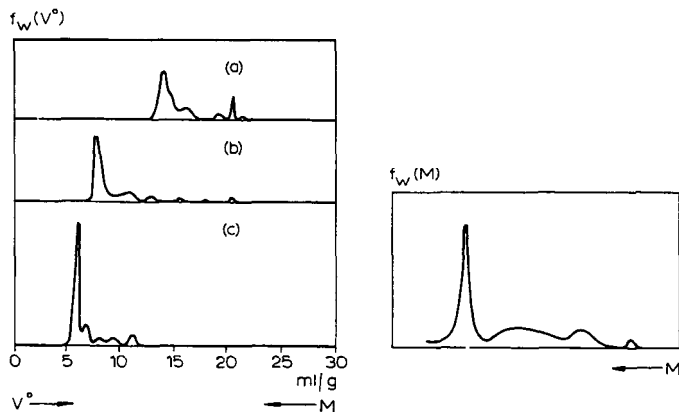

Fig. 17. Weight frequency curves of three different synthetic polymethylmetacrylates, obtained from frontal analysis curves (average molecular weight about 200,000). The curves give the frequency as a function of the adsorption (the retention volume). To the right is shown in comparison a curve for the preparation number 2, obtained from a number of ultracentrifugations on material which was fractionated by precipitation (Claesson).

for many proteins and similar substances. The adsorbent used in the column is a finely divided material which in water or weak salt solutions does not adsorb proteins or does so only very slightly. It has long been known that proteins can be "salted out" from solutions of, for example, ammonium sulphate in high concentrations. As this must depend on an increase of the thermodynamic activity of the protein molecules in the solution due to the salt, it must be expected that the adsorption will increase provided that the adsorbent is not influenced. In actual practice it is found that both with several proteins and a number of dye-stuffs and other salt-precipitable substances a strong adsorptive effect can be developed in this manner on various comparatively indifferent adsorbents, such as filter paper, starch, silica gel, etc., with salt concentrations essentially lower than is necessary for precipitation. The adsorption seems to be reversible and elution is accomplished by washing with water or with a weaker salt solution. Also by this means, the column is restored to its original condition and may be used again. An example of a separation by means of salting out adsorption on filter paper is shown in Fig. 18.

Salting out adsorption is shown by several proteins and even by some of their larger breakdown products. Also some viruses seem to show a pro-

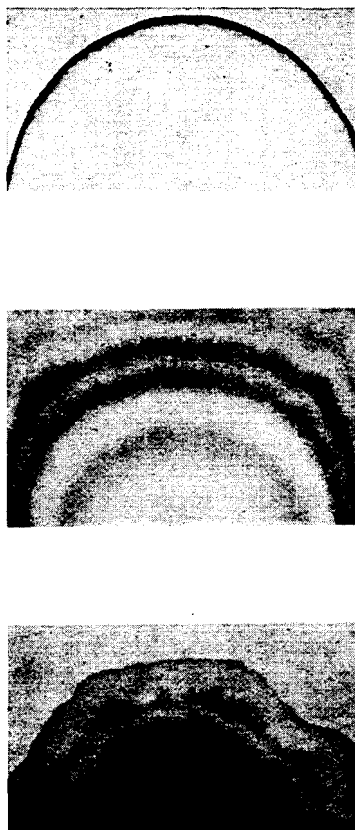

Fig. 18. The separation of dyes by salting out adsorption on filter paper. (*Top*): A mixture of naphthol green and fuchsin in water gives no separation. (*Middle and bottom pictures*): The same experiment in 1 molar and 2 molar ammonium sulphate solution gives a marked separation of the fuchsin (which is shown to contain three components) and naphthol green.

nounced effect. Up to the present, only intestinal virus from mice and from the foot-and-mouth disease have been tested, both with promising results.

It is perhaps too early yet to predict what practical value this method may attain - in conjunction with the recently described methods of observation. It is certain, however, that the need for specific and gentle methods of separation in the high molecular field is great, especially with respect to the enormous multitude of substances occurring in nature which are similar chemically but dissimilar with respect to function and activity.