

THE DISCOVERY OF THE J PARTICLE:

A personal recollection

Nobel Lecture, 11 December, 1976

by

SAMUEL C. C. TING

Massachusetts Institute of Technology, Cambridge, Massachusetts, USA

and

CERN, European Organization for Nuclear Research, Geneva, Switzerland

1. PHOTONS AND HEAVY PHOTONS

The study of the interaction of light with matter is one of the earliest known subjects in physics. An example of this can be found in the *Mo Tsu* [1] (the book of Master MO, Chou Dynasty, China, 4th century B.C.). In the 20th century, many fundamentally important discoveries in physics were made in connection with the study of light rays. The first Nobel Prize in Physics was awarded to W. C. Röntgen in 1901 for his discovery of X-rays.

In modern times, since the work of Dirac, we realized the possibility of the creation of electron-positron pairs by energetic light quanta. The work of W. E. Lamb and R. C. Retherford provided a critical step in the understanding of interactions between photons and electrons. The elegant formulation of quantum electrodynamics by S. Tomonaga, J. Schwinger and R. Feynman, F. J. Dyson, V. F. Weisskopf and others has led to a procedure for calculating observable effects of the proper electromagnetic field of an electron.

In the last decade, with the construction of giant electron accelerators, with the development of sophisticated detectors for distinguishing electrons from other particles, and finally with the building of electron-positron colliding beam storage rings, much has been learnt about the nature of very high energy light quanta in their interactions with elementary particles. The study of interactions between light and light-like particles (the so-called vector mesons, or heavy photons) eventually led to the discovery of a new family of elementary particles—the first of which is the J particle.

My first knowledge of the concept of light quanta and the role they play in atomic physics came from the classical book “The Atomic Spectra” by Herzberg [2], which I picked up in the summer of 1957 when I was working in New York as a summer student. Just before my graduation from college, I received as a Christmas gift from my father the English translation of the book “Quantum Electrodynamics” by Akhiezer and Berestetskii [2]. During my school years at Michigan I managed to go through this book in some detail and worked out some of the formulas in the book myself. Then, during my years as a junior faculty member at Columbia University, I read with great interest a paper by Drell [2], who pointed out the implications of various tests of quantum electrodynamics at short distances using high-energy electron accelerators. I did a theoretical calculation with Brodsky [3] on how to isolate a certain class of Feynman graphs from the muon production of three muons.

There are basically two ways of testing the theory of interactions between photons, electrons, and muons. The low-energy method, like the Lamb shift or $(g-2)$ experiment, tests the theory to high accuracy at a long distance (or small momentum transfer). For example, the most recent experiment done at CERN by Picasso and collaborators [4] to measure the g -factor anomaly of the muon with a muon storage ring, obtained the result:

$$(g-2)/2 = 0.001165922 + 0.000000009 \text{ (an accuracy of 10 parts per million).}$$

This result can be compared with calculations of quantum electrodynamics, including corrections from strong and weak interactions. The theoretical number is

$$(g-2)/2 = 0.001165921 \pm 0.000000010,$$

a most fantastic achievement of both experiment and theory.

The other way of testing quantum electrodynamics involves the study of reactions at large momentum transfers. Using the uncertainty principle $\Delta x \Delta p \approx h$, this type of experiment, though much less accurate, probes the validity of QED to a large momentum transfer or to a small distance. One such experiment, the process of e^+e^- production by multi-GeV photons in the Coulomb field of the nucleus, has both electromagnetic and strong interaction contributions to the e^+e^- yield. By properly choosing the kinematical conditions we can isolate the contributions from quantum electrodynamics alone and reduce the yield from strong interactions to a few percent level. The momentum transfer to the electron propagator is about 1 GeV; it is related to the effective mass of the e^+e^- pair. The yield of QED pairs is of the order α^3 ($\alpha = 1/137$). Because the yield is third order in α , to obtain a reasonable amount of events the experiment must be able to handle a high intensity of incident flux. A large acceptance detector is necessary not only to collect the events but also to average the steep angular dependence of the yields.

The effective mass of a pair of particles emitted from the same point is obtained by measuring the momentum of each of the particles p_1 and p_2 , and the angles θ_1 and θ_2 between their paths and the incident beam direction, and by identifying the two particles simultaneously so that their masses m_1 and m_2 can be determined. The effective mass m of the pair is defined by:

$$m^2 = m_1^2 + m_2^2 + 2[E_1 E_2 - p_1 p_2 \cos(\theta_1 + \theta_2)],$$

where \mathbf{E}_i = total energy of the particle.

A pair spectrometer has two arms, which measure simultaneously the momenta p_1 and p_2 of the particles and the angles θ_1 and θ_2 . Owing to the immense size of the equipment required, the physical position of each arm is often preselected. This restricts θ_1 and θ_2 to a relatively narrow band of possible values. Different effective masses may be explored by varying the accepted momentum of the particles p_1 and p_2 .

When the two particles are uncorrelated, the distribution of m is normally a smooth function. A 'narrow' resonance will exhibit a sharp peak above this smooth distribution, while a 'wide' resonance will produce a broader bump.

The identification of particles from the spectrometer is done by

- i) measuring the charge and momentum of the particle from its trajectory in a magnetic field;
- ii) determining for a given trajectory, or a given momentum, the mass of the particle by measuring its velocity and using the relation $p = m \cdot v$.

The measurement of velocity can be done with Čerenkov counters using the Čerenkov effect. For electrons, their additional property of having only electromagnetic interactions can be used. When an electron enters a dense piece of lead, it loses all its energy by a cascading process which releases photons. The amount of light emitted from a lead-lucite sandwich shower counter (or a lead-glass counter) is thus proportional to the energy of the electron.

In October, 1965, I was invited by W. Jentschke, then Director of the Deutsches-Elektronen Synchrotron (DESY) in Hamburg, Germany, to perform my first experiment on e^+e^- production [5]. The detector we used is shown in Figs. 1a and 1b. It has the following properties that are essential to this type of experiment: i) it can USC an incident photon flux of $\sim 10^{11}/s$, with a duty cycle of 2 - 3 % ; ii) the acceptance is very large and is not limited by edges of the magnets or by shielding, being defined by scintillation counters alone; iii) all counters are located such that their surfaces are not directly exposed to the target; iv) to reject the hadron pairs, the Čerenkov counters are separated by magnets so that knock-on electrons from the pions interacting with gas radiators in the first pair of counters LC, RC are swept away by the magnet MA and do not enter the second pair of counters HL, HR. The low-energy knock-on electrons from HL, HR are rejected by shower counters.

The large number of Čerenkov counters and shower counters enables us to perform redundant checks on hadron rejection. Since each Čerenkov counter is 100% efficient on electrons and not efficient on hadrons, the observation that:

the yield of e^+e^- from 3 Čerenkov counters =

the yield of e^+e^- from 4 Čerenkov counters,

ensures that we are measuring pure e^+e^- pairs. The combined rejection is $\gg 10^8$.

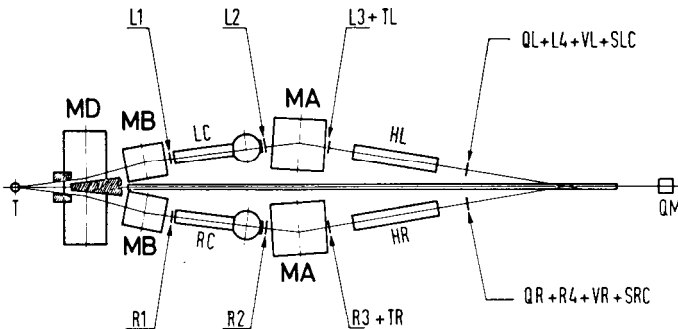

Fig. 1a. Plan view of the spectrometer. MD, MA, RIB are dipole magnets; L1, L4, and R1, R4, are triggering counters; LC, RC, and HL, HR are large-aperture threshold Čerenkov counters; SLC, SRC are shower counters; and TL, QL, VL, and TR, QR, VR are hodoscops. QM is a quantameter.

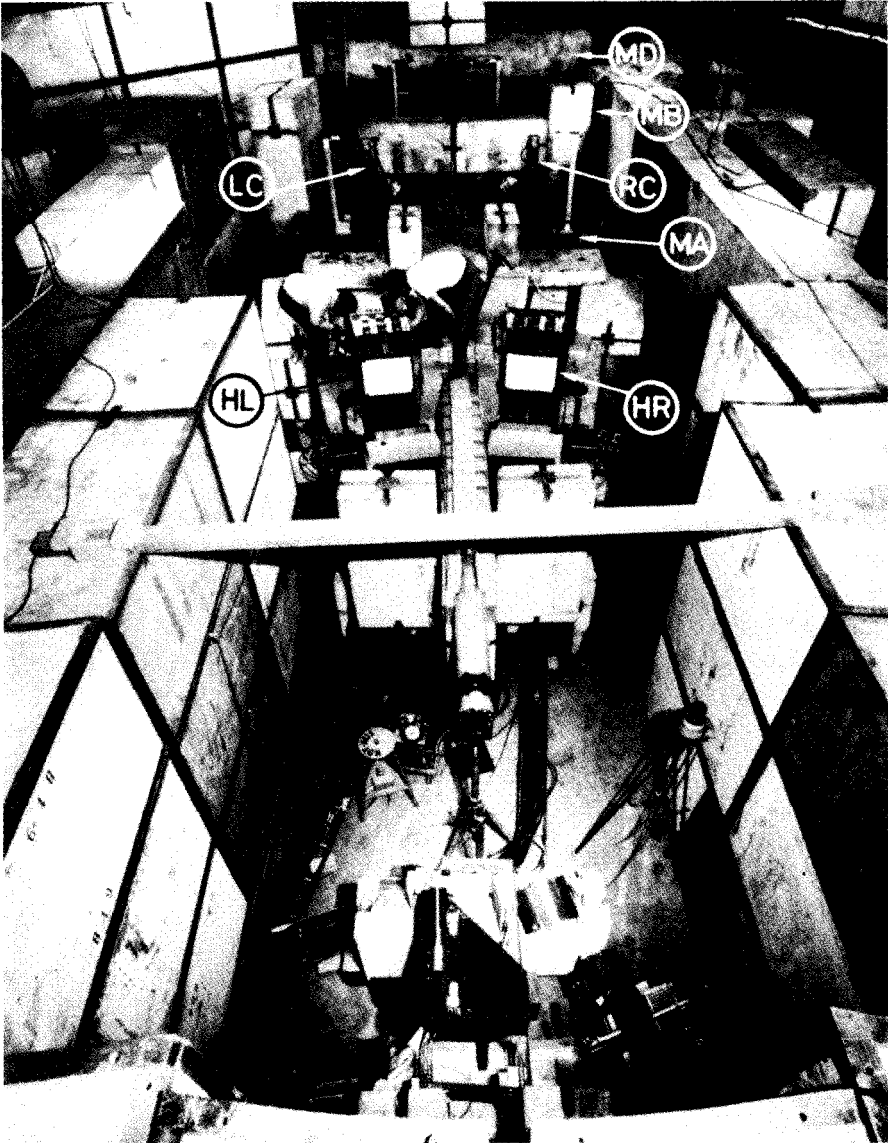

Fig. 1b. Over-all view of my first experiment at DESY. The position of LC, RC, HL, HR, MA, and MD are all marked. The physicist on the left is Dr. A. J. S. Smith; on the right is Dr. C. L. Jordan.

After we had finished this experiment, which showed that quantum electrodynamics correctly describes the pair production process to a distance of $\approx 10^{-14}$ cm, we tuned the spectrometer magnets so that the maximum pair mass acceptance is centred near $m \approx 750$ MeV. We observed a large increase in the e^+e^- yield and an apparent violation of QED. This deviation is caused by an enhancement of the strong interaction contribution to the e^+e^- yield where the incident photon produces a massive photon-like particle, the ρ meson, which decays into e^+e^- [6-8] with a decay probability of order α^2 .

In order to show that this is indeed the case, we made another measurement at a larger e^+e^- opening angle and observed an even larger deviation from QED. This is to be expected since the QED process decreases faster than the strong interaction process when we increase the opening angle of the e^+e^- pair.

The observation of $\rho \rightarrow e^+e^-$ decay started a series of experiments by my group on this subject [9-12]. Basically the heavy photons ρ, ω, φ , are resonance states of $\pi^+\pi^-(\rho), \pi^+\pi^-\pi^0(\omega), K^+K^-$ or $\pi^+\pi^-\pi^0(\varphi)$ with a rather short lifetime of typically $\approx 10^{23} - 10^{24}$ s. The widths of these particles are $\Gamma_\rho \approx \approx 100$ MeV, $\Gamma_\omega \sim 10$ MeV, and $\Gamma_\varphi \approx 5$ MeV. They are unique in that they all have quantum numbers J (spin) = 1, C (charge conjugation) = -1, P (parity) = -1. Thus they are exactly like an ordinary light-ray except for their heavy mass. The mass of ρ is $m_\rho \simeq 760$ MeV, and $m_\omega \simeq 783$ MeV; $m_\varphi \approx 1019.5$ MeV.

The production of heavy photons by photons on nucleon and nuclear targets shows that it is a diffraction process very much like the classical scattering of light from a black disk. The experiments on photoproduction of heavy photons and observation of their e^+e^- decay measure the coupling strength between each heavy photon and the photon. The interference between the e^+e^- final state from heavy photon decays and e^+e^- from QED measures the production amplitude of the heavy photon. The interference between these amplitudes can be viewed classically as a simple two-slit experiment, where in front of one of the slits we placed a thin piece of glass (corresponding to $\gamma \rightarrow \rho \rightarrow \gamma \rightarrow e^+e^-$) thus disturbing the interference pattern. The QED pairs alone would correspond to passing of light without the glass in front of the slit. The interference between $\rho(2\pi) \rightarrow e^+e^-$ and $\omega(3\pi) \rightarrow e^+e^-$ and the interference between $\rho(2\pi) \rightarrow 2\pi$ and $\omega(3\pi) \rightarrow 2\pi$ are measurements of strength of isospin non-conservation in electromagnetic interactions [13].

In the course of these experiments, since the width of ω is ~ 10 MeV and φ is ~ 5 MeV, we developed a detector with a mass resolution of ~ 5 MeV.

Some of the measurements have low event rates. In one particular experiment where we studied the e^+e^- mass spectra in the mass region above the ρ and ω mesons, the yield of e^+e^- pairs was about one event per day, with the full intensity of the accelerator. This implies that for about half a year the whole laboratory was working on this experiment alone. The rate of one event per day also implies that often there were no events for 2-3 days, and then on other days we had 2-3 events. It was during the course of this experiment that we developed the tradition of checking all voltages manually every 30 minutes, and calibrating the spectrometer by measuring the QED yields every 24 hours. To ensure that the detector was stable, we also established the practice of having physicists on shift, even when the accelerator was closed down for maintenance, and never switched off any power supplies. The net effect of this is that for many years our counting room has had a different grounding system from that of the rest of the laboratory. The Control Room for this series of experiments is shown in Fig. 2.

Some of the quantitative results from the above experiments may be explained if we assume that there are three kinds of fundamental building blocks

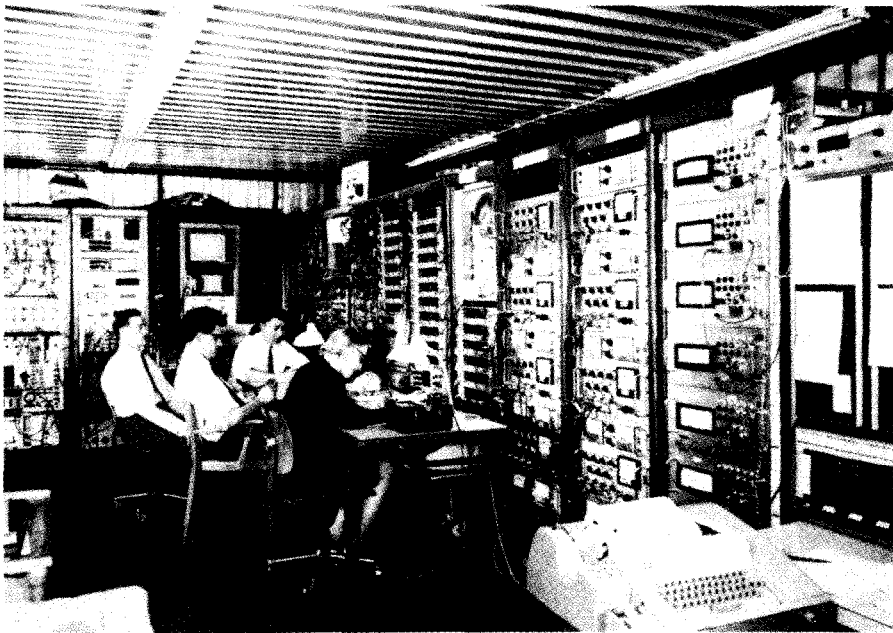

Fig. 2. Earlier Control Room at DESY. The three other people in the picture are Miss I. Schulz, Dr. U. Becker and Dr. M. Rohde. All have worked with me during the last 10 years.

in the world, known as quarks, which combine to form various elementary particles. The interactions between photons, heavy photons, and nuclear matter are results of interactions of the various quarks.

Sakurai [14] was the first to propose that the electromagnetic interaction of elementary particles may be viewed as through the heavy photon (vector meson) intermediate states.

2. NEW PARTICLES

After many years of work, we have learnt how to handle a high intensity beam of $\sim 10^{11} \gamma/s$ with a 2–3% duty cycle, at the same time using a detector that has a large mass acceptance, a good mass resolution of $\Delta M \approx 5 \text{ MeV}$, and the ability to distinguish $\pi\pi$ from e^+e^- by a factor of $> > 10^8$.

We can now ask a simple question: How many heavy photons exist? and what are their properties? It is inconceivable to me that there should be only three of them, and all with a mass around 1 GeV. To answer these questions, I started a series of discussions among members of the group on how to proceed. I finally decided to first perform a large-scale experiment at the 30 GeV proton accelerator at Brookhaven National Laboratory in 1971, to search for more heavy photons by detecting their e^+e^- decay modes up to a mass (m) of 5 GeV. Figure 3 shows the photocopy of one page of the proposal; it gives some of the reasons I presented, in the spring of 1972, for performing an e^+e^- experiment in a proton beam rather than in a photon beam, or at the DESY colliding beam accelerator then being constructed.

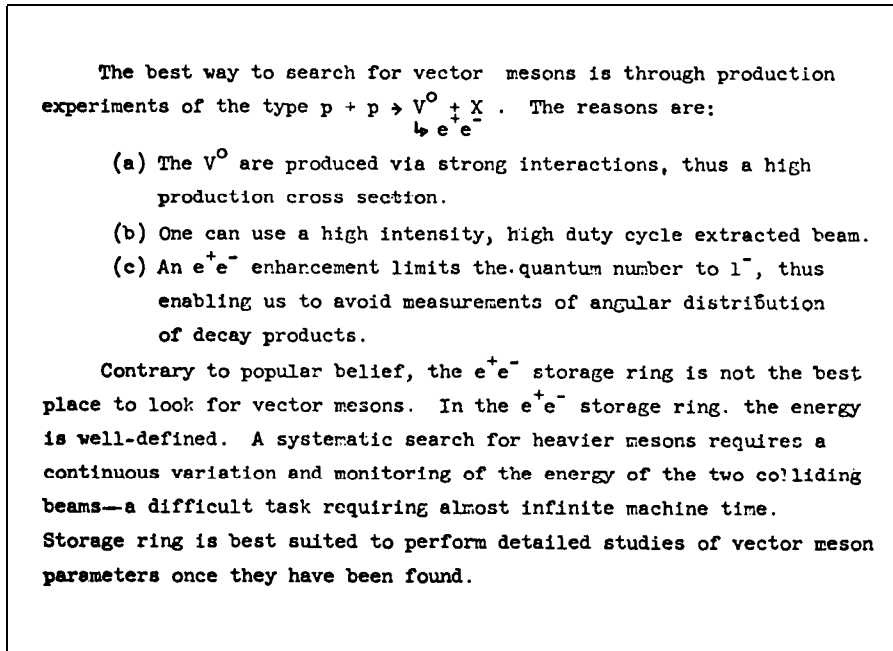

Fig. 3. Page 4 of proposal 598 submitted to Brookhaven National Laboratory early in 1972 and approved in May of the same year, giving some of the reasons for performing this experiment in a slow extracted proton beam.

Historically, to my knowledge, the Zichichi Group was the first one to use hadron-hadron collisions to study e^+e^- yields from proton accelerators [15]. This group was the first to develop the earlier shower development method so as to greatly increase the e/x rejection [16]. In later years the Lederman Group made a study of the $\mu^+\mu^-$ yield from proton nuclei collisions [17]. Some of the early theoretical work was done by Preparata [18], Drell and Yan [19], and others.

Let me now go to the J-particle experiment [20 - 22].

I. To perform a high-sensitivity experiment, detecting narrow-width particles over a wide mass range, we make the following four observations.

- i) Since the e^+e^- come from electromagnetic processes, at large mass m , the yield of e^+e^- is lower than that of hadron pairs ($\pi^+\pi^-$, K^+K^- , $\bar{p}p$, $K^+\bar{p}$, etc.) by a factor $\ll 10^6$.
- ii) Thus, to obtain sufficient e^+e^- rates, a detector must be able to stand a high flux of protons, typically of 10^{11} - 10^{12} protons/s, and
- iii) it must be able to reject hadron pairs by a factor of $\gg 10^8$.
- iv) For a detector with finite acceptance, there is always the question of where is the best place to install it to look for new particles. *A priori* we do not know what to do. But we do know that in reactions where ordinary hadrons are produced, the yield is maximum when they are produced at rest in the centre-of-mass system [23]. If we further restrict ourselves to

the $90^\circ e^+e^-$ decay of new particles, then we quickly arrive at the conclusion that the decayed e^+ or e^- emerge at an angle of 14.6° in the laboratory system for an incident proton energy of 28.3 GeV, independent of the mass of the decaying particle.

II. Figure 4 shows the layout of the slow-extracted intense proton beam from the Alternating Gradient Synchrotron (AGS) at Brookhaven, during the period 1973-1974. Our experiment (No. 598) was located in a specially designed beam line (the A-line). To design a clean beam with small spot sizes, I remembered having a conversation with Dr. A. N. Diddens of CERN who had used a slow-extracted beam at the CERN Proton Synchrotron. He advised me to focus the beam with magnets alone without using collimators.

The incident beam of intensity up to 2×10^{12} protons per pulse was focused to a spot size of $3 \times 6 \text{ mm}^2$. The position of the beam was monitored by a closed-circuit TV. The stability and the intensity of the beam were monitored by a secondary emission counter and six arrays of scintillation counter telescopes, located at an angle of 75° with respect to the beam, and buried behind 12 feet of concrete shielding. Daily calibrations were made of the secondary emission counter with the Al and C foils.

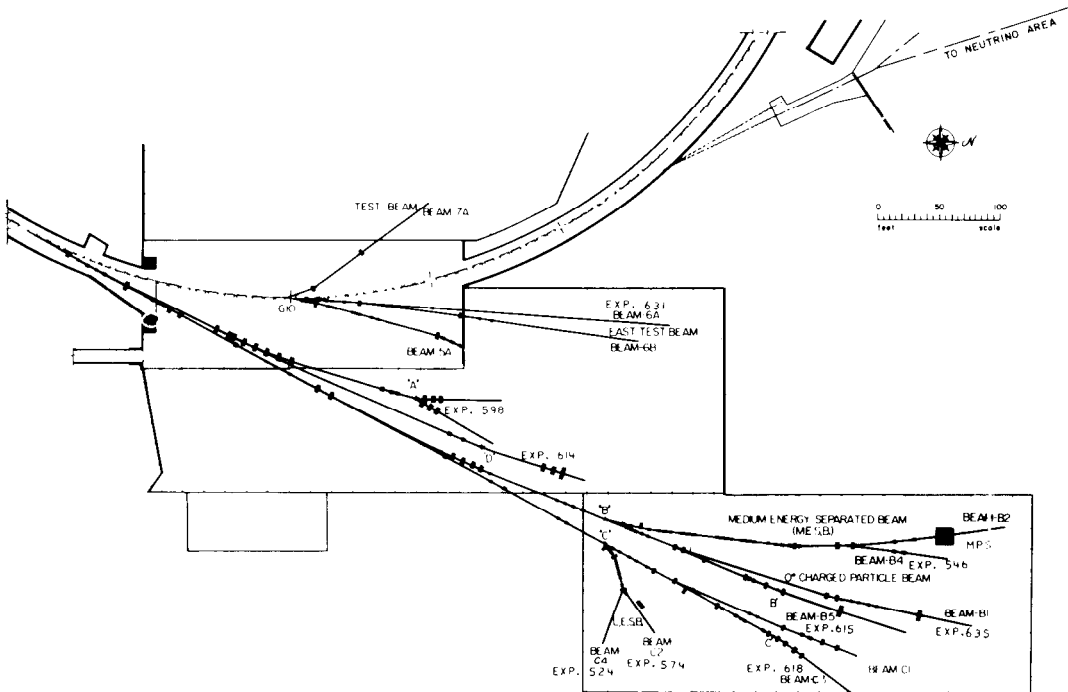

Fig. 4. The AGS East experimental area. The MIT experiment is No. 598 at the end of Station A. Experiment 614 is that of Prof. M. Schwartz (see Ref. 22).

III. From our early experience at DESY, we felt the best way to build an electron-pair detector that could handle high intensities, and at the same time have a large mass acceptance and a good mass resolution, is to design a large double-arm spectrometer and to locate most of the detectors behind the magnets so that they would not "view" the target directly. To simplify analysis and to obtain better mass resolution, we used the " p, θ independent" concept in which the magnets bend the particles vertically to measure their momentum, while the production angles are measured in the horizontal plane. Figures 5a and 5b show the plan and side views of the spectrometer and detectors.

The main features of the spectrometer are the following:

- 1) *The target:* The target consists of nine pieces of 1.78 mm thick beryllium, each separated by 7.3 cm so that particles produced in one piece and accepted by the spectrometer do not pass through the next piece. This arrangement also helps us to reject pairs of accidentals by requiring two tracks to come from the same origin.
- 2) *The magnet system:* The bending powers of the dipole magnets M_0 , M_1 , M_2 , are such that none of the counters sees the target directly. The field of the magnets in their final location was measured with a three-dimensional Hall probe at a total of 10^5 points.

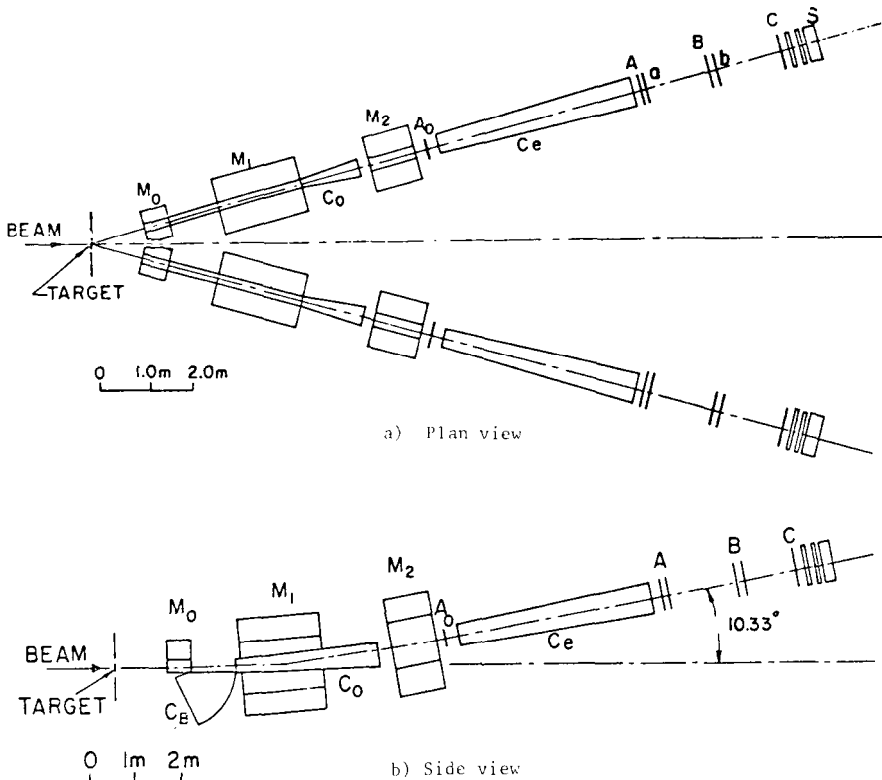

Fig. 5. Schematic diagram of the experimental set-up for the double-arm spectrometer used in our discovery of the J particle. M_0 , M_1 , and M_2 are dipole magnets; A_0 , A , B , and C are 8000-wire proportional chambers; a and b are each 8×8 hodoscopes; S designates three banks of lead-glass and shower counters; C_B , C_0 , and C_C are gas Čerenkov counters.

3) *The chambers:* A_v , A, B, and C are multiwire proportional chambers. They consist of more than 8000 very fine, $20\mu\text{m}$ thick, gold-plated wires, 2 mm apart, each with its own amplifier and encoding system. The wire arrangement is shown in Fig. 6. The 11 planes all have different wire orientation. In each of the last three chambers the wires are rotated 60° with respect to each other, so that for a given hit, the numbers of wires add up to a constant - a useful feature for sorting out multitracks and rejecting soft neutrons and γ -rays which do not fire all planes. We developed special gas mixtures to operate the chambers at low voltage and high radiation environment. To help improve the timing resolution, two planes of thin (1.6 mm thick hodoscopes (8×8)) are situated behind each of the chambers A and B. These chambers are able to operate at a rate of ~ 20 MHz and are also able to sort out as many as eight particles simultaneously in each arm.

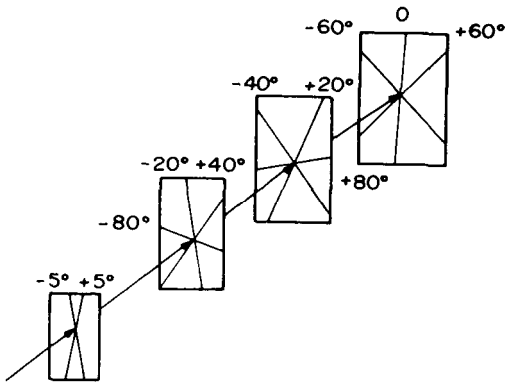

Fig. 6. Relative orientation of the planes of wires in the proportional chambers.

It is essential that all 8000 wires should function properly because to repair a single wire would involve removing close to a thousand tons of concrete.

These chambers and the magnets yield a mass resolution of ± 5 MeV and a mass acceptance of 2 GeV at each magnet current setting. The good mass resolution makes it possible to identify a very narrow resonance. The large mass acceptance is very important when searching over a large mass region for narrow resonances.

4) *Čerenkov counters and shower counters:* The Čerenkov counters marked C_v and C_s together with the lead-glass and shower counters marked S, enable one to have a rejection against hadron pairs by a factor of $> 1 \times 10^5$.

The Čerenkov counter in the magnet (C_v , see Fig. 7a) has a large spherical mirror with a diameter of 1 m. This is followed by another Čerenkov counter behind the second magnet with an elliptical mirror of dimensions 1.5×1.0 m². The Čerenkov counters are filled with hydrogen gas so that the knock-on electrons are reduced to the minimum. As in our earlier DESY experiments, the separation of the two counters by strong magnetic fields ensures that the

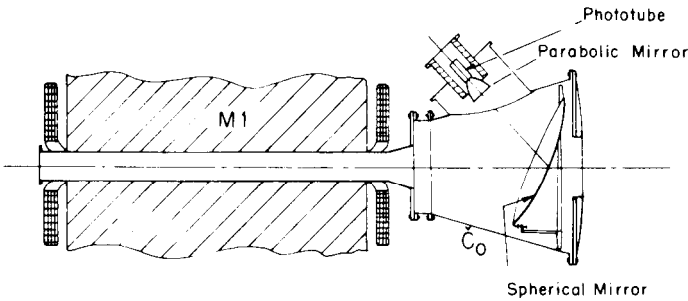

Fig. 7a.. Plan view of the C_0 counter shown in its location in the experiment

small number of knock-on electrons produced in the first counter is swept away and does not enter into the second counter.

To reduce multiple scattering and photon conversion, the material in the beam is reduced to a minimum. The front and rear windows of C_0 are $126\ \mu\text{m}$ and $250\ \mu\text{m}$ thick, respectively. To avoid large-angle Čerenkov light reflection, the mirrors of C_0 and C_e are made of 3 mm thick black lucite, aluminized on the forward (concave) surface only. The mirrors in the experiment were made at the Precision Optical Workshop at CERN. We measured the curvature of the mirrors with a laser gun, and out of the many mirrors that were made a total of 24 were used in this experiment (4 in C_0 , 4 in C_e , 16 in C_b).

The counters are painted black inside so that only the Čerenkov light from electrons along the beam trajectory will be focused onto the photomultiplier cathode. Special high-gain, high-efficiency phototubes of the type RCA C31000M are used, so that when we fill the counter with He gas as radiator (where we expect, on the average, 2-3 photoelectrons) we are able to locate the single photoelectron peak (see Fig. 7b).

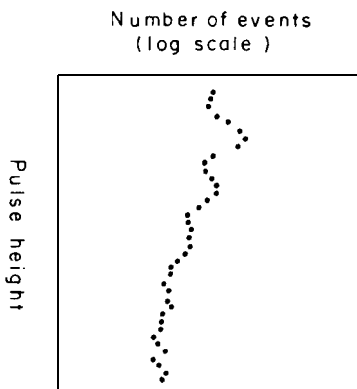

Fig. 7b. Pulse-height spectrum from the phototube (RCA C31000M) of the C_0 Čerenkov counter with He as radiator. Clearly visible are the one, two, and three photoelectron peaks.

The counter C_0 is very close to the target, which is a high-radiation-level area. To reduce random accidentals and dead-time, the excitation voltage on the photomultiplier has to be kept as low as possible. Yet we must still ensure that the counter is efficient. We have to avoid mistakingly setting the

voltage so low that the counter is only efficient on an e^+e^- pair from $\pi^0 \rightarrow \gamma + e^+ + e^-$, which may enter the counter. When C_0 is filled with hydrogen gas, a single electron will yield about eight photoelectrons, a pair will yield about sixteen. The knowledge of the location of one photoelectron peak enables us to distinguish between these two cases. The counters are all calibrated in a test beam to make sure they are 100% efficient in the whole phase space.

At the end of each arm there are two orthogonal banks of lead-glass counters of three radiation lengths each, the first containing twelve elements, the second thirteen, followed by one horizontal bank of seven lead-lucite shower counters, each ten radiation lengths thick, to further reject hadrons from electrons. The subdividing of the lead-glass and lead-lucite counters into ~ 100 cells also enables us to identify the electron trajectory from spurious tracks.

Figure 8 shows an over-all view of the detector with the roof removed. Figure 9 shows the end section of one arm of the detector, showing part of the Cerenkov counter C_0 , the proportional chambers, and counters.



Fig. 8. Over-all view of the detector.

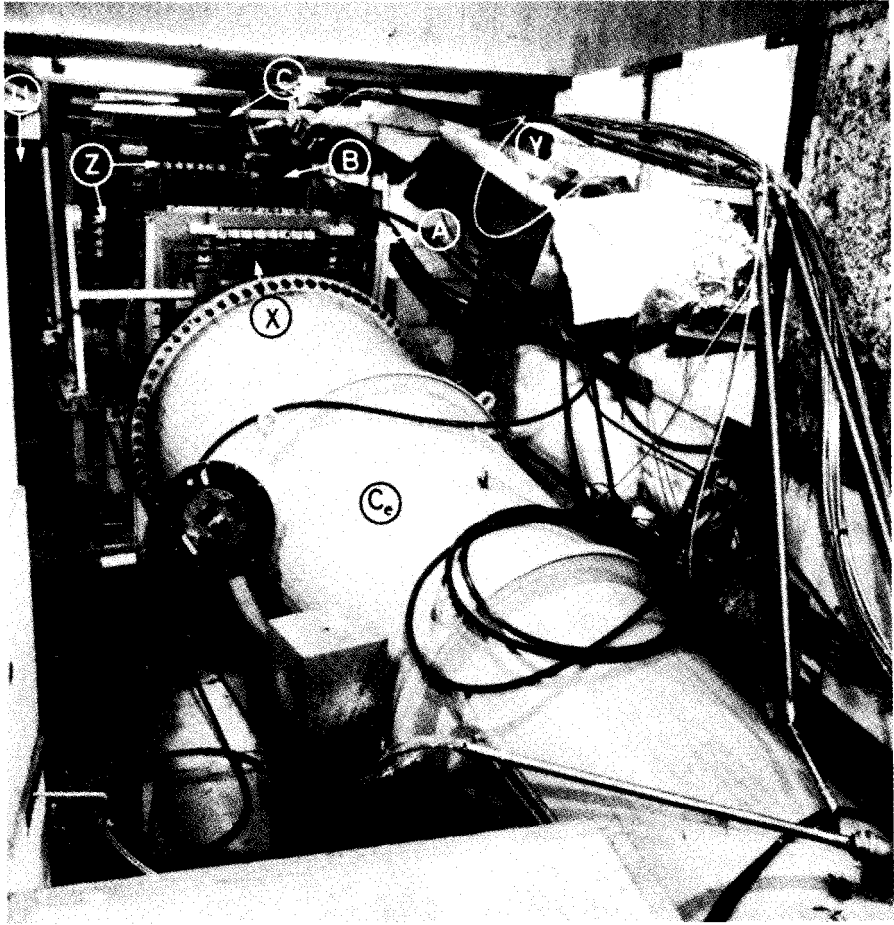
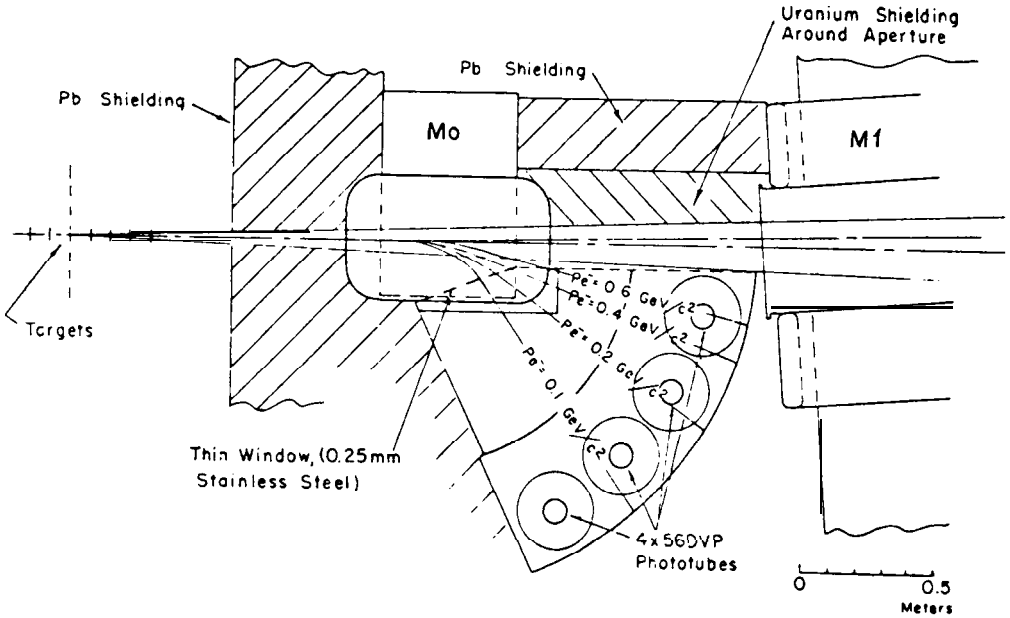
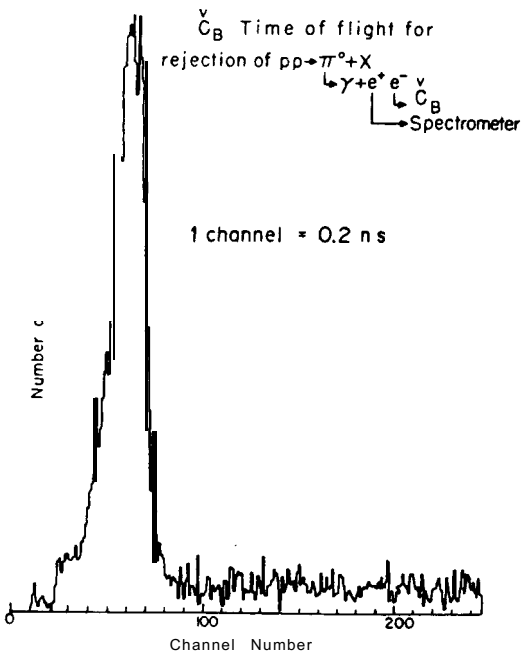

Fig. 9. End view of one arm, showing part of the Čerenkov counter C_e , the chambers A, B, C, with part of the 8000 amplifiers X, cables Y, and hodoscopes Z. The lead-glass counter is at the end of chamber U.

5) *A pure electron beam, for calibration:* To obtain a high rejection against hadron pairs and to ensure that the detectors are 100% efficient for electrons, we need to calibrate the detectors with a clean electron beam. In an electron accelerator such as DESY we can easily produce a clean electron beam with an energetic photon beam hitting a high- Z target thus creating $0^0 e^+e^-$ pairs. In a proton accelerator the best way to create a clean electron beam is to use the reaction $\pi^0 \rightarrow \gamma + e^+ + e^-$, tagging the e^+ in coincidence with the e^- . To accomplish this, the very directional Čerenkov counter C_a is placed close to the target and below a specially constructed magnet M_0 (Fig. 10a). This counter also is painted black inside; it is sensitive to electrons above 10 MeV/c and rejects pions below 2.7 GeV/c. The coincidence between C_a and C_{ν} , C_e , the shower counter, and the hodoscopes, indicates the detection of an e^+e^- pair from the process $\pi^0 \rightarrow \gamma + e^+ + e^-$. A typical plot of the relative timing of this coincidence is shown in Fig. 10b. We can trigger on C_a and provide a pure electron beam to calibrate C_{ν} , C_e , the lead-glass and shower counters.



a. Side view of magnet M_0 which bends the various low-energy trajectories (P_e) of e^+ into C_B .



b. The relative timing between an electron pulse from C_B and a positron trigger from the main spectrometer arm or vice versa.

Fig. 10. Measurement of e^+e^- from $\pi^0 \rightarrow \gamma + e^+ + e^-$ decay.

This is another way of setting the voltage of the C_0 counters, since the coincidence between C_c and C_b will ensure that the counter is efficient for a single electron and not a zero degree pair.

6) *Shielding*: As shown in Fig. 8 the detector is large, and with 10^{12} protons incident on a 10% collision length target there are $\sim 10^{12}$ particles generated around the experimental area. To shield the detector and the physicists, we constructed scaled-down wooden models of the concrete blocks, and soon realized that we would need more shielding than was available at Brookhaven. This problem was solved by obtaining all the shielding blocks from the Cambridge Electron Accelerator, which had just closed down. The total shielding used is approximately a) 10,000 tons of concrete, b) 100 tons of lead, c) 5 tons of uranium, d) 5 tons of soap-placed on top of C_0 , between M_1 and M_2 , and around the front of C_c to stop soft neutrons. Even with this amount of shielding, the radiation level in the target area, one hour after the shutting down of the proton beam, is still 5 röntgen/hour, a most dangerous level.

During the construction of our spectrometers, and indeed during the entire experiment, I encountered much criticism. The problem was that in order to gain a good mass resolution it was necessary to build a spectrometer that was very expensive. One eminent physicist made the remark that this type of spectrometer is only good for looking for narrow resonances-and there are no narrow resonances. Nevertheless, since I usually do not have much confidence in theoretical arguments, we decided to proceed with our original design.

In April 1974, we finished the set-up of the experiment and started bringing an intense-proton beam into the area. We soon found that the radiation level in our counting room was 0.2 röntgen/hour. This implied that our physicists would receive the maximum allowable yearly dose in 24 hours ! We searched very hard, for a period of two to three weeks, looking for the reason, and became extremely worried whether we could proceed with the experiment at all.

One day, Dr. U. Becker, who has been working with me since 1966, was walking around with a Geiger counter when he suddenly noticed that most of the radiation was coming from one particular place in the mountains of shielding. Upon close investigation we found out that even though we had 10,000 tons of concrete shielding blocks, the most important region-the top of the beam stopper - was not shielded at all! After this correction, radiation levels went down to a safe level and we were able to proceed with the experiment.

From April to August, we did the routine tune-ups and found the detectors performing as designed. We were able to use 10^{12} protons per second. The small pair spectrometer also functioned properly and enabled us to calibrate the detector with a pure electron beam.

IV. Owing to its complexity, the detector required six physicists to operate it. Before taking data, approximately 100 hours were spent ensuring that all the detectors were close to 100% efficient. I list some examples:

- i) The efficiency of the Čerenkov counters was measured over the whole phase space, and voltages set so that they were efficient everywhere. A typical result for C_c is shown in Fig. 11a.
- ii) The voltages and the response of all the lead-glass and shower counters were calibrated to ensure that the response did not change with time.
- iii) The efficiency of the hodoscopes at the far end, furthest away from the photomultiplier tube, was checked.
- iv) The timing of the hodoscopes was also checked to ensure that signals from each counter generated by particles produced at the target arrived simultaneously. During the experiment, the time-of-flight of each of the hodoscopes and the Čerenkov counters, the pulse heights of the Čerenkov counters and of the lead-glass and shower counters, the single rates of all the counters together with the wire chamber signals, were recorded and continuously displayed on a storage/display scope.
- v) To ensure that the proportional wire chambers were efficient over their whole area, a small test counter was placed behind the chambers at various positions over the chambers' area, and voltage excitation curves were made at those positions. A typical set of curves for all the planes is shown in Fig. 11b.
- vi) To check the timing between the two arms, two tests were performed. Firstly, the test counter was physically moved from one arm to the other

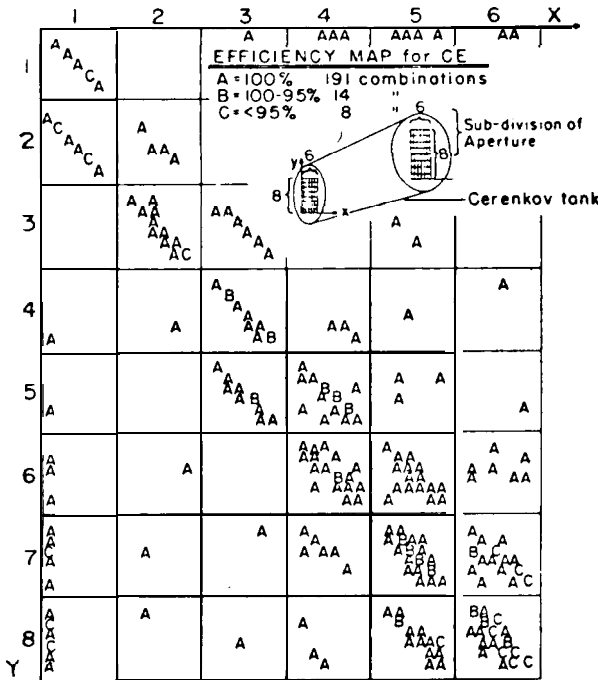

Fig. 11 a. Mapping of the efficiency of the C_c counter over its whole phase space. The letters on the plot refer to efficiencies measured for trajectories between the corresponding points marked on the grid at each end of the counter.

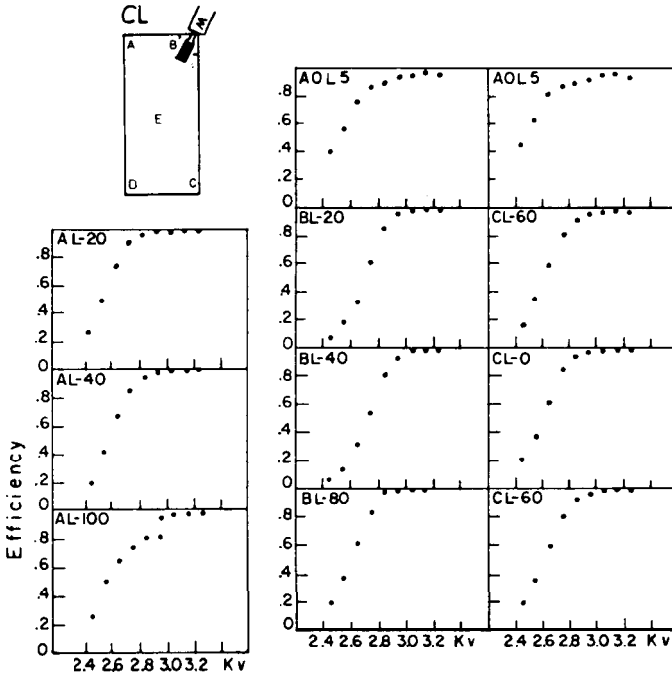

Fig. 11 b. Efficiency of all the wire planes as a function of the applied voltage. The measurements were done by placing a small test counter W in various positions, marked A, B, C, D, E, in every chamber.

so that the relative timing could be compared. Secondly, the e^+e^- yield was measured at low mass, $m_{ee} < 2 \text{ GeV}/c^2$, where there is an abundance of genuine e^+e^- pairs.

In the early summer of 1974 we took some data in the high mass region of 4-5 GeV. However, analysis of the data showed very few electron-positron pairs.

By the end of August we tuned the magnets to accept an effective mass of 2.5-4.0 GeV. Immediately we saw clean, real, electron pairs.

But most surprising of all is that most of the e^+e^- pairs peaked narrowly at 3.1 GeV (Fig. 12a). A more detailed analysis shows that the width is less than 5 MeV! (Fig. 12b).

Throughout the years, I have established certain practices in the group with regard to experimental checks on our data and on the data analysis. I list a few examples:

- i) To make sure the peak we observed was a real effect and not due to instrumentation bias or read-out error of the computer, we took another set of data at a lower magnet current. This has the effect of moving the particles into different parts of the detector. The fact that the peak remained fixed at 3.1 GeV (Fig. 12a) showed right away that a real particle had been discovered.
- ii) We used two completely different sets of programs to ensure that the analysis was correct. This means that two independent groups of physi-

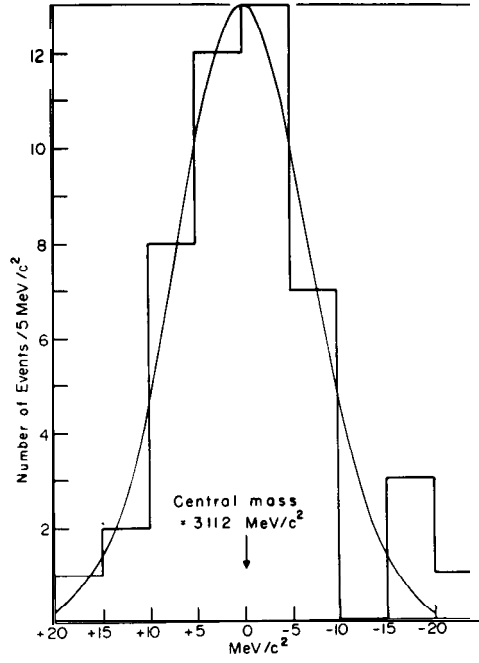
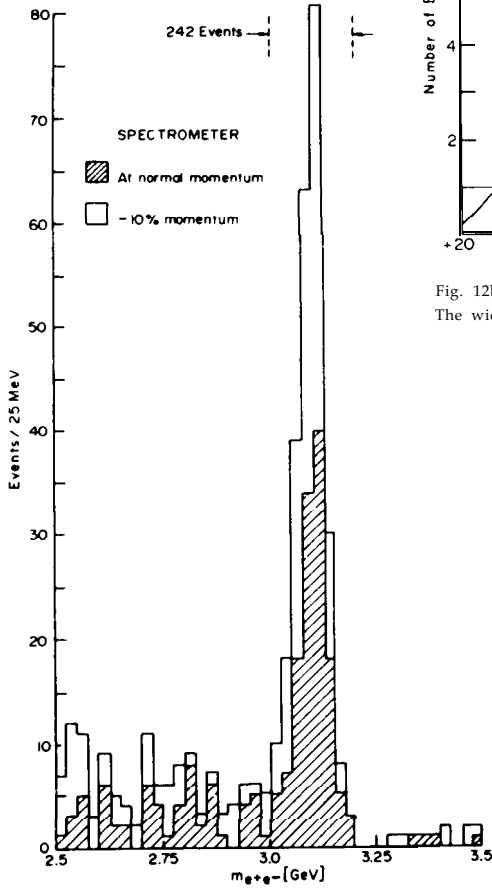

Fig. 12b. The measurement of the width of the J. The width is shown to be less than 5 MeV.

Fig. 12a Mass spectrum for events in the mass range $2.5 < m_{ee} < 3.5$ GeV/c. The shaded events correspond to those taken at the normal magnet setting, while the unshaded ones correspond to the spectrometer magnet setting at -10% lower than normal value.

cists analysed the data, starting from the reduction of raw data tapes, to form their own data summary tapes, and then performed two sets of Monte Carlo acceptance calculations, two sets of event reconstruction, two sets of data corrections, and finally, two sets of results which must agree with each other. Although this procedure uses twice as much computer time, it provides greater confidence in our results after the two independent approaches have reached the same conclusions.

- iii) To understand the nature of various second-order background corrections, we made the following special measurements:
- a) To check the background from pile-up in the lead-glass and shower counters, different runs were made with different voltage settings on the counters. No effect was observed in the yield.
 - b) To check the background from scattering from the sides of the magnets, cuts were made in the data to reduce the effective aperture. No significant reduction in the yield was found.
 - c) To check the read-out system of the chambers and the triggering system of the hodoscopes, runs were made with a few planes of chambers deleted and with sections of the hodoscopes omitted from the trigger. No unexpected effect was observed on the yield.
 - d) Since the true event rate is proportional to incident beam intensity and the accidental backgrounds from the two arms are proportional to the square of the incident intensity, a sensitive way to check the size of the background is to run the experiment again with different intensities. This was done and the background contribution in the peak was found to be unnoticeable.
- iv) To understand the nature of production properties of the new peak, we increased the target thickness by a factor of two. The yield increased by a factor of two, not by four.

These and many other checks convinced us that we had observed a real massive particle.

We discussed the name of the new particle for some time. Someone pointed out to me that the really exciting stable particles are designated by Roman characters - like the postulated W_0 , the intermediate vector boson, the Z_0 , etc. - whereas the "classical" particles have Greek designations like ρ, ω , etc. This, combined with the fact that our work in the last decade had been concentrated on the electromagnetic current $j_\mu(x)$, gave us the idea to call this particle the J particle.

V. I was considering announcing our results during the retirement ceremony for V. F. Weisskopf, who had helped us a great deal during the course of many of our experiments. This ceremony was to be held on 17 and 18 October 1974. I postponed the announcement. for two reasons. First, there were speculations on high mass e^+e^- pair production from proton-proton collisions as coming from a two-step process : $p+N \rightarrow \pi + \dots$, where the pion undergoes a second collision $\pi + N \rightarrow e^+ + e^- + \dots$. This could be checked by a measurement based on target thickness. The yield from a two-step process would

increase quadratically with target thickness, whereas for a one-step process the yield increases linearly. This was quickly done, as described in point (iv) above.

Most important, we realized that there were earlier Brookhaven measurements [24] of direct production of muons and pions in nucleon-nucleon collisions which gave the μ/π ratio as 10^4 , a mysterious ratio that seemed not to change from 2000 GeV at the ISR down to 30 GeV. This value was an order of magnitude larger than theoretically expected in terms of the three known vector mesons, ρ , ω , ϕ , which at that time were the only possible "intermediaries" between the strong and electromagnetic interactions. We then added the J meson to the three and found that the linear combination of the four vector mesons could not explain the μ^-/π^- ratio either. This I took as an indication that something exciting might be just around the corner, so I decided that we should make a direct measurement of this number. Since we could not measure the μ/π ratio with our spectrometer, we decided to look into the possibility of investigating the e^-/χ^- ratio.

We began various test runs to understand the problems involved in doing the e/π experiment. The most important tests were runs of different e^- momenta as a function of incident proton intensities to check the single-arm backgrounds and the data-recording capability of the computer.

On Thursday, 7 November, we made a major change in the spectrometer (see Fig. 13) to start the new experiment to search for more particles. We began by measuring the mysterious e/π ourselves. We changed the electronic logic and the target, and reduced the incident proton beam intensity by almost two orders of magnitude. To identify the e^- background due to the decay of π^0 mesons, we inserted thin aluminium converters in front of the spectrometer to increase the $\gamma \rightarrow e^+ + e^-$ conversion. This, together with the C_B counter which measures the $\pi \rightarrow \gamma + e^+ + e^-$ directly, enabled us to control the major e^- background contribution.

We followed the e/π measurements with another change in the spectrometer by installing new high-pressure Čerenkov counters and systematically measuring hadron pairs (K^+K^- , $\pi^+\pi^-$, $p\bar{p}$, etc.) to find out how many other particles exist that do not decay into e^+e^- but into hadrons. But, after a long search, none was found.

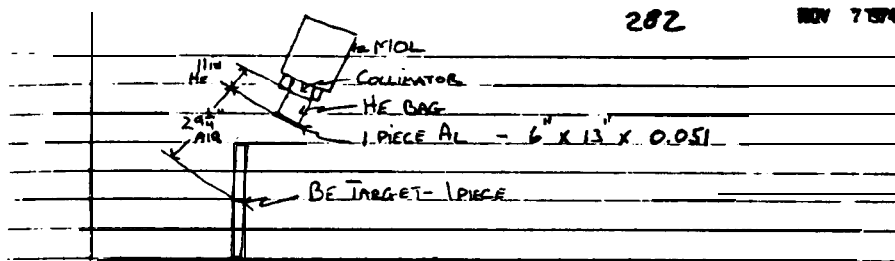

Fig. 13a. Aluminium foil arrangement in front of magnet M_0 in our new experiment to determine the e/π ratio. The converter was used to determine the electron background yield.

284

NOV 7 1974

1 ϕ ATTEN.

TRIGGER <u>CDI.CEI.EFGH</u>	MISC. SET _____	BEAM CONDITION _____
<u>SINGLE</u> ARM L OR R	CHECK HV _____	INTENSITY <u>2.4E0</u>
<u>EF</u> K AL B	He BAGS OK? _____	SPOT SIZE: _____
DOUBLE ARM _____	MOL _____	HEIGHT _____
CE PF MA EK B	MOR _____	CURRENT _____
TARGET: <u>1 x BB</u>	MIL _____	SOLE LENGTH _____
<u>2 foils A2</u>	MZL _____	OTHER _____
	MZA _____	
	PIPE _____	
	SEM-A1 VAC _____	
	SEM-A1 HV <u>8</u>	

CHAMBER CONDITION		CHERENKOV COATERS			
CHAMBER	HV	OTHER	GAS	PRESSURE	OTHERS
AOL		<u>ON</u>	COL		<u>ON</u>
AOR		<u>ON</u>	CBR		<u>ON</u>
AL			COL		
AR			CBR		
BL			COL		
BR			CBR		
CL					
CR					
METHYL	TEMP: _____		THICKNESS <u>29 μm</u>		
	FILL P: _____		MATERIAL _____		

TAPE: <u>DA 54</u>	MAGNET SETTINGS	PEOPLE ON SHIFTS
RUN# <u>221</u>	MOL <u>60.00</u>	<u>Tina</u>
DATE <u>NOV 7 1974</u>	MOR _____	<u>Kary</u>
TIME START: <u>21 50</u>	MIL <u>45-123</u>	<u>UW</u>
- STOP: <u>22 35</u>	MIR <u>45-123</u>	<u>Chen</u>
	MZL <u>26.212</u>	<u>Long</u>
	MZR <u>26.212</u>	
NOV 7 1974	MOMENTUM: <u>Mod P \ominus</u>	POLARITY <u>R-</u>
	COIL <u>ON</u>	

TSI SCALERS			
SEM-A1 _____	SEM _____		
G1 _____	G2 _____	G3 _____	G4 _____
MA _____			
MB _____			MAD _____
MC _____	REX _____		MR _____
MD _____	LEK _____		MLB _____
			NL _____

Fig. 13b. Data sheet for a typical run under the new experimental conditions. Blank spacers imply either data entered in the computer or conditions identical to the prior run. In this run the electrons pass through the right detector arm with a momentum of about 6 GeV. Two pieces of aluminium foil in front of the magnet M_0 serve as converters. [From the group's data book. pp. 282 and 284. 7 November 1974.]

In the meantime, since the end of October, M. Chen and U. Becker and others in the group had been insisting that we publish our results quickly. I was very much puzzled by the $\mu/\pi = 10^4$ ratio and wanted to know how many particles existed. Under pressure, I finally decided to publish our results of J alone.

On 6 November I paid a visit to G. Trigg, Editor of Physical Review Letters, to find out if the rules for publication without refereeing had been changed. Following that visit, I wrote a simple draft in the style of our quantum electrodynamics paper of 1967 (Ref. 5). The paper emphasized only the discovery of J. and the checks we made on the data without mention of our future plans.

On 11 November we telephoned G. Bellettini, the Director of Frascati Laboratory, informing him of our results. At Frascati they started a search on 13 November, and called us back on 15 November to tell us excitedly that they had also seen the J signal and obtained $\Gamma_{\mu\mu}^2/\Gamma_{\text{total}} = 0.8 \pm 0.2$ keV. Their first spectrum is shown in Fig. 14a. The Frascati Group were able to publish their results in the same issue of Physical Review Letters [25] as ours. Very shortly after, they made a more detailed study of J (Fig. 14b) and also established that its total width is only ~ 60 keV. (It lives ~ 1000 times longer than the ρ meson.) They have since made a systematic search for more particles at lower mass - but have found none [26].

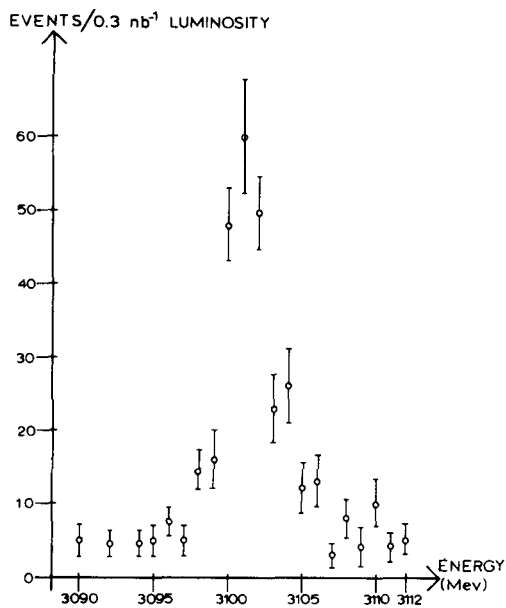

Fig. 14a. Result from one of the Frascati groups on J-particle production. The number of events per 0.3 nb^{-1} luminosity is plotted versus the total c.m. energy of the machine. (From Ref. 25.)

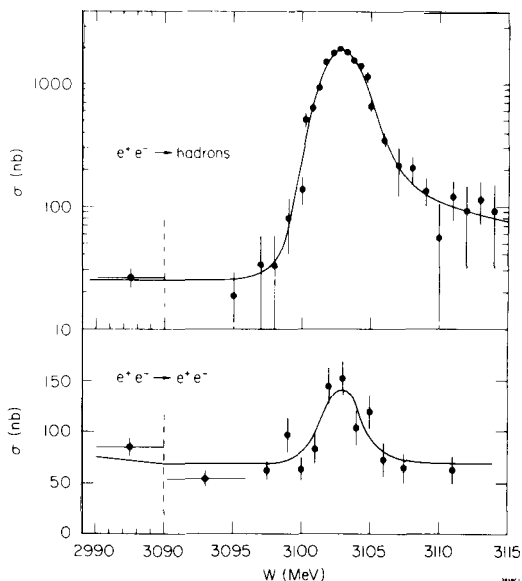

Fig. 14b. Excitation curves for the reactions $e^+e^- \rightarrow \text{hadrons}$ and $e^+e^- \rightarrow e^+e^-$.

The solid line represents the best fit to their data. (From Ref. 26.)

VI. Now, immediately after the discovery of J , because of its heavy mass and unusually long lifetime, there were many speculations as to the nature of this particle. Lee, Peoples, O'Halloran and collaborators [27] were able to photoproduce the J particle coherently from nuclear targets with an ~ 100 GeV photon beam. They showed that the photoproduction of the J is very similar to ρ production and thus were the first to establish that J is a strongly interacting particle.

Pilcher, Smith and collaborators [28] have ingeniously used a large acceptance spectrometer to perform an accurate and systematic study of J production at energies >100 GeV. By using π beams as well as proton beams, and by measuring a wide range of mass and the momentum transfer dependence of $\mu\mu$ production, they were the first to state that the single muon yield which produced the mysterious $\mu/\pi = 10^4$, which had puzzled me for a long time, comes mostly from the production of muon pairs. The J yield from the π mean seems to be much higher than from the proton.

In Fig. 13 arc listed some of the relative yields of J production from various proton accelerators. It seems that I had chosen the most difficult place to discover the J .

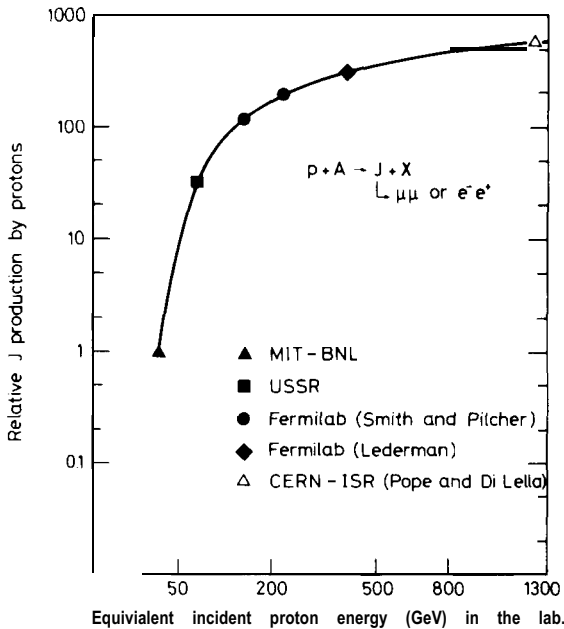

Fig 15. Relative J production, at 90° in the centre of mass, as a function of the energy of the incident proton beam. For experiments using nuclear targets, a linear A -dependence has been used to obtain the yield on a nucleon. Refs: MIT-BNL: J. J. Aubert et al., Phys. Rev. Letters 33, 1404 (1974) ; CERN-ISR: F. W. Büsler et al., Phys. Letters 56B, 482 (1975); USSR: Yu. M. Antipov et al., Phys. Letters 60B, 309 (1976) ; Lederman Group: H. D. Snyder et al., Phys. Rev. Letters 36, 1415 (1976) ; Smith-Pilcher Group: K. J. Anderson et al., paper submitted to the 18th Internat. Conf. on High-Energy Physics, Tbilisi, USSR (1976).

3. SOME SUBSEQUENT DEVELOPMENTS

The discovery of the J has triggered off many new discoveries. Some of the most important experimental work was done at SLAC [29] and at DESY [30].

The latest results [31] from the 4π superconducting magnet detector, called "Pluto", measuring the $e^+ + e^- \rightarrow \text{hadrons}$ near the mass of ψ' (the sister state of J) first discovered at SLAC, are shown in Fig. 16a. The yield of ψ' (and of J) goes up by $>10^2$. It can be seen that an electron-positron storage ring is an ideal machine for studying these new particles. The same group has recently carried out a careful search for new particles at a higher mass region. Their accurate results, shown in Fig. 16b, confirm the indication by SLAC that there may be many more states in this high mass region.

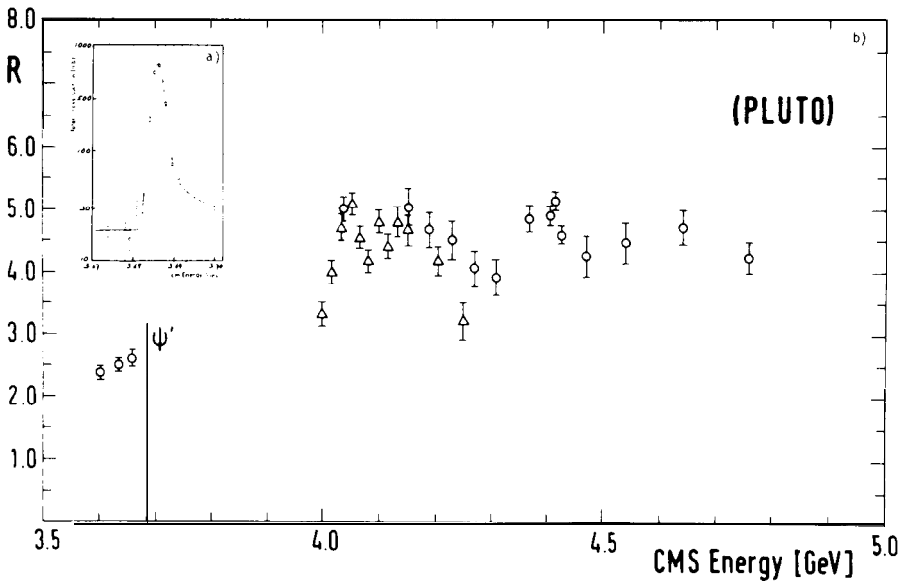
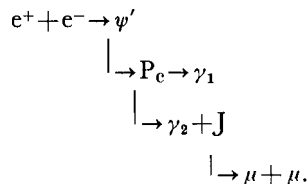

Fig. 16. a) Excitation curve for ψ' . b) Ratio $R = (e^+ + e^- \rightarrow \text{hadrons})$ over $(e^+ + e^- \rightarrow \mu^+ + \mu^-)$, measured by the DESY Pluto group. (Ref. 31.)

One of the most important discoveries after that of the J is the observation by the double-arm spectrometer (DASP) Group at DESY [32] of the chain reaction



By tuning the storage ring so that the electron-positron energy reaches 3.7 GeV to produce the ψ' , using the double-arm spectrometer to select the $\text{J} \rightarrow \mu^+ + \mu^-$ events and detecting both the γ_1 and γ_2 as well, they found that the two photons γ_1 and γ_2 are strongly correlated into two groups. The first group has $E_{\gamma_1} = 169 \pm 7$ MeV and $E_{\gamma_2} = 398 \pm 7$ MeV (or vice versa, since they did not

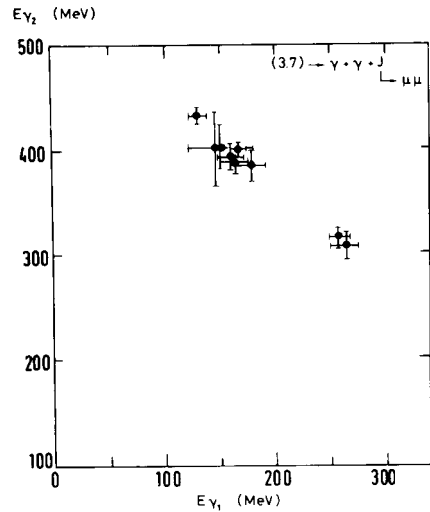

Fig. 17. Scatter plot of the two-photon energies for candidates for the decay $\psi' \rightarrow (J \rightarrow \mu^+ + \mu^-) + \gamma + \gamma'$. (Ref. 32.)

determine which γ came first), and the second group has $E_{\gamma_1} = 263 \pm 8$ MeV and $E_{\gamma_2} = 315 \pm$ MeV. This correlation, called scatter plot, is shown in Fig. 17. The emission of monochromatic γ -rays indicates the existence of intermediate states with even-spin quantum number.

The narrow width of the J and the existence of the P_c and many other states, strongly suggests that the J may be a bound state of two new quarks. The existence of charmed quarks was first proposed by Bjorken and Glashow [33], and Glashow, Iliopoulos and Maiani [34], originally as a cure for certain difficulties in the weak interaction of hadrons. Indeed, the energy levels of the observed states are very similar to the positronium state discovered by Deutsch in 1951 [35].

Recently there are indications from experiments at BNL [36], from DESY [37, 38], from the Fermi Laboratory [39] and from SLAC [40] of the existence of further narrow states, indications which very much follow the general prediction of Glashow.

4. CONCLUSION

In conclusion, we can ask ourselves some further questions:

- 1) We know that the photon transforms itself into ρ , ω , and ϕ with a mass of about 1 GeV. It can transform into J and its various associated states with a mass of about 3 - 5 GeV. What happens when we go to higher and higher energies? It seems very unlikely that there should not be many more new series of photon-like particles.
- 2) The existence of J implies that we need at least four quarks to explain the phenomena observed so far. How many more quarks will we need if we find a new series of particles in higher energy regions?
- 3) If we need a large family of quarks, are they the real fundamental blocks of nature? Why has none of them been found?

REFERENCES

1. See for example: J. Needham, *Science and civilization in China* (Cambridge University Press, New York, 1962), Vol. 4.
2. G. Herzberg, *Atomic spectra and atomic structure* (Dover Reprint, New York, 1944). A. I. Akhiezer and V. B. Berestetskii, *Quantum electrodynamics* (translated by Oak Ridge Technical Information Service, ORNL, Tennessee, USA, 1957). S. D. Drell, *Ann. Phys.* 4, 75 (1958).
3. S. J. Brodsky and S. C. C. Ting, *Phys. Rev.* 145, 1018 (1966).
4. J. Bailey, K. Borer, F. Combley, H. Drumm, C. Eck, F. J. M. Farley, J. H. Field, W. Flegel, P. M. Hattersley, F. Krienen, F. Lange, G. Petrucci, E. Picasso, H. I. Pizer, O. Runolfsson, R. W. Williams and S. Wojcicki, *Phys. Letters* 55B, 420 (1975). E. Picasso, private communication.
5. J. G. Asbury, W. K. Bertram, U. Becker, P. Joos, M. Rohde, A. J. S. Smith, S. Friedlander, C. Jordan and S. C. C. Ting, *Phys. Rev. Letters* 18, 65 (1967). H. Alvensleben, U. Becker, W. K. Bertram, M. Binkley, K. Cohen, C. L. Jordan, T. M. Knasel, R. Marshall, D. J. Quinn, M. Rohde, G. H. Sanders and S. C. C. Ting, *Phys. Rev. Letters* 21, 1501 (1968).
6. J. G. Asbury, U. Becker, W. K. Bertram, P. Joos, M. Rohde, A. J. S. Smith, C. L. Jordan and S. C. C. Ting, *Phys. Rev. Letters* 19, 869 (1967).
7. For theoretical papers on leptonic decay of vector mesons, see:
M. Gell-Mann, D. Sharp and W. G. Wagner, *Phys. Rev. Letters* 8, 261 (1962).
S. L. Glashow, *Phys. Rev. Letters* 7, 469 (1961).
M. Gell-Mann and F. Zachariasen, *Phys. Rev.* 124, 953 (1961).
Y. Nambu and J. J. Sakurai, *Phys. Rev. Letters* 8, 79 (1962).
S. M. Berman and S. D. Drell, *Phys. Rev. B* 133, 791 (1964).
N. M. Kroll, T. D. Lee and B. Zumino, *Phys. Rev.* 157, 1376 (1967).
H. Joos, *Phys. Letters* 24B, 103 (1967).
8. See also: J. K. de Pagter, J. I. Friedman, G. Glass, R. C. Chase, M. Gettner, E. von Goeler, R. Weinstein and A. M. Boyarski, *Phys. Rev. Letters* 16, 35 (1966). A. Wehman, E. Engels, L. N. Hand, C. M. Hoffman, P. G. Innocenti, R. Wilson, W. A. Blanpied, D. J. Drickey and D. G. Stairs, *Phys. Rev. Letters* 18, 929 (1967). B. D. Hyams, W. Koch, D. Pellett, D. Potter, L. von Lindern, E. Lorenz, G. Lütjens, U. Stierlin and P. Weilhammer, *Phys. Letters* 24B, 634 (1967). M. N. Khachatryan, M. A. Azimov, A. M. Baldin, A. S. Belousov, I. V. Chuvilo, R. Firkowski, J. Hladky, M. S. Khvastunov, J. Manta, A. T. Matyushin, V. T. Matyushin, G. A. Ososkov, L. N. Shtarkov and L. I. Zhuravleva, *Phys. Letters* 248, 349 (1967).
9. H. Alvensleben, U. Becker, W. K. Bertram, M. Chen, K. J. Cohen, T. M. Knasel, R. Marshall, D. J. Quinn, M. Kohde, G. H. Sanders, H. Schubel and S. C. C. Ting, *Phys. Rev. Letters* 24, 786 (1970).
10. H. Alvensleben, U. Becker, M. Chen, K. J. Cohen, R. T. Edwards, T. M. Knasel, R. Marshall, D. J. Quinn, M. Rohde, G. H. Sanders, H. Schubel and S. C. C. Ting, *Phys. Rev. Letters* 25, 1377 (1970).
11. H. Alvensleben, U. Becker, W. K. Bertram, M. Chen, K. J. Cohen, R. T. Edwards, T. M. Knasel, R. Marshall, D. J. Quinn, M. Rohde, G. H. Sanders, H. Schubel and S. C. C. Ting, *Phys. Rev. Letters* 25, 1373 (1970).
12. H. Alvensleben, U. Becker, W. Busza, M. Chen, K. J. Cohen, R. T. Edwards, P. M. Mantsch, R. Marshall, T. Nash, M. Rohde, H. F. W. Sadrozinski, G. H. Sanders, H. Schubel, S. C. C. Ting and S. L. Wu, *Phys. Rev. Letters* 27, 888 (1971).
13. For an excellent review of earlier work on ρ - ω interference, see G. Goldhaber, in *Experimental meson spectroscopy* (eds. C. Baltay and A. H. Rosenfeld) (Columbia Univ. Press, New York, 1970), p. 59. See also E. Gabathuler, same Proceedings, p. 645.

14. J. J. Sakurai, *Ann. Phys.* *11*, 1 (1960) and *Nuovo Cimento* *16*, 388 (1960). For an excellent review of earlier work, see H. Joos, Review talk at the Internat. Conf. on Elementary Particles, Heidelberg, 1967 (North-Holland Publ. Co., Amsterdam, 1968), p. 349.
15. M. Conversi, T. Massam, Th. Muller, M. A. Schneegans and A. Zichichi, Proc. 12th Internat. Conf. on High-Energy Physics, Dubna, 1964 (Atomizdat, Moscow, 1966), p. 895, and T. Massam, Th. Muller and A. Zichichi, *Nuovo Cimento* *40*, 589 (1965).
16. T. Massam, Th. Muller and A. Zichichi, CERN 63-25 (1963). See also, T. Massam, Th. Muller, M. Schneegans and A. Zichichi, *Nuovo Cimento* *39*, 464 (1965).
17. J. H. Christenson, G. S. Hicks, L. M. Lederman, P. J. Limon, B. G. Pope and E. Zavattini, *Phys. Rev. Letters* *25*, 1523 (1970).
18. One of the first theoretical works on dileptonic production from pp collisions is that of: G. Altarelli, R. A. Brandt and G. Preparata, *Phys. Rev. Letters* *26*, 42 (1971).
19. S. D. Drell and T. M. Yan, *Phys. Rev. Letters* *25*, 316 (1970).
20. J. J. Aubert, U. Becker, P. J. Biggs, J. Burger, M. Chen, G. Everhart, P. Goldhagen, Y. Y. Lee, J. Leong, T. McCorriston, T. G. Rhoades, M. Rohde, S. C. C. Ting and S. L. Wu, *Phys. Rev. Letters* *33*, 1404 (1974).
21. J. J. Aubert, U. Becker, J. J. Biggs, J. Burger, M. Chen, G. Everhart, J. W. Glenn III, P. Goldhagen, Y. Y. Lee, J. Leong, P. Mantsch, T. McCorriston, T. G. Rhoades, M. Rohde, S. C. C. Ting and S. L. Wu, *Nuclear Phys.* *B89*, 1 (1975).
22. See, S. C. C. Ting, *Discovery story in Adventures in Experimental Physics* *5*, 115 (1976).
23. T. T. Wu, private communication. V. Blobel, H. Fesefeldt, H. Franz, B. Hellwig, W. Idschok, J. W. Lamsa, D. Monkemeyer, H. F. Neumann, D. Roedel, W. Schrankel, B. Schwarz, F. Selonke and P. Soding, *Phys. Letters* *48B*, 73 (1974).
24. L. B. Leipuner, R. C. Larsen, L. W. Smith, R. K. Adair, H. Kasha, C. M. Ankenbrandt, R. J. Stefanski and P. J. Wanderer, *Phys. Rev. Letters* *34*, 103 (1975).
25. C. Bacci, R. Baldini Celio, M. Bernardini, G. Capon, R. Del Fabbro, M. Grilli, E. Iarocci, L. Jones, M. Locci, C. Mencuccini, G. P. Murtas, G. Penso, G. Salvini, M. Spano, M. Spinetti, B. Stella, V. Valente, B. Bartoli, D. Bisello, B. Esposito, F. Felicetti, P. Monacelli, M. Nigro, L. Paoluzi, I. Peruzzi, G. Piano Mortari, M. Piccolo, F. Ronga, F. Sebastiani, L. Trasatti, F. Vanoli, G. Barbarino, G. Barbiellini, C. Bemporad, R. Biancastelli, M. Calvetti, M. Castellano, F. Cevenini, V. Gostantini, P. Lariccia, S. Patricelli, P. Parascandolo, E. Sassi, C. Spencer, L. Tortora, U. Troya and S. Vitale, *Phys. Rev. Letters* *33*, 1408 (1974).
26. C. Bemporad, Proc. Internat. Symposium on Lepton and Photon Interactions at High Energies, Stanford, 1975 (SLAC, Calif., USA, 1975), p. 113.
27. B. Knapp, W. Lee, P. Leung, S. D. Smith, A. Wijangco, K. Knauer, D. Yount, D. Nease, J. Bronstein, R. Coleman, L. Cornell, G. Gladding, M. Gormley, R. Messner, T. O'Halloran, J. Sarracino, A. Wattenberg, D. Wheeler, M. Binkley, J. R. Orr, J. Peoples and L. Read, *Phys. Rev. Letters* *34*, 1040 and 1044 (1975). The group has recently finished a series of experiments on J production with a neutron beam on nuclear targets, and has learned valuable information on the transmission properties of J. M. Binkley, I. Gaines, J. Peoples, B. Knapp, W. Lee, P. Leung, S. D. Smith, A. Wijangco, J. Knauer, J. Bronstein, R. Coleman, G. Gladding, M. Goodman, M. Gormley, R. Messner, T. O'Halloran, J. Sarracino and A. Wattenberg, *Phys. Rev. Letters* *37*, 571 and 574 (1976).
28. K. J. Anderson, G. G. Henry, K. T. McDonald, J. E. Pilcher, E. I. Rosenberg, J. G. Branson, G. H. Sanders, A. J. S. Smith and J. J. Thaler, *Phys. Rev. Letters* *36*, 237 (1976), and *37*, 799 and 803 (1976).
29. See, for example, review papers by: R. F. Schwitters, Proc. Internat. Symposium on Lepton and Photon Interactions at High Energies, Stanford, 1975 (SLAC, Calif., USA, 1975), p. 5. G. S. Abrams, same Proceedings, p. 25. G. J. Feldman, same Proceedings, p. 39. A. D. Liberman, same Proceedings, p. 55.

30. For a review of DESY work, see: Review paper by B. H. Wiik, Proc. Internat. Symposium on Lepton and Photon Interactions at High Energies, Stanford, 1975 (SLAC, Calif., USA, 1975), p. 69.
31. J. Burmester, L. Criegee, H. C. Dehne, K. Derikum, R. Devenish, J. D. Fox, G. Franke, G. Flügge, Ch. Gerke, G. Horlitz, Th. Kahl, G. Knies, M. Rössler, G. Wolff, R. Schmitz, T. N. Rangaswamy, U. Timm, H. Wahl, P. Waloschek, G. G. Winter, W. Zimmermann, V. Blobel, H. Jensing, B. Koppitz, E. Lohrmann, A. Backer, J. Bürger, C. Grupin, M. Rost, H. Meyer and K. Wacker, DESY preprint 76/53 (1976). Also, E. Lohrmann, private communication.
32. W. Braunschweig, H.-U. Martyn, H. G. Sander, D. Schmitz, W. Sturm, W. Wallraff, K. Berkelman, D. Cords, R. Felst, E. Gadermann, G. Grindhammer, H. Hultschig, P. Joos, W. Koch, U. Kötz, H. Krehbiel, D. Kreinick, J. Ludwig, K.-H. Mess, K. C. Moffeit, A. Petersen, G. Poelz, J. Ringel, K. Sauerberg, P. Schmüser, G. Vogel, B. H. Wiik, G. Wolf, G. Buschhorn, R. Kotthaus, U. E. Kruse, H. Lierl, H. Oberlack, R. Pretzl, M. Schliwa, S. Orito, T. Suda, Y. Totsuka and S. Yamada, Phys. Letters 57B, 407 (1975).
33. B. J. Bjorken and S. L. Glashow. Phys. Letters II, 255 (1964). See also earlier paper by S. L. Glashow and M. Gell-Mann. Ann. Phys. 15, 437 (1961).
34. S. L. Glashow. J. Iliopoulos and L. Maiani. Phys. Rev. D 2, 1285 (1970).
35. M. Deutsch. Phys. Rev. 82, 455 (1951).
36. E. Cazzoli, A. M. Cnops, P. L. Connolly, R. I. Louttit, M. J. Murgtagh, R. B. Palmer, N. P. Samios, T. T. Tso and H. H. Williams, Phys. Rev. Letters 34, 1125 (1975).
37. W. Braunschweig, H.-U. Martyn, H. G. Sander, D. Schmitz, W. Sturm, W. Wallraff, D. Cords, R. Felst, R. Fries, E. Gadermann, B. Gittelmann, H. Hultschig, P. Joos, W. Koch, U. Kötz, H. Krehbiel, D. Kreinick, W. A. McNeely, K. C. Moffeit, P. Petersen, O. Römer, R. Rüscher, B. H. Wiik, G. Wolf, G. Grindhammer, J. Ludwig, K. H. Mess, G. Poelz, J. Ringel, K. Sauerberg, P. Schmitzer, W. De Boer, G. Buschhorn, B. Gunderson, R. Kotthaus, H. Lierl, H. Oberlack, M. Schliwa, S. Orito, T. Suda, Y. Totsuka and S. Yamada, Phys. Letters 63B, 471 (1976).
38. J. Burmester, L. Criegee, H. C. Dehne, K. Derikum, R. Devenish, J. D. Fox, G. Franke, G. Flügge, Ch. Gerke, G. Horlitz, Th. Kahl, G. Knies, M. Rössler, G. Wolff, R. Schmitz, T. N. Rangaswamy, U. Timm, H. Wahl, P. Waloschek, G. G. Winter, W. Zimmermann, V. Blobel, H. Jensing, B. Koppitz, E. Lohrmann, A. Backer, J. Bürger, C. Grupin, M. Rost, H. Meyer and K. Wacker, DESY preprint 76/50 (1976), and private communication from B. Wiik.
39. B. Knapp, W. Lee, P. Leung, S. D. Smith, A. Wijangco, J. Knauer, D. Yount, J. Bronstein, R. Coleman, G. Gladding, M. Goodman, M. Gormley, R. Messner, T. O'Halloran, J. Sarracino, A. Wattenberg, M. Binkley, I. Gaines and J. Peoples, Phys. Rev. Letters 37, 882 (1976).
40. G. Goldhaber, F. M. Pierre, G. S. Abrams, M. S. Alam, A. M. Boyarski, M. Breidenbach, W. C. Carithers, W. Chinowsky, S. C. Cooper, R. G. DeVoe, J. M. Dorfan, G. J. Feldman, C. E. Friedberg, D. Fryberger, G. Hanson, J. Jaros, A. D. Johnson, J. A. Kadyk, R. R. Larsen, D. Lüke, V. Lüth, H. L. Lynch, R. J. Madaras, C. C. Morehouse, H. K. Nguyen, J. M. Paterson, M. L. Perl, I. Peruzzi, M. Piccolo, T. P. Pun, P. Rapidis, B. Richter, B. Sadoulet, R. H. Schindler, R. F. Schwitters, J. Siegrist, W. Tanenbaum, G. H. Trilling, F. Vannucci, J. S. Whitaker and J. E. Wiss, Phys. Rev. Letters 37, 255 (1976). I. Peruzzi, M. Piccolo, G. J. Feldman, H. K. Nguyen, J. E. Wiss, G. S. Abrams, M. S. Alam, A. M. Boyarski, M. Breidenbach, W. C. Carithers, W. Chinowsky, R. G. DeVoe, J. M. Dorfan, G. E. Fischer, C. E. Friedberg, D. Fryberger, G. Goldhaber, G. Hanson, J. A. Jaros, A. D. Johnson, J. A. Kadyk, R. R. Larsen, D. Lüke, V. Lüth, H. L. Lynch, R. J. Madaras, C. C. Morehouse, J. M. Paterson, M. L. Perl, F. M. Pierre, T. P. Pun, P. Rapidis, B. Richter, R. H. Schindler, R. F. Schwitters, J. Siegrist, W. Tanenbaum, G. H. Trilling, F. Vannucci and J. S. Whitaker, Phys. Rev. Letters 37, 569 (1976).