

THE SVEDBERG

The ultracentrifuge

Nobel Lecture, May 19, 1927

Zsigmondy's pioneering ultramicroscopic research, which was awarded the 1925 Nobel Prize in Chemistry, confirmed that the colloidal solutions are a transitional sector between coarse suspensions and ordinary solutions. Zsigmondy's method in his own and other researchers' hands has helped us to a comprehensive knowledge of the size of colloidal particles. A reliable foundation for the study of colloids could not be laid until the ultramicroscope was constructed: the ultramicroscope showed that the colloids are disperse systems. Zsigmondy's method - although extremely valuable - does suffer from a twofold limitation however. Firstly, the ultramicroscope can be used to reveal the smallest particle sizes only with optically favourable material. The important lyophilic colloids in particular - for example ferric hydrate, silicic acid, protein, starch, cellulose, rubber - cannot as a rule be resolved in the ultramicroscope. Secondly, an ultramicroscopic study gives only very incomplete information concerning which different particle sizes are present in one and the same colloid. In other words, the distribution of the particle sizes cannot be determined. And it is precisely the lyophilic colloids and the finest grained amongst them that play the most important part in nature, and the distribution of their particle sizes is of the greatest interest to us.

In 1908 Perrin showed the applicability of Stokes' law to determination of particle sizes in coarse-grained disperse systems. In 1911 Estrup and the author showed the possibility of determining the distribution of the particle sizes by measuring the frictional resistance exerted against a single particle during its movement in the solution. The frictional resistance can be measured partly by dropping tests in the ultramicroscope and partly by measuring the Brownian movement.

In 1916 and the following year Odén succeeded, by using an automatically recording balance designed by himself, in preparing an elegant and reliable method of determining the particle-size distribution in coarsely disperse systems. His method is based on sedimentation in the gravitational field. It was an important step towards the solution of the general problem of determining the particle-size distribution in disperse systems in general.

It is, however, obvious that sedimentation analyses in the gravitational field can be carried out only on disperse systems consisting of relatively large particles of high specific gravity. To be able to study the actual colloids, the field of force must be increased many thousand times. This can be done by rotating the solution at high speed, i.e. by centrifugation. The only methods of observation applicable under such conditions are the optical. In 1922, Rinde and the author carried out tests with coarse-grained gold colloids in the gravitational field in order to try out the possibility of calculating the distribution of the particle-sizes optically by determining the changes of concentration in the solution during sedimentation. The changes of concentration were observed by means of light absorption in the solution. The method proved to be fully applicable. During the author's stay at Wisconsin University next year, Nichols and the author built a centrifuge to study the particle-size distribution. The concentration changes were observed by photographing the solution during rotation. The centrifugal force attained was only approximately 150 times gravity, so that it was possible to study only colloids of relatively low degree of dispersion. The particle-size of gold colloids down to ca. 20 μ radius was determined with this apparatus. Next year (1924) Rinde and the author built a centrifuge which enabled a field of force up to approximately 7,000 times gravity to be produced (maximum speed about 12,000 r.p.m.). With this apparatus - which we called the ultracentrifuge - it was possible to determine particle-sizes and the distribution of particle-sizes down to those which would be invisible in the ultramicroscope. In 1925-1926, after means had been made available from the Andersson Medical Research Fund and from the Nobel Chemical Fund, Lysholm and the author built a new ultracentrifuge which permitted the study of solutions in fields of force of up to about 100,000 times gravity (maximum speed of revolution 42,000 r.p.m.). With this ultracentrifuge it is possible to cover the entire sector of the colloids down to the smallest particle sizes and even penetrate slightly into the actual molecular solutions. In so doing we reach a field of the very greatest theoretical and practical importance, the substances of high molecular weight, such as haemoglobin, protein, starch, etc. The limit of the possible has not yet been reached. The author hopes that with a new ultracentrifuge it will be possible to double the field of force and thus link up the centrifugation method analysis with conventional molecular-weight analysis carried out on solutions by determining boiling or freezing point.

A centrifugal field can be utilized in two different ways to determine particle size and molecular weight. Firstly, the sedimentation speed itself can be measured, and secondly it is possible to study the state of equilibrium - the so-called sedimentation equilibrium - which is assumed after a relatively long period of centrifugation. Both these methods link up with the classical examinations of the behaviour of coarsely disperse systems in the gravitational field which were carried out in 1908 and the next year by Perrin and his colleagues and which were awarded the Nobel Prize in Physics in 1926.

Let us imagine a small quantity of a highly disperse colloidal solution enclosed in a wedge-shaped cell rotating at an angular velocity ω about an axis coinciding with the apex of the wedge.

Each particle is subject to the action of two different and opposed forces: centrifugal force, which is $v(\rho_p - \rho)\omega^2x$ and the frictional resistance which is $k \cdot dx/dt$, where v is the particle volume, ρ_p is the particle density, ρ is the solvent density, x is the distance of the particle from the axis of rotation, k the coefficient of friction, and dx/dt the speed of sedimentation. We therefore have:

$$v(\rho_p - \rho)\omega^2x = k \cdot dx/dt$$

If the particles can be regarded as being approximately spherical having radius r , then $v = 4/3\pi r^3$ and $k = 6\pi\eta r$, where η is the viscosity of the solvent. After substitution and integration:

$$r = \sqrt{\frac{9\eta \ln(x_2/x_1)}{2(\rho_p - \rho)\omega^2(t_2 - t_1)}}$$

If the substance has a high molecular weight, which will be denoted by M , the partial specific volume V_ρ , a molar coefficient of friction f and the coefficient of diffusion D , then we obtain instead the following equations

$$M(1 - V_\rho)\omega^2x = f \cdot dx/dt \text{ and } f = RT/D$$

whence :

$$M = \frac{RT \, dx/dt}{D(1 - V_\rho)\omega^2x}$$

or integrated :

$$M = \frac{RT \ln(x_2/x_1)}{D(1 - V\rho)\omega^2(t_2 - t_1)}$$

If centrifugation is carried out for a sufficient length of time, equilibrium is finally assumed between sedimentation and diffusion. In that case, formulae for the particle volume and for the molecular weight can be derived partly kinetically and partly thermodynamically. For the volume v , of the single particle we have:

$$v = \frac{2 RT \ln(c_2/c_1)}{N(\rho_p - \rho)\omega^2(x_2 - x_1)(x_2 + x_1)}$$

and for the molecular weight:

$$M = \frac{2 RT \ln(c_2/c_1)}{(1 - V\rho)\omega^2(x_2 - x_1)(x_2 + x_1)}$$

where c_2 and c_1 denote the concentrations at the points x_2 and x_1 .

Starting from the above formulae, it is possible to evolve methods of calculating the particle-size distribution. It would, however, take too long here to give an account of the mathematics used.

The centrifuge which was built by Rinde and the author and which permits observations in the field of force up to 7,000 times gravity has proved very suitable for the study of the sedimentation speed in reasonably highly disperse colloids and for a study of sedimentation equilibrium in extremely highly disperse colloids and crystalloids of high molecular weight. The solution or solutions to be studied is/are enclosed in plane parallel wedge-shaped rock crystal cells. Each test solution is covered with a layer of vacuum oil to prevent vaporization and convection currents originating therefrom. The cell holder together with the cells is placed in a rotor resting on the top of a vertical shaft mounted in a modified separator stand. To obtain a sufficiently constant temperature the step bearing of the vertical shaft is provided with a thermocouple-controlled cooling system, the rotor being surrounded by a hydrogen atmosphere. The friction in hydrogen is much less than in air, while in addition as a result of its high thermal conductivity hydrogen equal-

izes any temperature differences. The centrifuge housing is provided with two windows so that a beam of light can be applied through the solution during its rotation. Conditions at various times during centrifugation are determined by a camera. Photographic detection of the changes of concentration in the solution presupposes that the substance dissolved has absorption in the wavelength range of the illuminating light. Since only relatively few substances absorb in the visible part of the spectrum but most substances do so in the ultraviolet part, ultraviolet light in most cases has to be used for the photography. A suitable wavelength range can be isolated from a mercury-lamp radiation by means of filters containing chlorine and bromine.

A number of different concentrations of the same solution are photographed on the photographic plate bearing the exposures of the solution during centrifugation.

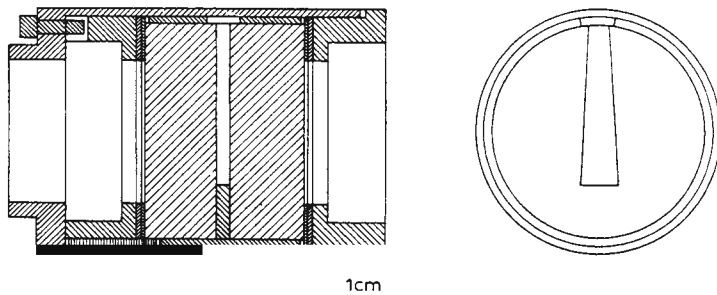

Fig. 1. Ultracentrifuge cell (longitudinal section and cross-section). The solution is enclosed in the plane-parallel wedge-shaped space between two glass or quartz plates.

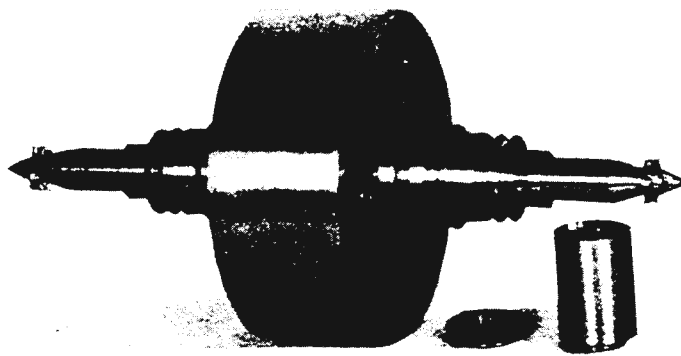

Fig. 2. The ultracentrifuge rotor with one of the cell cartridges removed.

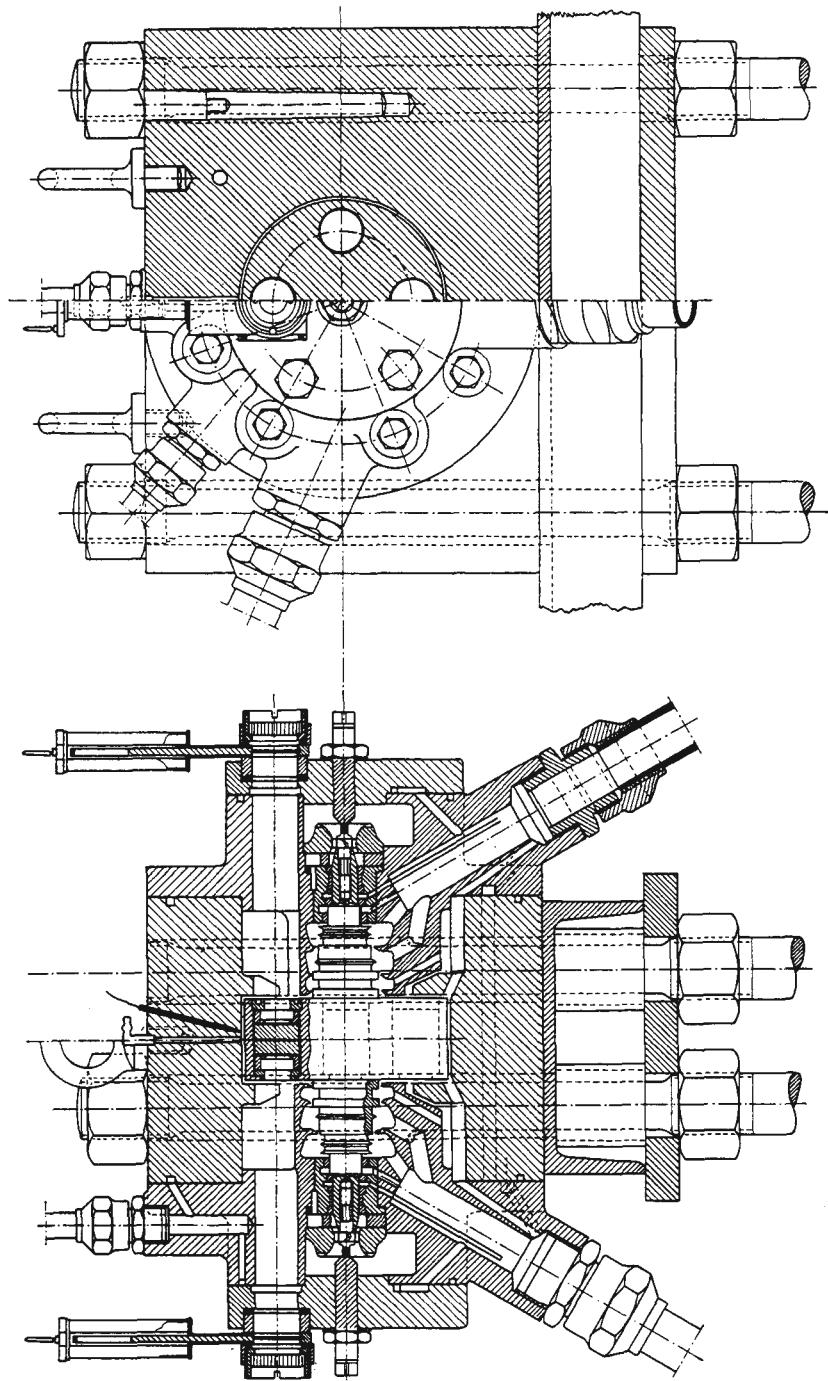

Fig. 3. The ultracentrifuge (longitudinal and cross-section).

After development, the plate is analysed by means of Siegbahn's self-recording microphotometer, and graphs are plotted to show the changes of concentration due to centrifugation.

As already stated, very strong fields of force are required for the study of the sedimentation speed in very highly disperse colloids. The ultracentrifuge which was built by Lysholm and the author in accordance with the

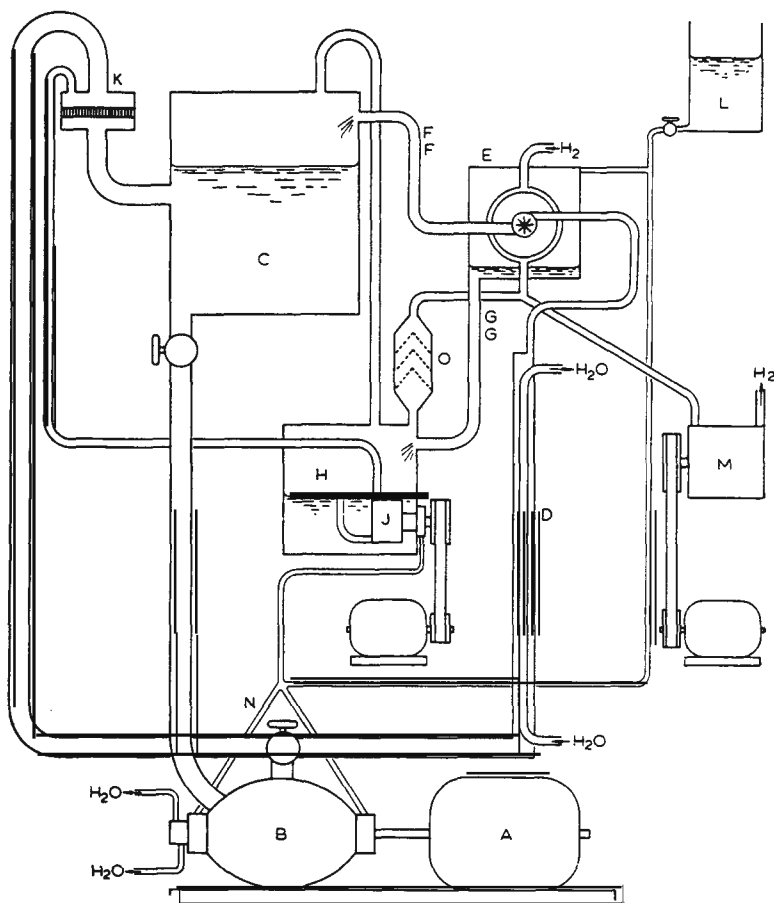

Fig. 4. The ultracentrifuge oil and hydrogen circulation system.

- | | |
|-----------------------------------|----------------------|
| (A) electric motor | (H) oil tank |
| (B) oil pump | (J) oil pump |
| (C) oil tank | (K) oil filter |
| (D) oil cooler | (L) sealing oil tank |
| (E) ultracentrifuge | (M) vacuum pump |
| (F) discharge pipe from turbines | (N) three-way cock |
| (CG) discharge pipe from bearings | (O) drip trap |

theories of F. Ljungström, and which permits observations in fields up to above 100,000 times gravity, is suitable for such examination. The cells have a circular outer contour and are cemented into steel sleeves (Fig. 1). Four such sleeves are introduced into and screwed fast in the rotor (Fig. 2) of chrome-nickel steel. The rotor is mounted horizontally and is rotated by means of two small oil turbines. Fig. 3 gives an idea of the construction of the centrifuge.

To keep the heating within reasonable limits, the rotor should rotate in hydrogen at a pressure of about 15 mm Hg. This point represents an optimum. The reason for this is that the frictional work drops with the pressure, while the thermal conductivity and hence the coolability, is constant down to a fairly low pressure. The bearings are cooled by a vigorous flow of oil and thermocouples are used to control the temperature. Fig. 4 is a diagram of the oil and hydrogen circulation system. Fig. 5 is a diagram of the illumination and photographic systems. The methods of observation are similar to those used with the smaller centrifuge. The rotor speed is read from a stroboscopic tachometer (on the right in Fig. 5).

The above-described apparatus has hitherto been used for examination of

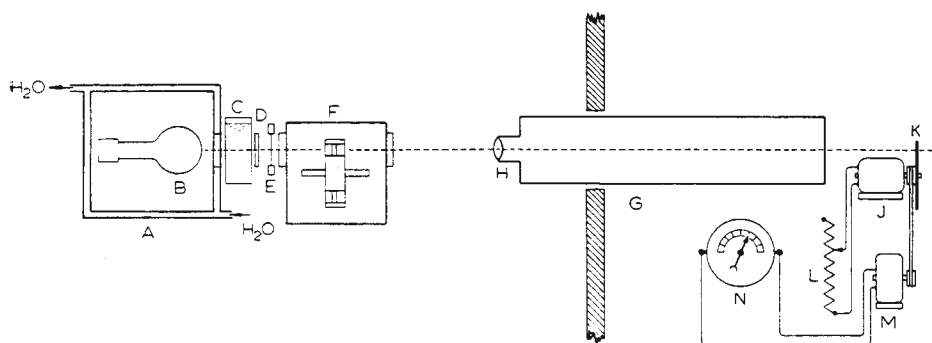

Fig. 5. Illumination and photographic system, together with stroboscopic tachometer, for the ultracentrifuge :

- | | |
|-------------------------------|-----------------------|
| (A) water-cooled lamp housing | (H) objective |
| (B) lamp | (J) motor |
| (C) water filter | (K) stroboscopic disc |
| (D) light filter | (L) resistor |
| (E) shutter | (M) generator |
| (F) ultracentrifuge | (N) hot-wire ammeter |
| (G) camera | graduated in r.p.m. |

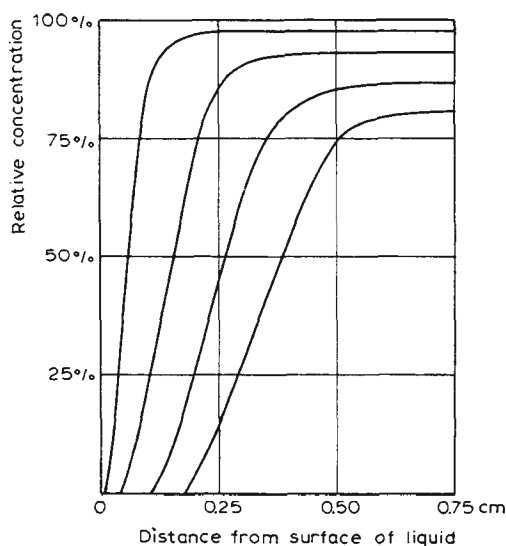

Fig. 6. Concentration distribution in a highly disperse gold colloid 5, 10, 15, 20 minutes after beginning of centrifugation; field of force 28,800 times gravity (according to H. Rinde).

synthetic inorganic colloids and for studies in connection with natural proteins.

Let us first consider the determination of the particle-size distribution in the gold colloids which are so well known from Zsigmondy's classic work. In this field Rinde has carried out exhaustive tests which have shown that these colloidal solutions are in no way as equal-grained as was previously thought. As an example we will choose the finest grained of all the gold colloids, the one reduced from chloroauric acid with phosphorus. Rinde has determined the particle distribution in such a solution partly by measuring the speed of sedimentation and partly by measuring the sedimentation equilibrium. Fig. 6 reproduces the concentration curves calculated from a series of exposures of such a colloid with sedimentation in a field 28,800 times gravity; the time between two exposures is 5 minutes.

Fig. 7 shows the distribution curve. As will be apparent from this curve, particles are present between 0.7 and 2.2 . The maximum is at about 1.5 . The sedimentation equilibrium for a similar gold colloid of rather coarser grain in a field 350 times gravity is reproduced diagrammatically in Fig. 8. Fig. 9 shows the distribution curve.

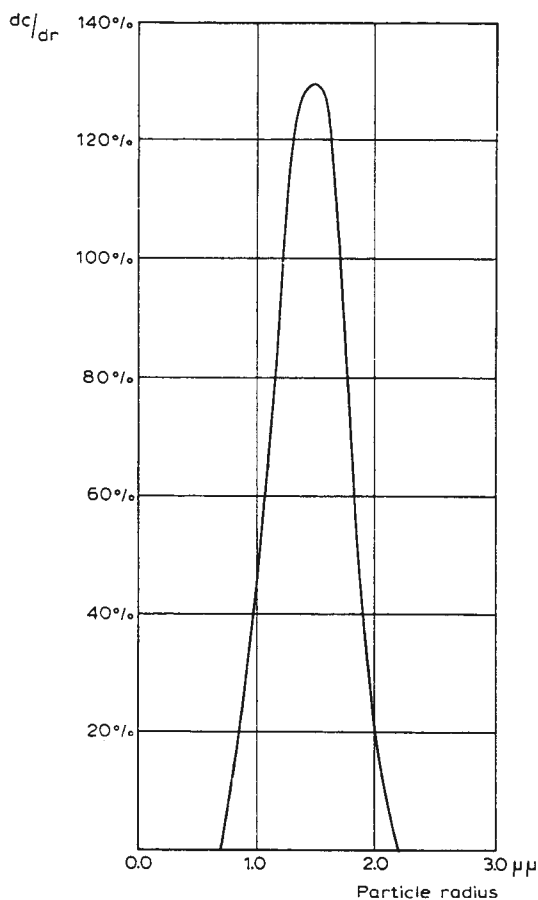

Fig. 7. The particle distribution in a highly disperse gold colloid calculated from the graph in Fig.6 (according to H. Rinde).

Another field which during the last three years has been the object of centrifugation study at the Physical Chemistry Laboratory at Uppsala, is the proteins. In this case we determined the molecular weights partly by measuring the sedimentation equilibrium and partly by measuring the sedimentation speed. By means of the centrifugation method it is possible to determine molecular weights in very dilute solutions (hundredths of one per cent). This is important since many proteins have only low solubility. It is also possible in this way to determine whether a protein solution is or is not consistent in respect of molecular size. In cases where a protein has more than one light absorption band, it is also possible to test whether these

various bands relate to the same molecular weight. Thus Nichols has shown, in connection with carefully purified haemoglobin, that the light absorption in green, blue, and long-wave ultraviolet and in short-wave ultraviolet has as its vehicle a substance having a molecular weight in the region of 68,000.

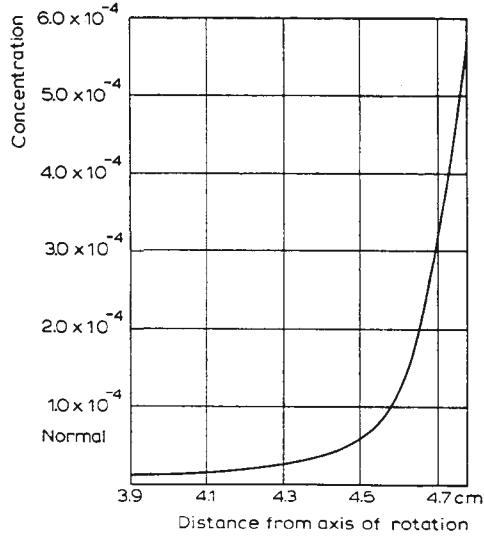

Fig. 8. Concentration distribution in a highly disperse gold colloid at sedimentation equilibrium in a field of force 350 times gravity (according to H. Rinde).

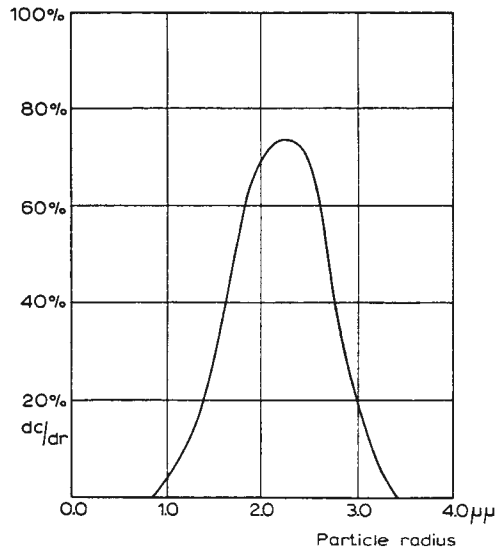

Fig. 9. The particle distribution in a highly disperse gold colloid, calculated from the graph in Fig. 8 (according to H. Rinde).

I give some data concerning the examination of haemoglobin. The study of the sedimentation equilibrium was carried out by Fåhræus and the author (1924-1925) and was continued by Nichols (1926 and 1927); a study of the sedimentation speed was carried out by Nichols and the author (1926-1927). Fig. 10 is a series of exposures of a 0.9% solution of a compound of carbon

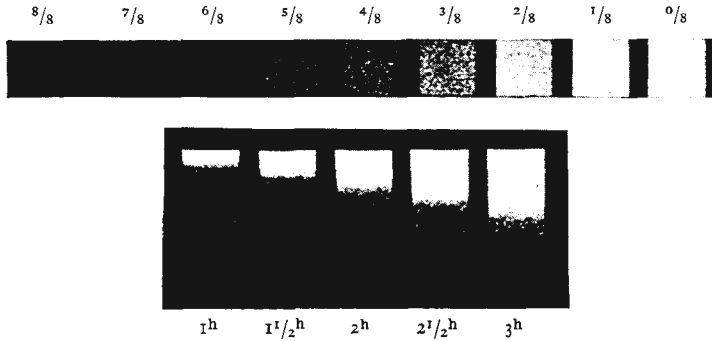

Fig. 10. Centrifugation of a solution of the compound of carbon monoxide and haemoglobin in a field of force 94,000 times gravity; time between exposures $\frac{1}{2}$ hour; concentration scale at top.

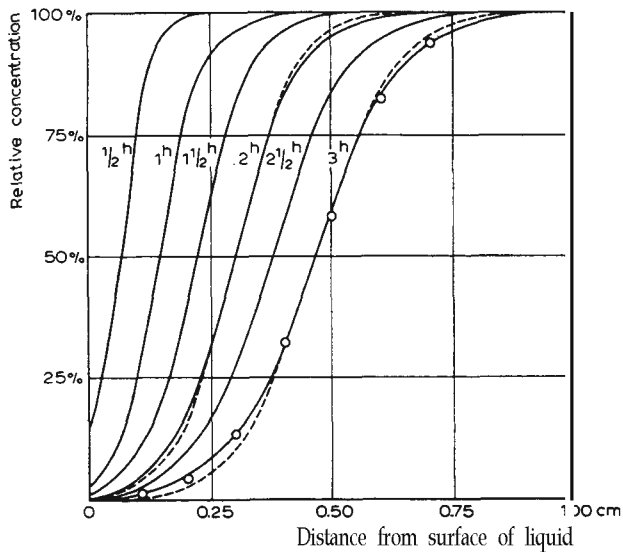

Fig. 11. The concentration distribution in a solution of the compound of carbon monoxide and haemoglobin $\frac{1}{2}$, 1, $1\frac{1}{2}$, 2, $2\frac{1}{2}$, and 3 hours after the beginning of centrifugation; field 81,000 times gravity (curves are corrected for reduction in concentration due to wedge-shape of cell and field inhomogeneity).

monoxide and haemoglobin, taken 1, 1½, 2, 2½, and 3 hours after the beginning of centrifugation. The field of force was approximately 94,000 times gravity, the temperature 30°C. Table I shows two test series for determining the molecular weight of haemoglobin. The sedimentation equilibrium gave 67,870, the sedimentation speed 68,350. Fig. 11 shows the concentration curves from the last series (after correction for reduction of the concentration as a result of the wedge-shape of the cell and the inhomogeneity of the field of force). The solid lines represent the experimental values. The broken-line curves show the concentration distribution that would be expected if all the haemoglobin molecules (or particles) were of the same size. It will be clear that the deviation is insignificant. Calculations show that at least

Table I. Haemoglobin.

Sedimentation equilibrium.

(speed = 8,708 r.p.m.; centrifugation time = 39 hours; $T = 293$;
 $w = 290.3 \pi$; $V = 0.749$)

x_2 (cm)	x_1 (cm)	c_2 (%)	c_1 (%)	M
4.61	4.56	1.220	1.061	71,300
4.56	4.51	1.061	0.930	67,670
4.51	4.46	0.930	0.832	58,330
4.46	4.41	0.832	0.732	67,220
4.41	4.36	0.732	0.639	72,950
4.36	4.31	0.639	0.564	60,990
4.31	4.26	0.564	0.496	76,570
4.26	4.21	0.496	0.437	69,420
4.21	4.16	0.437	0.308	66,400
				Mean: 67,870

Sedimentation speed.

(concentration = 0.96%; $T = 303$; $V = 0.755$; $D = 0.070$)

Interval (hours)	Δx per (½ hour)	x -med. (cm)	speed (r.p.m.)	$dx/dt: \omega^2 x$ (cm/sec)	M
0.5-1	0.074	4.525	39,300	5.36×10^{-13}	67,770
1 -1.5	0.078	4.601	39,400	5.44×10^{-13}	68,720
1.5-2	0.078	4.679	39,300	5.47×10^{-13}	69,090
2 -2.5	0.077	4.757	39,300	5.34×10^{-13}	67,450
2.5-3	0.080	4.840	39,200	5.44×10^{-13}	68,720
					Mean: 68,350

Table 2. Ovalbumin (salt-free).

*Sedimentation equilibrium.**(speed = 10,700 r.p.m.; centrifugation time = 59.5 hours; T = 288;**w = 356.6 π ; V = 0.749)*

x_2 (cm)	x_1 (cm)	c_2 (%)	c_1 (%)	<i>M</i>
4.68	4.63	1.741	1.571	33,800
4.63	4.58	1.571	1.426	32,400
4.58	4.53	1.426	1.298	31,800
4.53	4.48	1.298	1.171	35,100
4.48	4.43	1.171	1.058	35,150
4.43	4.38	1.058	0.959	34,440
4.38	4.33	0.959	0.867	35,600
4.33	4.28	0.867	0.783	36,200
4.28	4.23	0.783	0.710	35,400
				Mean: 34,400

Ovalbumin (1% NaCl).

*Sedimentation equilibrium.**(speed = 10,900 r.p.m.; centrifugation time = 41.5 hours; T = 291.5;**w = 363.37 π ; ρ = 1.0077; V = 0.741)*

x_2 (cm)	x_1 (cm)	c_2 (%)	c_1 (%)	<i>M</i>	
				<i>Found</i>	<i>Calculated for</i> 93.5% 34,000 + 6.5% 136,000
4.68	4.63	1.822	1.586	44,000	44,900
4.63	4.58	1.586	1.393	41,900	42,400
4.58	4.53	1.393	1.230	40,500	40,250
4.53	4.48	1.230	1.092	39,200	38,650
4.48	4.43	1.092	0.973	38,400	37,400
4.43	4.38	0.973	0.875	35,600	36,650
4.38	4.33	0.875	0.788	35,750	35,900
4.33	4.28	0.788	0.708	36,950	35,450
4.28	4.23	0.708	0.641	34,800	35,100
4.23	4.18	0.641	0.580	35,000	34,750

80 to 90% of the haemoglobin in question consists of molecules of a weight of 68,000. More recent measurements by Nichols have given even higher percentages for this type of molecule. It is therefore clear that the protein haemoglobin is a substantially homogeneous chemical individual. By centri-

fugation of haemoglobin in various buffer solutions Nichols was able to prove that the molecular weight is independent of the degree of acidity, at least within the range of pH 6.0-9.0.

The following albuminoids were also studied: ovalbumin (Nichols and the author), phycocyanin and phycoerythrin (Lewis and the author), haemocyanin (Chirnoaga and the author). The examination of the first three is almost complete. The result has been that all must be regarded as substantially uniform chemical individuals. Fig. 12 is a photograph of the sedimentation equilibrium in an ovalbumin solution with an operative force of 5,800 times gravity. Fig. 13 is the concentration curve. Table 2 gives two test series with ovalbumin, one for a uniform material, and the other for a material containing a component of high molecular weight. Fig. 14 finally shows a centrifugation series with phycoerythrin. The field of force was 90,000 times gravity, the temperature 30°C and the time between exposures 20 minutes.

Table 3.

<i>Substance</i>	<i>Molecular weight</i>	<i>Method</i>	<i>Observer</i>
Ovalbumin (electrolyte-free)	34,500	equilibrium	Nichols and author 1926
Haemoglobin (electrolyte-free)	67,700	equilibrium	Fåhræus and author 1925
Haemoglobin (electrolyte-free)	68,000	speed	Author 1926
Haemoglobin (buffer pH 6.2-7.7)	68,100	speed	Nichols 1927
Phycocyanin (buffer pH 7.0-7.9)	105,900	equilibrium	Lewis and author 1927
Phycocyanin (buffer pH 7.0)	105,000	speed	Lewis and author 1927
Phycoerythrin (buffer pH 5.0-6.8)	207,700	equilibrium	Lewis and author 1927
Phycoerythrin (buffer pH 5.0-6.8)	226,800*	speed	Lewis and author 1927

* Owing to the difficulty of measuring the speed of diffusion of the phycoerythrin exactly, this value is less accurate than the preceding value.

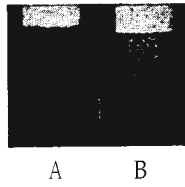

Fig. 12. Centrifugation of an ovalbumin solution: (A) at beginning of centrifugation; (B) after reaching sedimentation equilibrium; field of force 5,800 times gravity (according to J. B. Nichols).

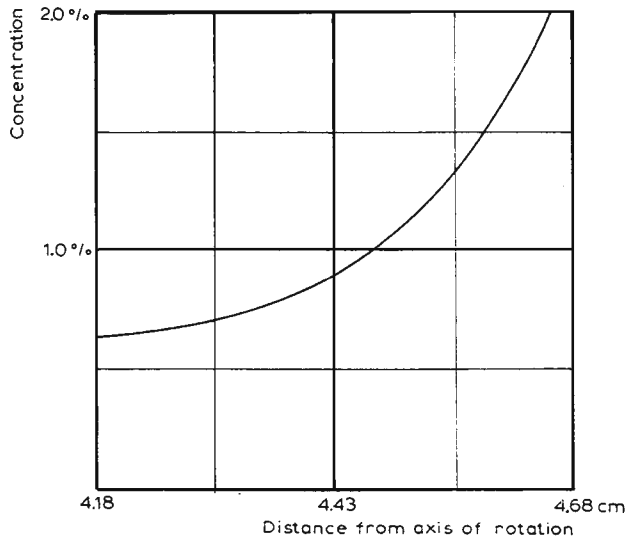

Fig. 13. The concentration distribution in an ovalbumin solution at sedimentation equilibrium in a field of force 5,800 times gravity (according to J. B. Nichols).

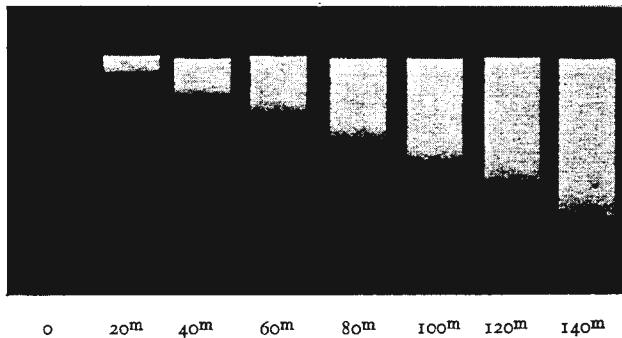

Fig. 14. Centrifugation of a phycoerythrin solution in a field of force 90,000 times gravity; time between exposures 20 minutes (according to N. B. Lewis).

Table 3 gives the molecular weights of the proteins hitherto studied by the centrifugation method. The values obtained by sedimentation equilibrium and sedimentation speed correspond to one another within the test error limits. It is interesting to note how the molecular weight of phycoerythrin is approximately twice the molecular weight of phycocyanin. These two proteins occur together in red algae (the material studied originates from a Swedish species of the genus *Ceramium*. According to analyses by Kylin (1910) and Kitasato (1925), their elementary composition is identical within the analysis error limits. According to the centrifugation examination carried out by Lewis, it is therefore probable that the main difference between them is that phycoerythrin has twice the molecular weight of phycocyanin. Phycoerythrin is red (strong absorption band in green), while phycocyanin is blue (strong absorption band in yellow). Since these two proteins are relatively difficultly soluble and they also contain no metallic constituents, it was impossible to determine or estimate their molecular weight in any way other than by centrifugation.

Examination of highly disperse colloids and other solutions of similar properties by centrifugation is still at its very beginning. The results obtained clearly show that in this way it will be possible gradually to collect a valuable fund of knowledge concerning such medicinally and technically important groups as the proteins, polymeric hydrocarbons (for example rubber), polymeric carbohydrates (for example starch, cellulose), etc.