

ELECTRON SPECTROSCOPY FOR ATOMS, MOLECULES AND CONDENSED MATTER

Nobel lecture, 8 December, 1981

by

KAI SIEGBAHN

Institute of Physics, University of Uppsala, Sweden

In my thesis [1], which was presented in 1944, I described some work which I had done to study β decay and internal conversion in radioactive decay by means of two different principles. One of these was based on the semi-circular focusing of electrons in a homogeneous magnetic field, while the other used a big magnetic lens. The first principle could give good resolution but low intensity, and the other just the reverse. I was then looking for a possibility of combining the two good properties into one instrument. The idea was to shape the previously homogeneous magnetic field in such a way that focusing should occur in two directions, instead of only one as in the semi-circular case. It was known that in betatrons the electrons performed oscillatory motions both in the radial and in the axial directions. By putting the angles of period equal for the two oscillations Nils Svartholm and I [2, 3] found a simple condition for the magnetic field form required to give a real electron optical image i.e. we established the two-directional or double focusing principle. It turned out that the field should decrease radially as $\frac{1}{\sqrt{R}}$ and that double focusing should occur

after π . $\sqrt{2} \sim 255^\circ$. A simple mushroom magnet was designed, the circular pole tips of which were machined and measured to fit the focusing condition. ThB was deposited on a wire net and put into position in the pole gap. A photographic plate was located at the appropriate angle and the magnet current set to focus the strong F line of ThB on the plate. Already the first experiment gave a most satisfactory result. Both the horizontal and the vertical meshes of the wire net were sharply imaged on the plate. A more detailed theory for the new focusing principle was worked out and a large instrument with $R = 50$ cm was planned and constructed [4]. Due to the radially decreasing field form an additional factor of two was gained in the dispersion, compared to the homogeneous field form. Since all electrons, for reasonably small solid angles, were returning to the symmetry plane of the field at the point of focus no loss in intensity was experienced by increasing the radius of curvature of the instrument. Very large dispersion instruments with good intensity and much improved resolving power could therefore be designed to record β spectra and internal conversion spectra from radioactive sources. The magnetic double focusing was convenient for the fairly high energy electrons (50 keV-2 MeV)

normally occurring in radioactive decay and the field form could easily be achieved by means of shaping the poles of an iron magnet. In my laboratory and in many other nuclear physics laboratories double focusing spectrometers frequently became used for high resolution work [5]. This type of focusing was also used subsequently by R. Hofstadter [6] in his well-known work on high energy electron scattering from nuclei and nucleons.

During the late forties, the fifties and the early sixties I was much involved in nuclear spectroscopy. This was a particularly interesting and rewarding time in nuclear physics since the nuclear shell model, complemented with the collective properties, was then developed, which to a large extent was founded on experimental material brought together from nuclear decay studies. Nuclear disintegration schemes were thoroughly investigated, and the spins and parities of the various levels were determined, as well as the intensities and multipole characters of the transitions. During this period the discovery of the non-conservation of parity added to the general interest of the field. Also the form of the interaction in β decay, appearing originally in Fermi's theory, was extensively investigated. A large part of my own and my students' research was therefore concerned with nuclear spectroscopy of radioactive decay [7-23]. In 1955 I edited a volume [24] on "Beta and Gamma Ray Spectroscopy". In 1965 I concluded my own career as a nuclear spectroscopist by publishing [25] "Alpha, Beta and Gamma Ray Spectroscopy". In this extensive survey of nuclear spectroscopy I had been able to collect the prodigious number of 77 coauthors, all being prominent authorities and in many cases the pioneers in the various fields. Although my own scientific activity at that time had almost entirely become directed towards the new field which is the subject of the present article I have still kept my old interest in nuclear physics much alive as the editor for the journal *Nuclear Instruments and Methods in Physics Research* (NIM) ever since its start in 1957.

Let me now return to the situation around 1950. At that time my coworkers and I had already for some time been exploring the high resolution field by means of our large dispersion double focusing instrument and other methods, such as the high transmission magnetic lens spectrometer and coincidence techniques. Often I found, however, that my experimental work had to stop and wait for radioactive samples, the reason being a capricious cyclotron. It then came to my mind that I should try to simulate the radioactive radiation by a substitute which I could master better than the cyclotron. I had found that a very convenient way to accurately investigate gamma radiation from radioactive sources was to cover them with a γ -ray electron converter, i.e. a thin lead foil which produced photoelectrons to be recorded in the spectrometer. I now got the idea that I should instead use an X-ray tube to expel photoelectrons from ordinary materials, in order to measure their binding energies to the highest possible accuracy. In my nuclear physics work such binding energies had to be added to the energy values of the internal conversion lines from the radioactive sources in order to get the energies of the nuclear transitions. I studied what had been done along these directions before [26, 27], and I finally got a vague feeling that I could possibly make an interesting and perhaps big

step forward in this field if I applied the experience I had from nuclear spectroscopy using the above mentioned external photoeffect and my high resolution instruments. The previous investigations had confirmed that the atomic electrons were grouped in shells, and by measuring on the photographic plates the high energy sides of the extended veils from the various electron distributions approximate values of the binding energies could be deduced. On the other hand, since the observed electron distributions had no line structure and consequently did not correspond to atomic properties, the attained precision and the actual information was far inferior to what could be obtained by X-ray emission and absorption spectroscopy. I realized that electron spectroscopy for atoms and solids could never become competitive with X-ray emission or absorption spectroscopy unless I was able to achieve such a high resolution that really well-defined electron lines were obtained with linewidths equal to or close to the inherent atomic levels themselves.

I thought of these problems considerably and started to make plans for a new equipment which should fulfill the highest demands on resolution at the low electron energies I had to be concerned with, ten to a hundred times smaller than in radioactive work. I recall I sat down for some days early in 1950 to try to make a thorough calculation about the expected intensities. I designed [28, 29, 30] an ironfree double focusing spectrometer with $R = 30$ cm, in which I should be able to measure the current with a precision of better than 1 part in 10^4 . The spectrometer was surrounded by a big, three-component Helmholtz coil system to eliminate, to better than 1 part in 10^3 , the earth's magnetic field over the entire region of the spectrometer. If I had an X-ray tube with a Ka radiation in the region of 5 keV, this would enable me to measure expelled photoelectrons with a precision of a fraction of an electron volt. This I thought was about sufficient in atomic physics. I also hoped to observe phenomena of chemical interest provided I could realize the resolution I aimed at, but at that time my ideas in this latter respect were of course very vague, centering around atomic level shifts in alloys, etc. When I calculated the expected intensities of the photoelectron lines, I started from the very beginning, i.e. with a certain number of mA's in the X-ray tube, I then calculated by means of existing knowledge the number of Ka X-ray photons, next I put in all solid angles both in the X-ray tube and the electron spectrometer and made some assumptions about the effective photoelectron cross sections to expel electrons from the outermost layers in a solid surface. Those electrons could not be expected to suffer much energy loss and were the interesting ones upon which I should base my spectroscopy. In retrospect, this last stage in my considerations was of course of some interest, in view of the later development of electron spectroscopy into a *surface* spectroscopy. I guessed that what is now called the "escape depth" of the electrons should be less than a light wavelength and more than a few atomic layers and so I used 100 \AA in my calculations. This was not too bad a guess in consideration of later studies, indicating a lower figure for metals and 100 \AA for organic multilayers. I finally arrived at an estimated counting rate on a photoline in my apparatus of several thousands of electrons per minute as recorded in the Geiger-Müller (G-M) counter placed at the focal plane in the

double focusing spectrometer. Afterwards I was satisfied to find that this calculation turned out to correspond fairly well to reality. This step, however, in fact took several years to make.

The equipment which I had to build and test was at that time very complicated. The resolution ultimately achieved turned out to be high enough to enable recording even of the inherent widths of internal conversion lines [24]. This was done in 1954 and in 1956 I published [31] together with my collaborator, Kay Edvarson, an account of this phase of the work under the title " β -ray Spectroscopy in the Precision Range of $1:10^5$ ". In the next phase I had, however, to overcome many difficulties in handling the low energy electrons excited by X-rays and to record them by the G-M counter. This had an extremely thin window through which gas diffused continuously and so was compensated for by an automatic gas inlet arrangement. I did not realize, to start with, the precautions I had to take when dealing with surfaces of solids in order to record resolved line structures.

After some further testing of the equipment, concerning the influence of the finite nuclear size on the conversion lines in some nuclei [32, 33], my two new coworkers, Carl Nordling and Evelyn Sokolowski, and I finally made the transition to atomic physics and were able to record our first photoelectron spectrum [34, 35] with extremely sharp lines and with the expected intensities. These electron lines definitely had all the qualities which I had set as my first goal. They were symmetric, well defined and had linewidths which could be deduced from the linewidth of the X-ray line used and the width of the atomic level of the element under study, plus of course a small additional broadening due to the resolution of the instrument. Fig. 1 shows an early recording of MgO. The exact position of the peak of the electron lines could be measured

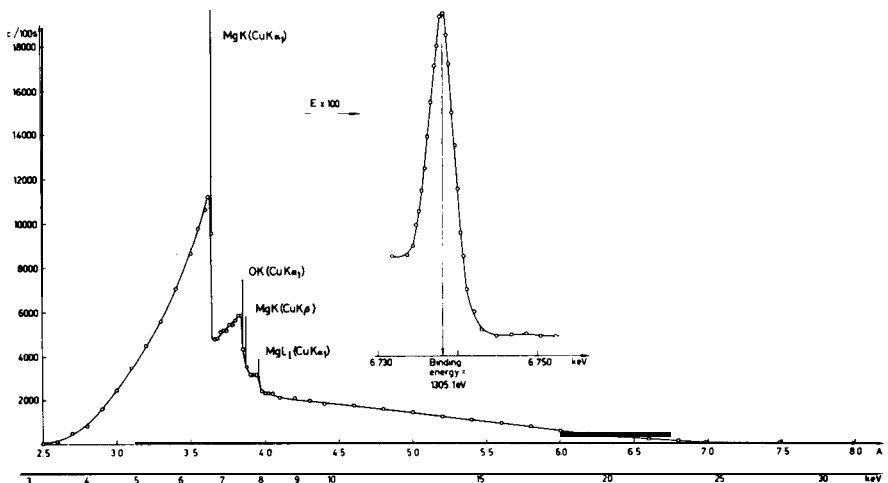

Fig.1. Electron spectrum obtained from magnesium oxide with copper X-radiation. Edges are found at energies corresponding to atomic levels of magnesium and oxygen. A very sharp electron line can be resolved from each edge. Such an electron line is shown in the insert figure with the energy scale expanded by a factor of one hundred to bring out the finite width of the line.

with considerable accuracy. Electron spectroscopy for atoms could be developed further with confidence.

Fig. 2 illustrates the steps which we took from the earlier recording of the photoelectrons expelled from a gold foil by Robinson [36] in 1925 to the introduction of the electron line spectroscopy in 1957. The dotted line inserted in Robinson's spectrum should correspond to the place where our spin doublet $N_{vi}N_{vii}$ to the right in the figure is situated. The distance between the two well resolved lines in our spectrum would correspond to about 0.1 mm in the scale of Robinson's spectrum. Below this spectrum the black portion has been enlarged (the gray scale) to show the corresponding part in our spectrum. This spectrum was taken at a later stage of our development. Within this enlarged spectrum a further enlargement of the $N_{vi}N_{vii}$ doublet is inserted. The spin-orbit doublet has now a distance between the lines which corresponds to a magnification of 600 times the scale in Robinson's photographic recording.

A comparison between the middle and the lower spectrum in the figure further demonstrates the extreme surface sensitivity of electron spectroscopy. The difference between the two spectra is caused by a slight touch of a finger. At the beginning this sensitivity caused us much trouble, but later on, when electron spectroscopy was applied as a surface spectroscopy, it turned out to be one of its most important assets.

In 1957 we published some papers [34, 35, 37] describing our first results, which really did indicate great potential for the future. We also obtained our first evidences of chemical shifts [37-42] for a metal and its oxides and for Auger electron lines. I thought, however, that we should first improve our techniques and explore purely atomic problems until we had achieved a greater knowledge to enable us to progress to molecular problems. We therefore systematically measured atomic binding energies for a great number of elements with much improved accuracy compared to previous methods, in particular X-ray absorption spectroscopy [40, 41, 43-61]. We were surprised to find how inaccurate previously accepted electron binding energies for various shells and elements could be. We made so-called "modified" Moseley diagrams. We were bothered by uncertainties due to the chemical state and therefore tried to use only metals or at least similar compounds of the elements in our systematic studies. We also devoted much effort to the investigation of the Auger electron lines [62-69] which appeared in our spectra with the same improved resolution as our photoelectron lines. As one of the results of such studies we were able to observe for a group of elements around $Z = 40$ all the nine lines expected in the intermediate coupling theory as compared to the observed six lines in pure $j-j$ coupling [63]. In general, in the spectroscopy we developed photoelectron and Auger electron lines were found side by side. Later on, therefore, we avoided any notation for this spectroscopy which could give the false impression that only one of the two types of electron lines were present. Auger electron lines can *in addition* to the X-ray mode of excitation also be produced by electrons. Much of the above basic work on atomic energy levels is described in theses by E. Sokolowski [70], C. Nordling [71], P. Bergvall [72], O. Hörnfeldt [73], S. Hagström [74] and A. Fahlman [75].

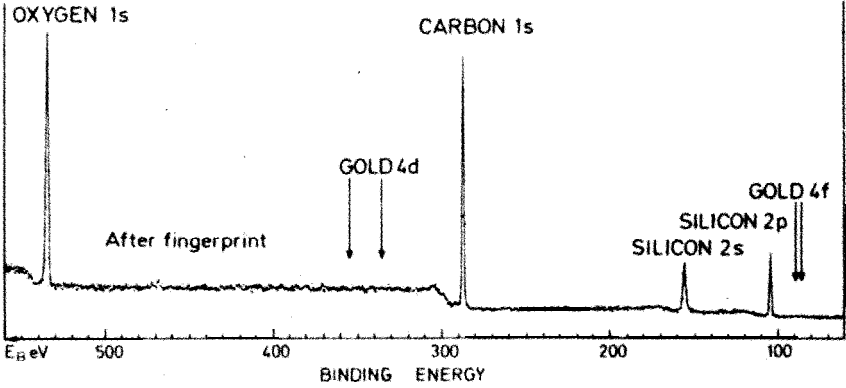
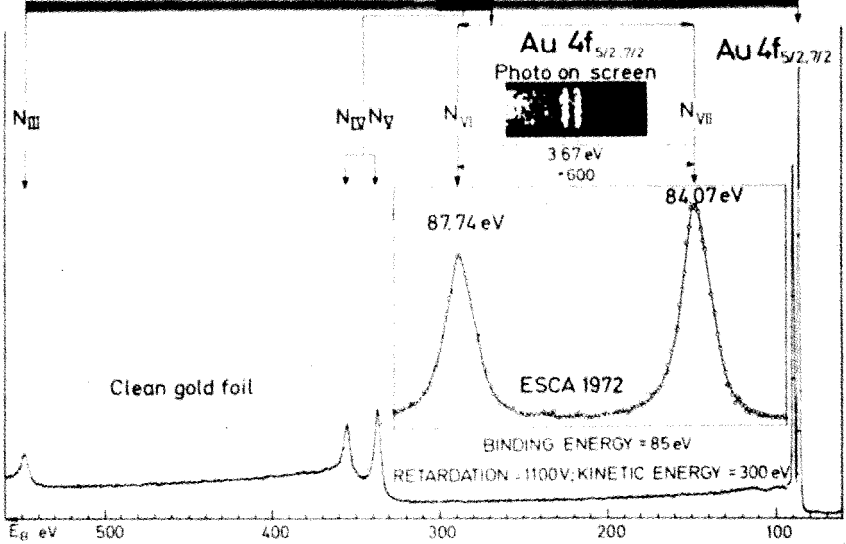
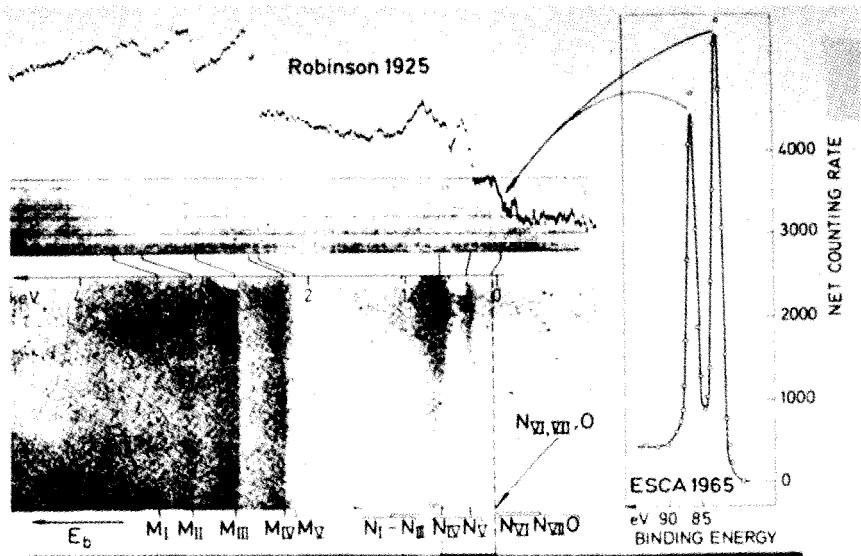

After some years' work in electron spectroscopy on problems in atomic physics the next step came to the fore, namely to make systematic studies of the chemical binding. This step was taken together with my coworkers Stig Hag-Strom and Carl Nordling when $\text{Na}_2\text{S}_2\text{O}_3$ was found to give two well resolved K photoelectron lines from the sulphur [76]. This showed that two differently bonded sulphur atoms could be separated in the molecule, which according to classical chemistry were in the -2 and the +6 valence states, respectively. This was a more clear-cut case than the copper-copperoxide case we had studied before, since the reference level for the two sulphur atoms could be traced to the same molecule. The systematic investigation of chemical binding by means of electron spectroscopy is described in theses by S.-E. Karlsson [77], R. Nordberg [78], K. Hamrin [79], J. Hedman [80], G. Johansson [81], U. Gelius [82] and B. Lindberg [83].

Fig. 3 shows the chemically shifted Cls spectrum of ethyl trifluoroacetate [84, 85]. Fig. 4 [86] shows how the chemical shift effect can be used to identify groups linked together in branched chains in polymers [87-90]. The intensities of the lines are correlated to the different branchings in the two viton polymers.

In the interpretation of the electron spectra the first step is to consider the electron structure as 'frozen' under the photoelectron emission process. In this approximation the measured electron binding energies can be identified with the Hartree-Fock energy eigenvalues of the orbitals. One then disregards the fact that the remaining electronic structure, after electron emission, is relaxing to a new hole state. This relaxation energy is by no means negligible and an accurate calculation of the relevant binding energies has to include both the ground state and the hole state energies as the difference between them. The inclusion of relativistic effects in this treatment is essential for inner core ionization and heavier elements (I. Lindgren [91]). More recently, methods have been devised to describe the photoelectron emission by means of a transition operator which properly accounts for the relaxation process [92-94]. Various conceptual models complement the computational procedures on an ab initio level.

For chemical shifts in free molecules, it is usually sufficiently accurate to consider only the ground state properties [95-106]. This is due to the circum-

Fig.2. Electron spectra of gold.

Upper left: Spectrum recorded by Robinson in 1925 /36/. (Reproduced by due permission from Taylor & Francis Ltd, London.)

Upper right: ESCA spectrum recorded in Uppsala before 1965 by non-monochromatized $\text{MgK}\alpha$ excitation. The N_{vi} , N_{vii} levels are seen as two completely resolved lines in this spectrum whereas the N_{vi} , N_{vii} and O levels appear together as a hump in the photometric recording by Robinson and are only barely visible on the photographic plate.

Middle: ESCA spectrum recorded in Uppsala 1972 by monochromatized $\text{AlK}\alpha$ excitation. The magnification of this spectrum is 600 times that of Robinson.

Lower Part: ESCA spectrum of a gold foil with a fingerprint on the surface. The electron lines are entirely due to the fingerprint whereas the gold lines are missing.

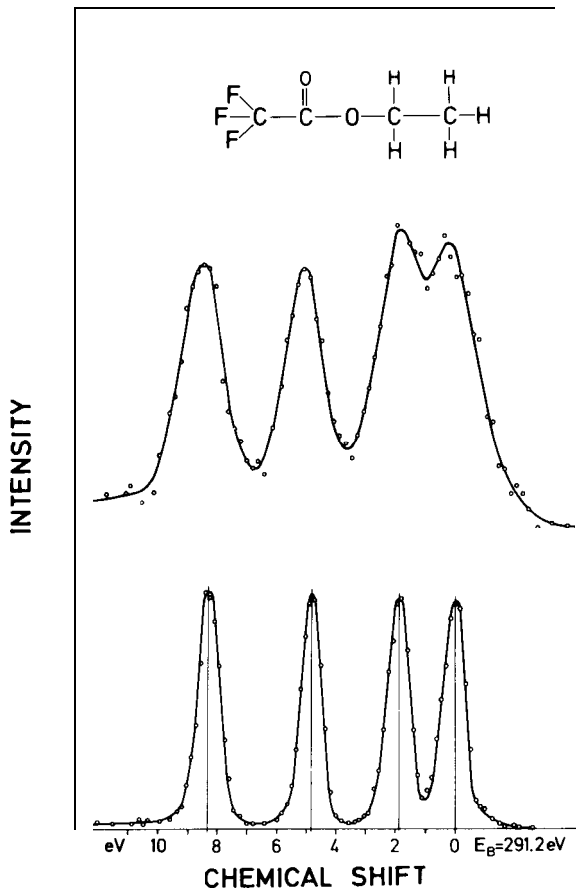

Fig.3. The ESCA shifts of the Cls in ethyl trifluoroacetate. Upper spectrum without and lower with X-ray monochromatization (184, 85).

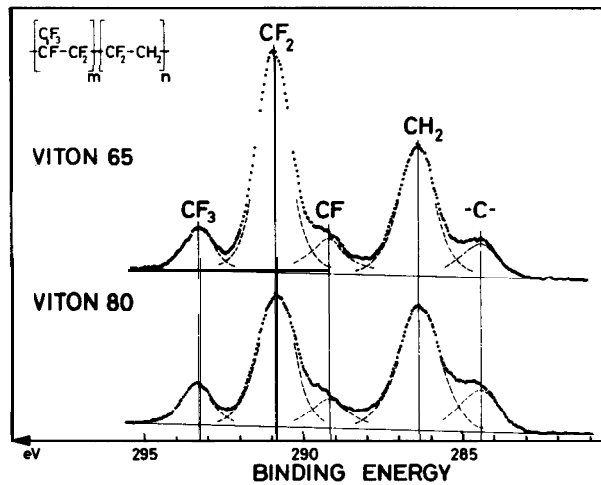

Fig.4. ESCA spectra of Viton 65 and Viton 80 polymers.

stance that relaxation energies for a series of similar electronic systems vary only marginally. This can be described by the division of the relaxation energy into two contributions, one connected to the atomic contraction at ionization, the other to the 'flow' of charge from the rest of the molecule [107, 108]. The atomic part, which is very nearly constant for one specific element, is the dominating contribution to the relaxation energy. The 'flow' part varies generally marginally for free molecules of similar structure, leading to constant relaxation energies. There are cases, however, where the 'flow' part can significantly change from one situation to another. One example is when a molecule is adsorbed on a metal surface. In such a situation the flow of conduction electrons from the metal substrate will contribute to the relaxation of the core hole. This can increase the relaxation energy by several eV [109, 110]. Other cases are pure metals and alloys where the conduction electrons are responsible for the screening of the hole. [111 - 116]. These are treated in these work by N. Mårtensson [117] and R. Nyholm [118].

In view of the interesting applications which the chemical shift effect offered for chemistry and the fact that at that time we had found that electron spectroscopy was applicable for the analysis of all elements in the Periodic System, we coined the acronym ESCA, Electron Spectroscopy for Chemical Analysis. If one is particularly interested in conduction bands for metals or alloys (Fig. 5

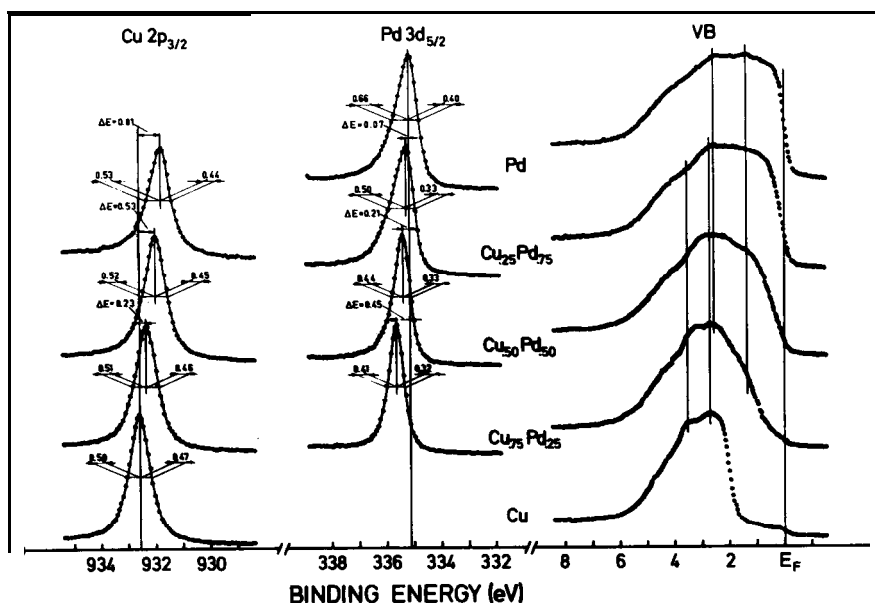

Fig. 5. Core and valence electron spectra (excited by monochromatized $\text{AlK}\alpha$ -radiation) of some $\text{Cu}_x\text{Pd}_{1-x}$ alloys, including the pure constituents. The binding energies undergo positive chemical shifts with increasing Cu-content. The asymmetries of the lines are due to creation of soft electron-hole pairs at the Fermi edge upon core ionization. The magnitude of the asymmetry is thus related to the (local) density of states at the Fermi level. The Pd lines are seen to become more symmetric as the Cu content increases (Pd local density of states decreases).

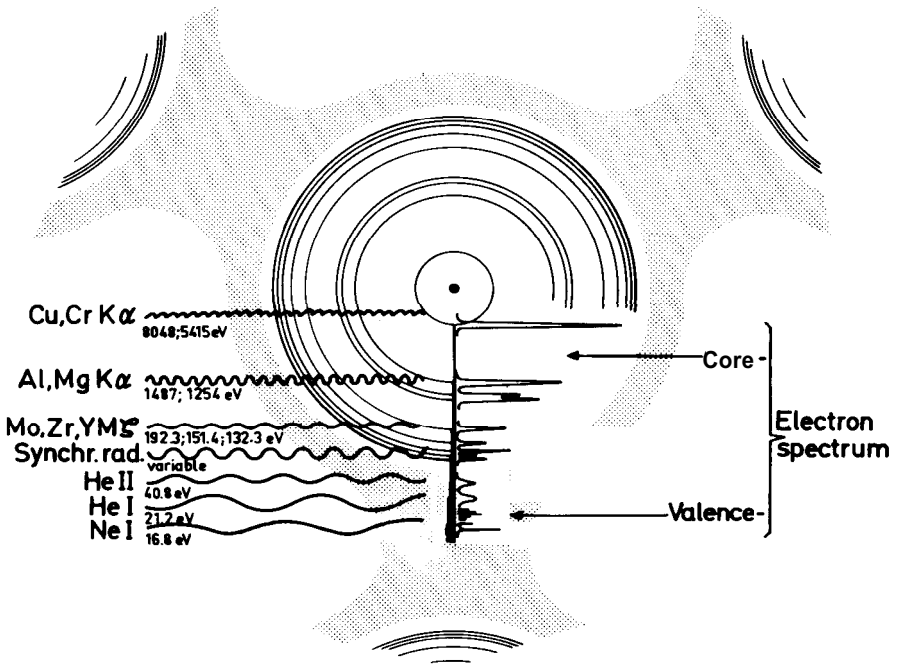

Fig. 6. Regions of binding energies accessible with different photon sources

Solid circles: localized, atom-like orbitals.

Shaded area: more or less delocalized, molecular orbitals.

[119]) or valence electron structures of solid material in general, or free molecules, more detailed notations can be preferred. One useful distinction is between core and valence electron spectra (Fig. 6). Obviously, a further ground of classification is due to the different origin of the photoelectron and Auger electron lines, which both always occur in ESCA, as mentioned before. The corresponding chemical shift effect for the Auger electron lines we established soon afterwards [69] in the case of $\text{Na}_2\text{S}_2\text{O}_3$. Further studies [111, 112, 120-133] have shown that the two shift effects are complementary. The combination of the two shifts provides insight into the mechanism of relaxation in the photoionization process. Auger electron spectra are given in Fig. 7 for a clean Mg metal, and when it is partly and finally fully oxidized to MgO [86].

Apart from the ordinary core electron lines and the Auger electron lines from the various shells, all characteristic of each element, the electron spectra also contain additional features. Satellites situated close to (~ 10 eV) the main core lines at the low energy sides are often observed with intensities around 10% of the latter. Fig. 8 [114] shows the electron spectrum of gaseous Hg. Inserted are the satellites to the $\text{N}_{\text{vi}}\text{N}_{\text{vii}}$ lines. Strong satellites were first observed [68] in our spectra in the KLL Auger electron spectrum of potassium in some compounds. Satellites have been found to occur frequently for core lines and occasionally they can even have intensities comparable to the main lines, e.g. paranitroaniline [134-136], transition metal compounds [137-146] and var-

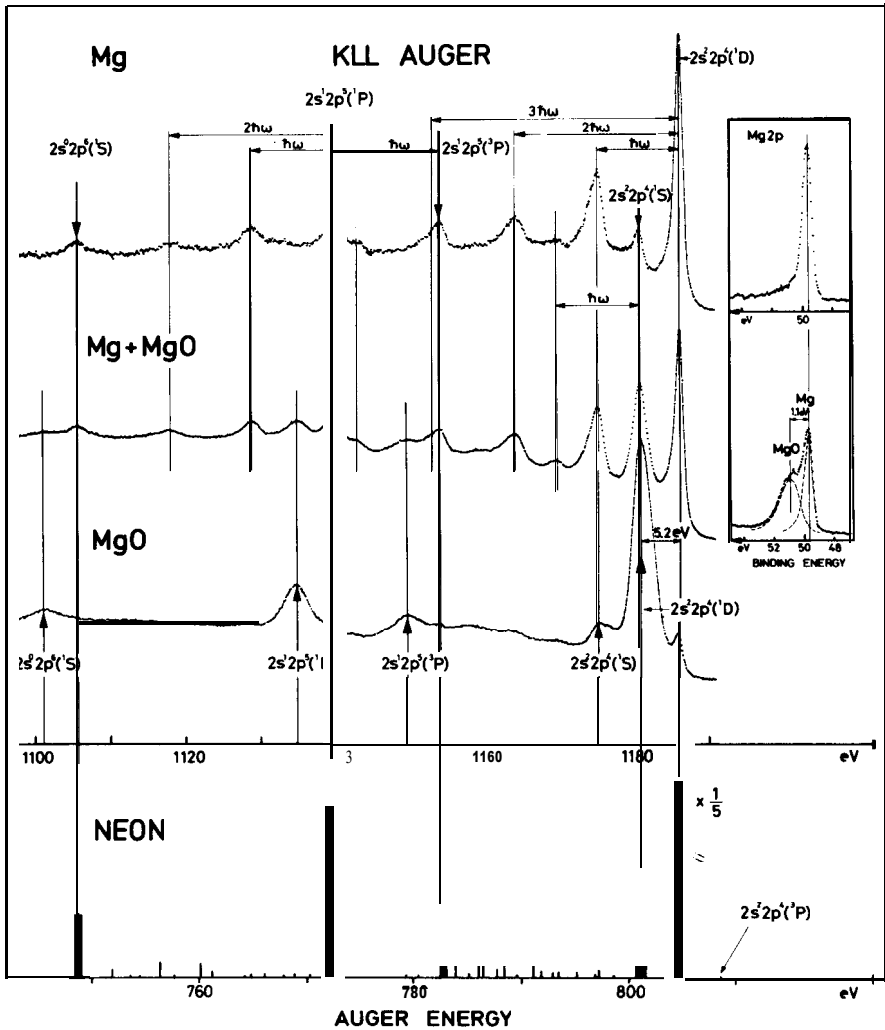

Fig. 7. MgKLL Auger electron spectra at different stages of oxidation as obtained in ESCA. Upper spectrum is from a clean metal surface, lower spectrum from the oxidized metal (with only a trace of metal) and the middle spectrum is from an intermediate oxidation. Volume plasmon lines are observed. For comparison, the positions of the NeKLL Auger electron lines are given below, as recorded in the ESCA instrument by means of electron beam excitation.

ious adsorbed molecules on surfaces [148, 149]. Since these electrons can be visualized as being emitted from excited states, the satellites were given the name "shake-up" lines.

Molecules like O_2 or NO contain unpaired electrons and are therefore paramagnetic. Large classes of solid materials have similar properties. In such cases core electron spectra show typical features called spin-, multiplet-, or exchange splitting. We first observed this phenomenon [150] in oxygen when

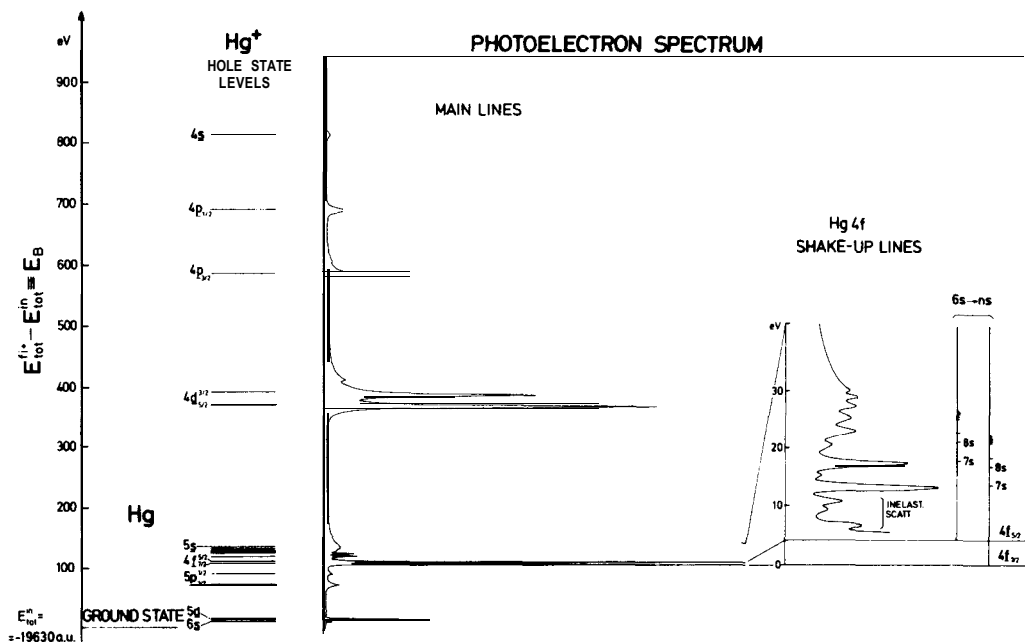

Fig. 8. Relation between the hole-state level system and observed photoelectron spectrum for the mercury atom. The figure illustrates that the main lines are connected with states of the ion where (in a one-electron picture) an atomic orbital has been removed from the neutral ground state. The energy region close to the $4f$ -lines has been expanded (far right) to show that the additional satellite lines observed (shake-up lines) are due to excitations ($6s \rightarrow ns$) above the $4f$ hole ground states. (Note that the intensities of the $4f$ -lines have been truncated to fall into the scale of the figure.) (From refs. 114 and 260.)

air was introduced into the gas cell in our ESCA instrument (Fig. 9). The $1s$ line of O_2 is split in the intensity ratio of 2:1. This spin splitting is due to the exchange interaction between the remaining $1s$ electron and the two unpaired electrons in the $\pi_g 2p$ orbital, which are responsible for the paramagnetism of this gas. The resulting spin can be either $1/2$ or $3/2$. The corresponding electrostatic exchange energies can be calculated and correspond well with the measured splitting of 1.11 eV [151]. Apart from oxygen and nitrogen, argon and CO_2 can also be seen in air in spite of the low abundances of these gases. A statistical treatment of the data even exhibits the presence of neon (0.001%).

Other particular features in the spectra occur in the valence electron region, i.e. at binding energies extending from zero binding energy to say 50 eV. Our first study of this entire region concerned ionic crystals like the alkali halides [152].

In a later study [153] (1970) of a single crystal of NaCl we discovered the phenomenon of ESCA diffraction. We investigated the angular distribution of emitted Auger electrons from the NaKLL (D_p) transition and the photoelec-

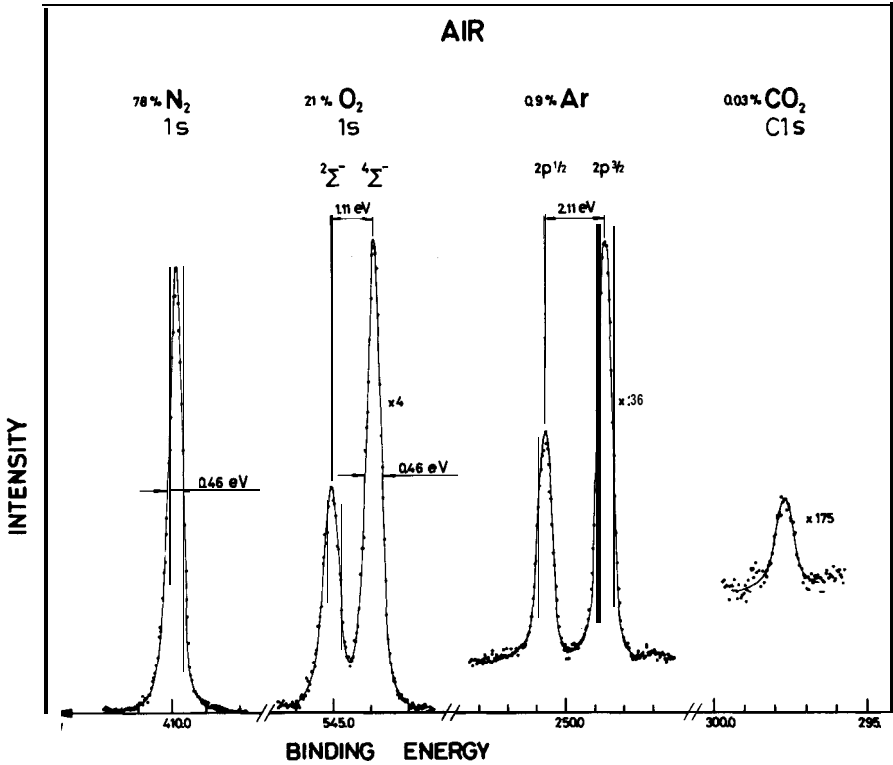

Fig. 9. Electron spectrum of air. The O_{1s} is split into two components due to 'spin' or 'multiplet' splitting. Excitation was performed by means of monochromatized $AlK\alpha$ ($h\nu = 0.2eV$) radiation.

trons from the N_{1s} , Na_{2s} , $C_{1s}p_{3/2}$ and the $C_{1s}p$ levels, the latter being the outermost valence orbital of the crystal. For excitation both $AlK\alpha$ and $MgK\alpha$ were used. The crystal could from outside be set at different angular positions relative to the emission direction of the electrons, which in turn was defined by the slit system of the ESCA instrument. For comparison, the angular distributions from polycrystalline samples were also recorded. In all cases typical diffraction patterns were found. In the control experiments on the polycrystalline samples there were no such patterns. Fig.10 shows two of the diffraction patterns recorded. Subsequent measurements [154-158] on other single crystals have shown agreement with the above investigation.

ESCA diffraction has more recently been applied to surface studies giving interesting information on the geometry of adsorbed molecules [159-161] on single crystals. This field is under development and should have a promising future in surface science.

In X-ray diffraction there is an incoming photon wave and an outgoing diffracted photon wave. In electron diffraction there is an incoming electron wave and an outgoing diffracted electron wave. In ESCA diffraction there is an

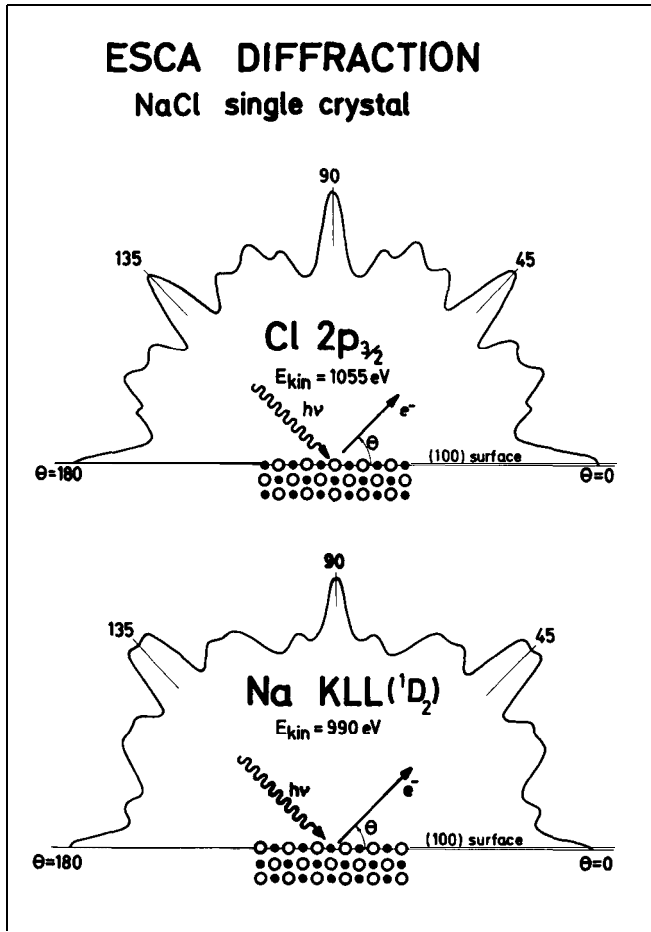

Fig. 10. Angular distributions of $\text{Cl}2p_{3/2}$ photoelectrons ($\text{MgK}\alpha$) and $\text{NaKLL} ('D_2)$ Auger electrons from a NaCl single crystal.

incoming photon wave and an outgoing diffracted electron wave with different energies. These are three distinctly different physical phenomena which obviously require both different experimental equipment to observe and different theoretical treatments to evaluate. With more suitably built instruments for this purpose and with the addition of stronger X-ray sources and synchrotron radiation [161-164] the development can proceed further.

In order to study gases and vapours from liquids, we first introduced a freezing technique [165] to condense the gases onto the specimen plate. In this way we obtained the valence or molecular orbital spectrum of solidified benzene [166]. Soon afterwards we found that we could study the gaseous phase just as well by introducing differential pumping in the instrument. Acetone was our first study with this technique for gases, i.e. for free molecules, revealing two well separated Cls core lines, one for the ketocarbon and one for the methyl carbon in the intensity ratio of 1:2 [167].

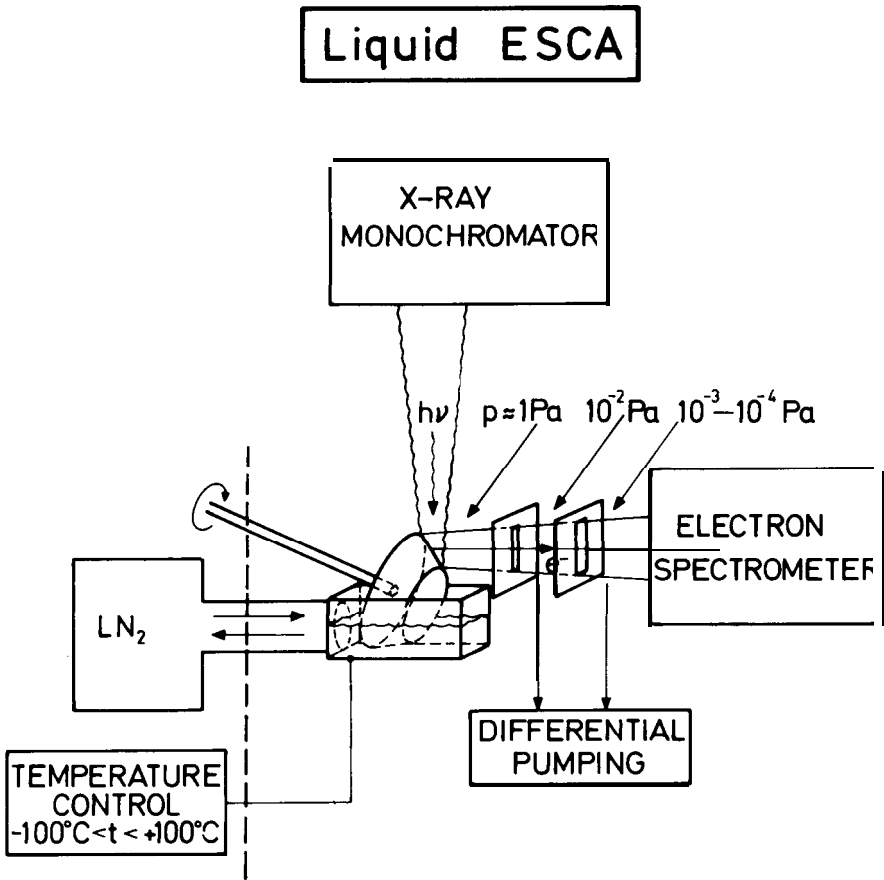

Fig. 11. Schematic diagram of the liquid-sample arrangement

Since solids, surfaces, gases and vapours from liquids were all found to be suitable samples in electron spectroscopy the question arose whether also liquids could be studied. This turned out to be quite possible and several satisfactory methods have been developed in our laboratory [168-173]. The early methods and applications are described in theses by H. Siegbahn [174], L. Asplund [175] and P. Kelfve [176]. Recently a new, more convenient arrangement (H. Siegbahn) has been developed which is shown in Fig. 11 [173]. A small trundle is rotating in the sample cell in which the liquid is introduced. A slit transmits the exciting radiation, e.g. X-radiation and the expelled electrons from the continuously wetted trundle can leave the house through a slit where differential pumping reduces the gas pressure. Cooling of the sample has been introduced which has enabled a vast increase of the number of liquids that can be studied. Fig. 12 shows part of a recent [173] spectrum of ethanol as a solvent in which iodine and sodium iodide are dissolved. One observes here a well resolved spin-orbit doublet of iodine $3d_{5/2}$

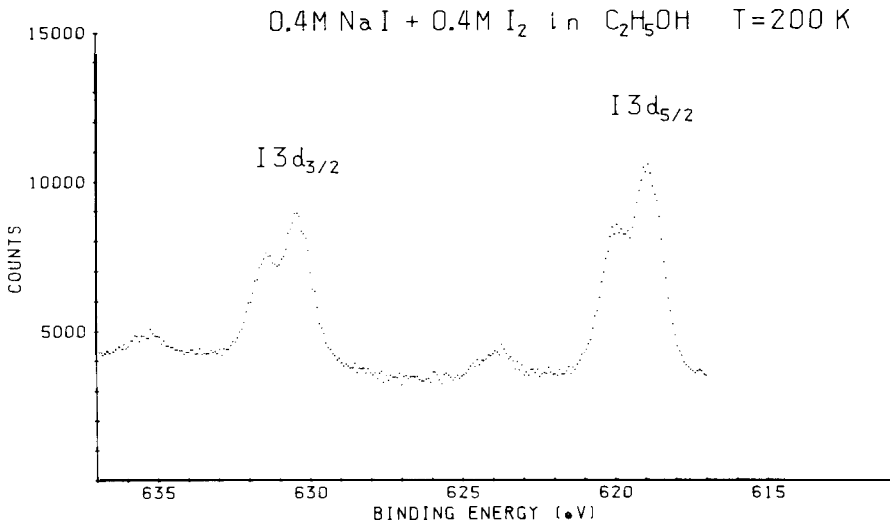

Fig. 12. I3d spectrum from a solution of NaI (0.4M)+I₂(0.4M)in ethanol obtained at T = 200K. The doublet for each spin-orbit component is due to ionization of the central atom (lower peak) and outer atoms (higher peak) of the I₃ ion. The extra peaks at the high-binding-energy sides of each spin-orbit component are interpreted as shake-up structures.

and 3d_{5/2}. Each of these electron lines is chemically split in the ratio of ~1:2. The interpretation is that I₃ has been formed in the solution. The centrally located iodine has the highest binding energy. The correct intensity ratio of 1:2 is obtained when the shake-up satellites are ascribed to the two externally situated iodine atoms, a conclusion which is in agreement with what we have found for similar configurations in other electron spectra. Liquid ethanol itself is shown in Fig. 13. Here one observes the oxygen 1s core line, the chemically split carbon 1s line and the valence electron spectrum. The field of liquids is presently in a state of rapid development.

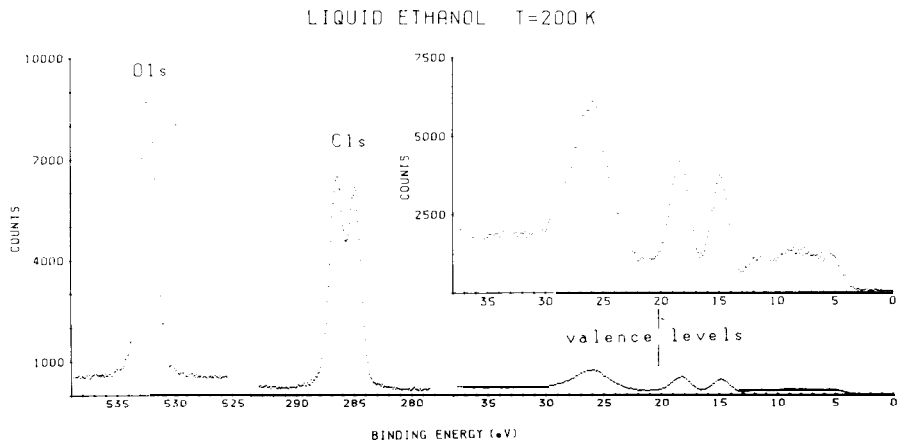

Fig. 13. ESCA spectrum of liquid ethanol obtained at T = 200K.

In the valence region for free molecules it was possible to achieve much improved resolution if UV light, especially the He resonance radiation at 21 eV was used for excitation. Development work in this field was performed by D. W. Turner [177-182] and W. C. Price [183, 184] and their coworkers in England. The conduction bands of metals could be studied by a corresponding technique using ultra-high vacuum (UHV) which was done by W. E. Spicer and coworkers [185-188] in the USA.

In my laboratory a large electrostatic sector focusing instrument was designed in the early part of the sixties for exciting electron spectra in the gaseous phase by VUV radiation and also by electrons. High resolution valence electron spectra were thus obtained and furthermore Auger and autoionization spectra of rare gases and organic molecules could be investigated at a resolution which enabled vibrational structures to appear also in the latter type of spectra. Studies of angular distributions were initiated by using polarized radiation. This was produced by VUV-polarizers which we developed in my laboratory. Much of the above work is described in theses by T. Bergmark [189], L. Karlsson [190], R. Jadrny [191] and L. Mattsson [192]. The Auger electron spectroscopy was further explored in more recent publications [128, 132, 193-196].

The source of excitation was for a time confined to either the soft X-ray region or the UV region with a gap between them from -50 eV (HeII) to 1250 eV ($\text{MgK}\alpha$). Fig. 14 shows the valence spectrum of SF_6 excited by HeI, HeII and $\text{AlK}\alpha$ [197, 198]. Some intermediate X-ray lines were later on added [199-205], such as $\text{YM}\zeta$ at 132 eV but the main step of development was the introduction during the seventies of the variable synchrotron radiation [e.g. 206-210] which partly bridged the gap. The previous strong distinction between X and UV excited electron spectra is therefore not so easy to maintain any more unless one is emphasizing the particular technique at hand for exciting the spectra. This is naturally not a trivial point for most researchers, however, and excellent work can be done with one or the other technique alone or in combination.

In 1967 we had gone through most of the basic features of the spectroscopy, designed several new spectrometers (electrostatic double focusing ones included), developed new radiation sources in the soft X-ray and UV region, made theoretical investigations of the process of electronic relaxation at ionization and applied the spectroscopy to a variety of different research fields. We then decided to present the new spectroscopy in a more consistent and complete way than we had done before. At the end of that year our book "ESCA-Atomic, Molecular and Solid State Structure Studied by Means of Electron Spectroscopy" appeared [211]. Two years later we published a second book [212], this time on "ESCA, Applied to Free Molecules". At that time several instrumental firms started to develop commercial instruments. I took part in one of these developments at Hewlett-Packard in Palo Alto during a leave of absence from my laboratory in 1968. I spent that year at the Lawrence Berkeley Laboratory with which we had had a long cooperation both in nuclear spectroscopy and then in ESCA. The Hewlett-Packard instrument [213] was designed to include

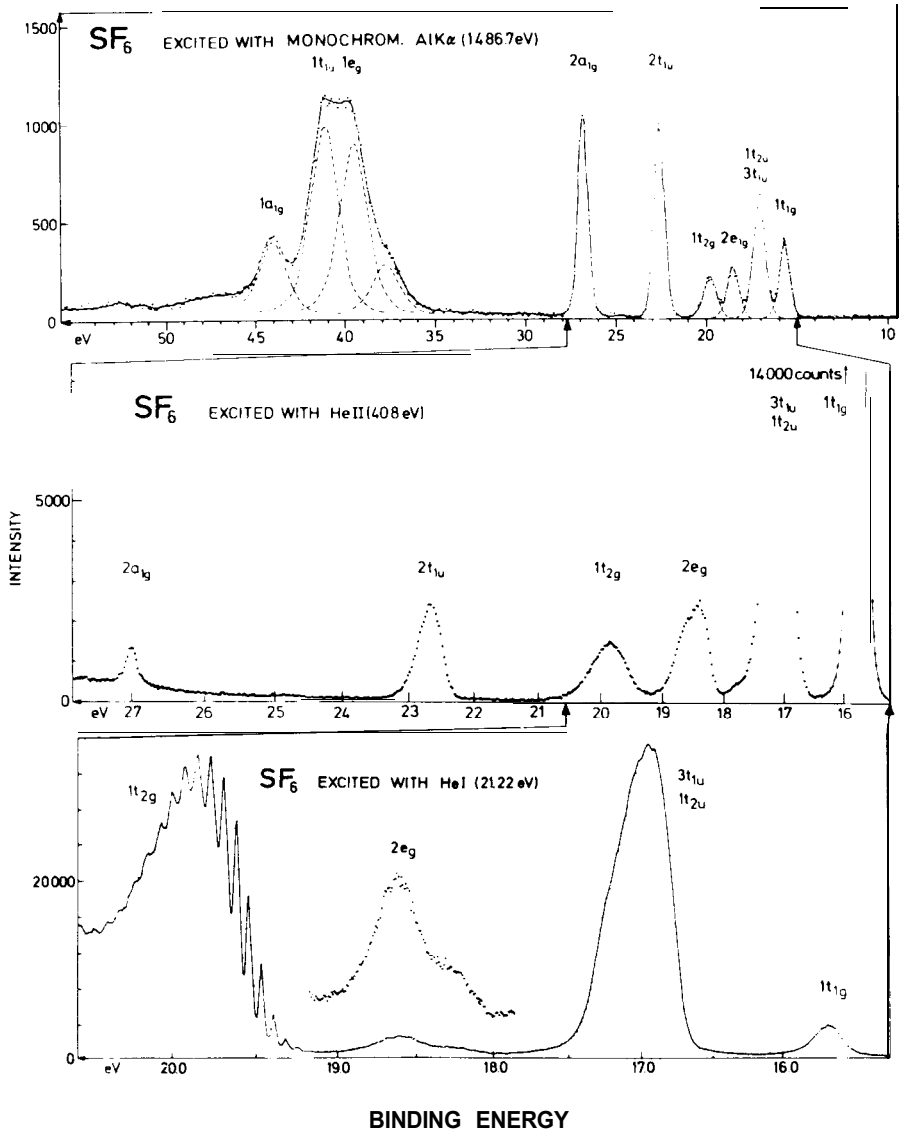

Fig. 14. Valence electron spectra of the SF_6 molecule excited with different photon energies ($\text{AlK}\alpha$ -, HeII and HeI -radiations). This figure illustrates the complementary nature of the various excitation sources. The $\text{AlK}\alpha$ -excited spectrum enables a recording of the full valence region (including the innermost orbitals), which is not possible with the lower photon energies. The higher resolution in the spectra excited with the He resonance radiations allows the study of finer details of each of the outer electron bands. Note also the strong variations in the relative intensities of the bands as a function of photon energy. This can be used as an aid in assigning the spectrum / 197.198/.

a monochromator for the $\text{AlK}\alpha$ radiation consisting of three spherically bent quartz crystals and a retarding electrostatic lens system to match the dispersion of these crystals to the electron spectrometer.

The spherically bent quartz crystal monochromator, having the property of being double focusing, was invented in my laboratory in 1958 [214] in quite another connection, namely in low angle scattering of X-rays against latex and other particles of biological interest [215]. The combination of double focusing both in the X-ray monochromator and in the electron analyzer has turned out to be essential for the further progress in ESCA. Other important technical developments have been the introduction of swiftly rotating water cooled anodes (U. Gelius), multidetector systems by means of electron channel plates and computerization of the instruments (E. Basilier).

In 1972 my coworker Ulrik Gelius and I made a new instrument [85, 216] with all these components included, in particular designed for the studies of gases. With the improved resolution of this instrument new structures could be resolved. One of principal interest was the discovery of the vibrational fine structure of core lines [82, 217]. Fig. 15 shows the line profile of the Cls in CH_4 . It turns out that this line can be separated into three components caused by the symmetric vibration when photoionization occurs in the 1s level of the central carbon atom. When the photoelectron leaves the methane molecule the latter shrinks about 0.05 Å. The minimum of the new potential curve for the ion will consequently be displaced by the corresponding amount and Franck-Condon transitions which take place will then give rise to the observed vibra-

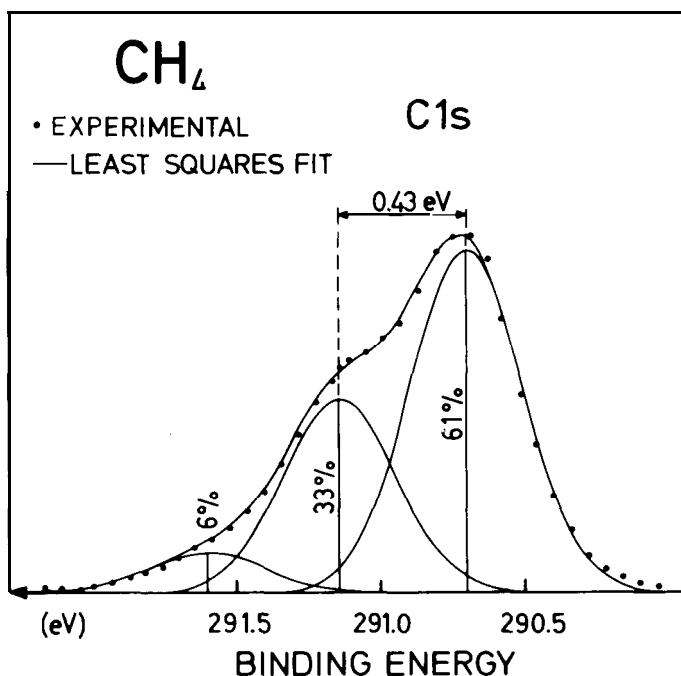

Fig. 15. Vibrational structure of the core electron line (Cl_s in CH_4). The line structure can be quantitatively explained as a consequence of the shrinkage of the equilibrium distances upon core electron mission [217].

tional fine structure of the electron line and with the intensities given by the Franck-Condon factors. This finding can be correlated with the simultaneously made discovery in our laboratory of vibrational fine structures in soft X-ray emission lines [218-233]. This development is further described in these work by L. O. Werme [234], J. Nordgren [235] and H. Ågren [236]. Combined, these results show that vibrations occur in these molecules during X-ray emission both in the initial and the final states.

The above high resolution instrument designed together with U. Gelius was planned to be a prototype instrument for a new generation of advanced instruments which have now been constructed in a recently built laboratory for electron spectroscopy in Uppsala [237]. These have just been finished and are the sixth generation in the sequence from my laboratory since 1954. Two of the new instruments are designed for molecular studies and the third for surface

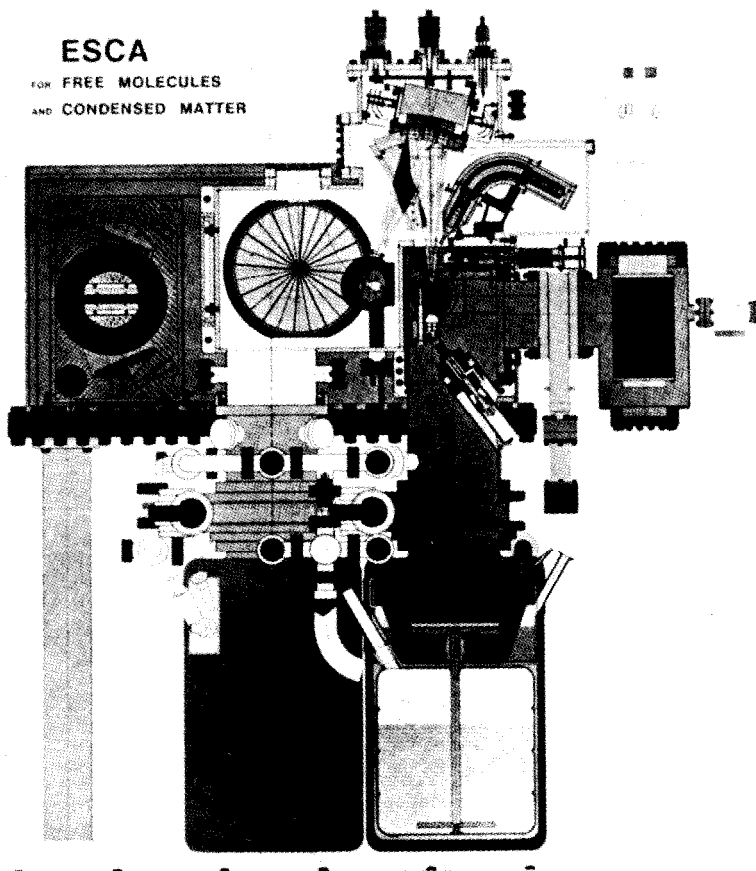

Fig. 16. Side view of the new ESCA instrument for free molecules and condensed matter. The instrument is UHV compatible and includes four different excitation modes (Monochromatized AlK α ; Monochromatized and polarized UV; electron impact; monochromatized electron impact).

studies. The spherical electrostatic analyzer ($R=36$ cm) is provided with an electrostatic lens system due to B. Wannberg [238]. The modes of excitation included in the instruments are: monochromatic $AlK\alpha$ radiation ($\Delta h\nu=0.2$ eV) at 1486.6 eV; a UV light source with a grating providing selected UV lines between 10 eV to ~ 50 eV; an electron monochromator of variable energy with an energy homogeneity of $\lesssim 10$ meV and an additional electron gun for Auger electron excitation, also variable in energy (Fig. 16). A polarizer for the UV light at different wavelengths can alternatively be used in angular distribution studies.

The new instrument has been put into operation. As an illustration of its improved qualities Fig. 17 shows a new investigation of the previously recorded spectrum of methane (compare with Fig. 15) under increased resolution [261]. The vibrational structure is now well resolved. A convolution of the recorded spectrum using the window curve of the spectrometer and a computer program yields a remaining spectrum consisting of three narrow lines, the widths (~ 100 meV) of which can be measured with good accuracy. For calibration purposes the Ar $2P_{1/2, 3/2}$ lines are simultaneously recorded. This investigation approaches an accuracy of a few meV in the determination of binding energies around 300 eV, i.e. close to $1:10^5$.

The brief account I have given above concerns the work which was done in my laboratory in the development of electron spectroscopy. During the seventies several reviews and books on electron spectroscopy have been written and for a complete account the reader has to go to such sources [239-258]. From my own laboratory two new books have just been completed authored by Hans Siegbahn and Leif Karlsson [259, 260], which cover developments mainly after 1970 and present current experimental and theoretical aspects on electron spectroscopy.

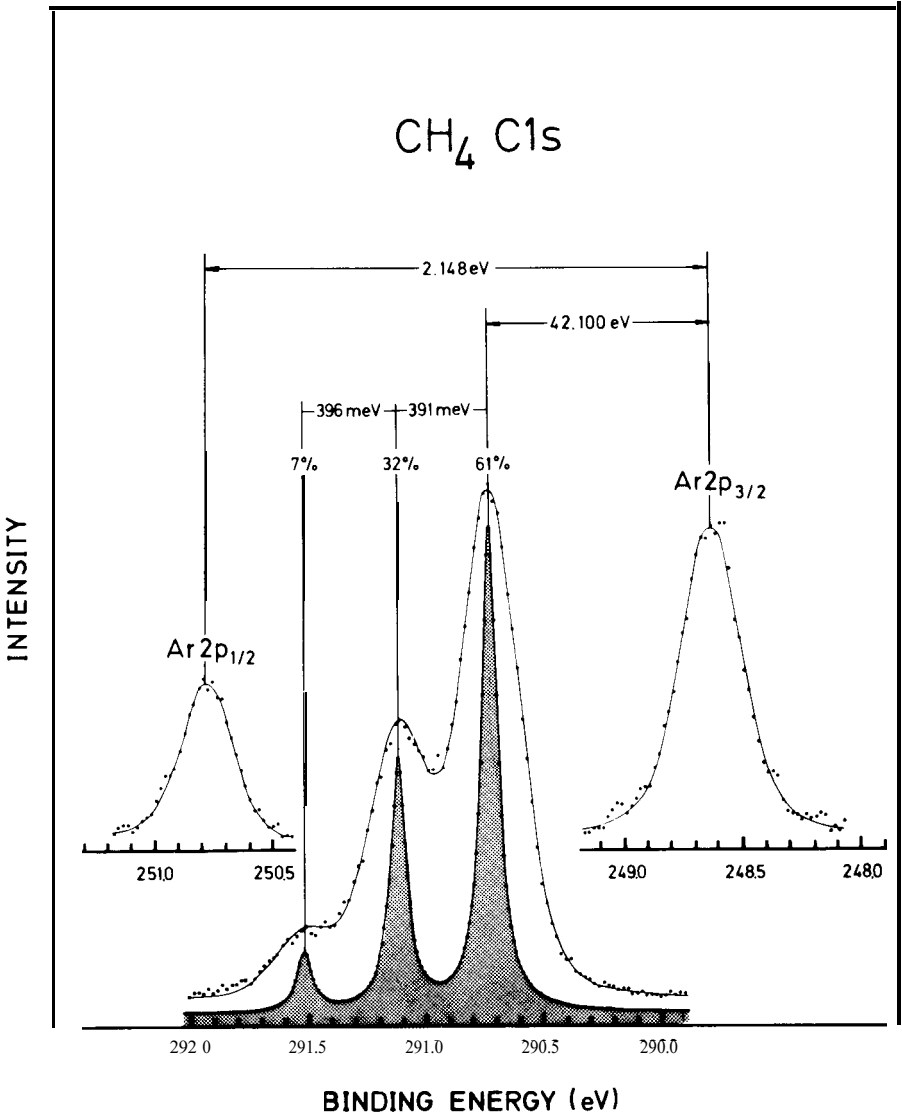

Fig. 17. New study of the methane C1s core vibrational structure (compare Fig. 15) by means of the instrument acc. to Fig. 16. The structure is resolved and deconvoluted into three narrow lines which yield the binding energies and widths of the components to a high degree of accuracy. Argon is used as a calibration gas, mixed with methane.

REFERENCE LIST

1. Siegbahn K., Studies in P-Spectroscopy (Thesis), Arkiv f. Mat. Astr., Fys. 30A, 1 (1944).
2. Siegbahn K., and Svartholm N., Nature 157, 872 (1946).
3. Svartholm N., and Siegbahn K., Arkiv f. Mat. Astr., Fys. 33A, 21 (1946).
4. Hedgran A., Siegbahn K., and Svartholm N., Proc. Phys. Soc. A63, 960 (1950).
5. Siegbahn K., in Alpha-, Beta- and Gamma-Ray Spectroscopy, ref. 25, p. 79.
6. Hofstadter R., Les Prix Nobel, 1961.
7. Lindström G., Nuclear Resonance Absorption Applied to Precise Measurements of Nuclear Magnetic Moments and the Establishment of an Absolute Energy Scale in P-Spectroscopy (Thesis). Ark. Fysik 4, 1 (1951).
8. Hedgran A., Precision Measurements of Nuclear Gamma-Radiation by Techniques of Beta-Spectroscopy (Thesis), Almqvist & Wiksell, Uppsala 1952.
9. Bergström I., The Isomers of Krypton and Xenon: An Investigation with Eletromagnetically Separated Radioactive Isotopes (Thesis). Ark. Fysik 5. 191 (1952).
10. Thulin S., Studies in Nuclear Spectroscopy) with Electromagnetically Separated Gaseous Isotopes (Thesis), Almqvist & Wiksell, Uppsala 1954.
11. Gerholm T.R., Coincidence Spectroscopy; Studies of Nuclear Magnetic Dipole Transition Probabilities and of Positron Annihilation Lifetimes. Design and Construction of an Electron-Electron Coincidence Spectrometer and Its Application to the Investigation of Some Complex Nuclear Disintegrations (Thesis). Almqvist & Wiksell, Uppsala 1956.
12. Lindqvist I., Angular Correlation Measurements: Studies of Relative Transition Probabilities of Gamma Radiation and of Internal Compton Effect. Experiments on Nuclear g-Factors (Thesis), Almqvist & Wiksell, Uppsala 1957.
13. Bäckström G., Levels and Transitions of Atomic Nuclei: Experiments and Experimental Methods (Thesis), Almqvist & Wiksell, Uppsala 1960.
14. Pettersson B.-G., Experimental Studies of Electron-Gamma Directional Correlations (Thesis), Almqvist & Wiksell, Uppsala 196 1.
15. Karlsson E., Studies of Excitation Modes of Atomic Nuclei by Means of Magnetic Moment Determinations and General Decay Investigations (Thesis). Acta Universitatis Upsaliensis 11, 1962.
16. Thun J.E., Studies of Nuclear Properties of Decay Modes of Radioactive Nuclei; Directional Correlation and Coincidence Investigations (Thesis). Acta Universitatis Upsaliensis 15, 1962.
17. Lindskog J., Studies of Nuclear Properties by Coincidence Spectrometer Methods; Decay Schemes and Transition Probabilities (Thesis), Acta Universitatis Upsaliensis 22. 1963.
18. Matthias E., Experimental and Theoretical Investigations of Perturbed Angular Correlations (Thesis), Almqvist & Wiksell, Uppsala 1963.
19. Schneider W., Applications of Digital Computer Techniques to Theoretical Investigations and the Analysis of Experimental Data in Nuclear Spectroscopy (Thesis), Almqvist & Wiksell, Uppsala 1963.
20. Bergman O., Experimental Studies of Nuclear States and Transitions (Thesis), Acta Universitatis Upsaliensis 41, 1964.
21. Sundström T., Electromagnetic Transitions in Atomic Nuclei: Experimental Studies of Transition Probabilities and Decay Schemes (Thesis). Acta Universitatis Upsaliensis 47, 1964.
22. Kleinheinz P., Studies of Internal Conversion Transitions in the Decay of Excited Nuclear States (Thesis), Almqvist & Wiksell, Uppsala 1965.
23. Bäcklin A., Nuclear Levels Excited in Neutron Capture Reactions and Radioactive Decays (Thesis), Acta Universitatis Upsaliensis 96, 1967.
24. Siegbahn K. (Editor), Beta- and Gamma Ray Spectroscopy, North-Holland Publ. Co., Amsterdam, 1955.
25. Siegbahn K. (Editor), Alpha-, Beta and Gamma Ray Spectroscopy, North-Holland Publ. Co., Amsterdam, 1965.
26. Jenkin J.G., Leckey R.C.G. and Liesegang J., J. Electron Spectrosc. 12, I (1977).

27. Carlson T.A. (Editor), X-ray Photoelectron Spectroscopy, Benchmark Papers in Phys. Chem. and Chem. Phys. Vol. 2, Dowden, Hutchinson and Ross (1978).
28. Siegbahn K., Conf. of the Swedish Nat. Committee for Physics, Stockholm, 1952, Ark. Fys. 7, 86 (1954).
29. Siegbahn K., Conf. of the Swedish Nat. Committee for Physics, Stockholm, 1953, Ark. Fys. 8, 19 (1954).
30. Siegbahn K., Introductory Talk at the Int. Conf. on Beta and Gamma Radioactivity, Amsterdam, 1952; Physica 18, 1043 (1952).
31. Siegbahn K. and Edvarson K., Nucl. Phys. 1, 137 (1956).
32. Sokolowski E., Edvarson K. and Siegbahn K., Nucl. Phys. 1, 160 (1956).
33. Nordling C., Siegbahn K., Sokolowski E. and Wapstra A.H., Nucl. Phys. 1, 326 (1956).
34. Nordling C., Sokolowski E. and Siegbahn K., Phys. Rev. 105, 1676 (1957).
35. Sokolowski E., Nordling C. and Siegbahn K., Ark. Fysik. 12, 301 (1957).
36. Robinson H., Phil. Mag. 50, 241 (1925).
37. Siegbahn K., Nordling C. and Sokolowski E., Proc. Rehovoth Conf. Nucl. Structure, North-Holland Publ. Co., Amsterdam, 1957, p. 291.
38. Sokolowski E., Nordling C. and Siegbahn K., Phys. Rev. 110, 776 (1958).
39. Nordling C., Sokolowski E. and Siegbahn K., Arkiv Fysik 13, 282 (1958).
40. Sokolowski E., Nordling C. and Siegbahn K., Arkiv Fysik 13, 288 (1958).
41. Nordling C., Sokolowski E. and Siegbahn K., Arkiv Fysik 13, 483 (1958).
42. Sokolowski E. and Nordling C., Arkiv Fysik 14, 557 (1959).
43. Sokolowski E., Arkiv Fysik 15, 1 (1959).
44. Nordling C., Arkiv Fysik 15, 241 (1959).
45. Nordling C., Arkiv Fysik 15, 397 (1959).
46. Nordling C. and Hagström S., Arkiv Fysik 15, 431 (1959).
47. Bergvall P. and Hagström S., Arkiv Fysik 16, 485 (1960).
48. Nordling C. and Hagström S., Arkiv Fysik 16, 515 (1960).
49. Bergvall P. and Hagström S., Arkiv Fysik 17, 61 (1960).
50. Bergvall P., Hörnfeldt O. and Nordling C., Arkiv Fysik 17, 113 (1960).
51. Nordling C., Hagström S. and Siegbahn K., Arkiv Fysik 22, 428 (1962).
52. Fahlman A., Hörnfeldt O. and Nordling C., Arkiv Fysik 23, 75 (1962).
53. Hagström S., Hörnfeldt O., Nordling C. and Siegbahn K. Arkiv Fysik 23, 145 (1962).
54. Hagström S., Nordling C. and Siegbahn K., "Alpha-, Beta- and Gamma-Ray Spectroscopy", Appendix 2. Ed. Siegbahn K., North-Holland Publ. Co., Amsterdam 1965.
55. Hagström S. and Karlsson S.-E., Arkiv Fysik 26, 252 (1964).
56. Hagström S. and Karlsson S.-E., Arkiv Fysik 26, 451 (1964).
57. Fahlman A. and Hagström S., Arkiv Fysik 27, 69 (1964).
58. Andersson I. and Hagström S., Arkiv Fysik 27, 161 (1964).
59. Nordling C. and Hagström S., Z. Phys. 178, 418 (1964).
60. Fahlman A., Hamrin K., Nordberg R., Nordling C. and Siegbahn K., Phys. Rev. Lett. 14, 127 (1965).
61. Fahlman A., Hamrin K., Nordberg R., Nordling C., Siegbahn K. and Holm L.W., Phys. Lett. 19, 643 (1966).
62. Hörnfeldt O. and Fahlman A., Arkiv Fysik 22, 412 (1962).
63. Hörnfeldt O., Fahlman A. and Nordling C., Arkiv Fysik 23, 155 (1962).
64. Hörnfeldt O., Arkiv Fysik 23, 235 (1962).
65. Hagström S., Z. Phys. 178, 82 (1964).
66. Fahlman A. and Nordling C. Arkiv Fysik 26, 248 (1964).
67. Fahlman A., Nordberg R., Nordling C. and Siegbahn K., Z. Phys. 192, 476 (1966).
68. Fahlman A., Hamrin K., Axelson G., Nordling C. and Siegbahn K., Z. Phys. 192, 484 (1966).
69. Fahlman A., Hamrin K., Nordberg R., Nordling C. and Siegbahn K., Phys. Lett. 20, 159 (1966).
70. Sokolowski E., Investigations of Inner Electron Shells by Spectroscopic Studies of Photo- and Auger Electrons (Thesis), Almqvist & Wiksell, Uppsala 1959.

71. Nordling C., Experimental Studies of Electron Binding Energies and Auger Spectra (Thesis), Almqvist & Wiksell, Uppsala 1959.
72. Bergvall P., Investigations of Atomic and Nuclear Energy Levels by Crystal Diffraction and Photo Electron Spectroscopy (Thesis), Almqvist & Wiksell, Uppsala 1960.
73. Hörnfeldt O., Studies of Atomic Level Energies and Auger Spectra (Thesis), Almqvist & Wiksell, Uppsala 1962.
74. Hagström S., Studies of Some Atomic Properties by Electron Spectroscopy (Thesis), Almqvist & Wiksell, Uppsala 1964.
75. Fahlman A., Electron Spectroscopy of Atoms and Molecules (Thesis), Acta Universitatis Upsaliensis 73, 1966.
76. Hagström S., Nordling C. and Siegbahn K., Phys. Lett. 9, 235 (1964).
77. Karlsson S.-E., Precision Electron Spectroscopy for Studies of Nuclear and Atomic Energy Levels (Thesis), Acta Universitatis Upsaliensis 99, 1967.
78. Nordberg R., ESCA Studies of Atoms and Molecules (Thesis), Acta Universitatis Upsaliensis 118, 1968.
79. Hamrin K., ESCA Applied to Solids and Gases (Thesis), Acta Universitatis Upsaliensis 151, 1970.
80. Hedman J., ESCA Studies of Electron Levels and Bands in Atoms, Molecules and Solids (Thesis), Acta Universitatis Upsaliensis 196, 1972.
81. Johansson G., Chemical Bonding and Electronic Structure of Molecules and Solids Studied by ESCA (Thesis), Acta Universitatis Upsaliensis 205, 1972.
82. Gelius U., Molecular Spectroscopy by Means of ESCA; Experimental and Theoretical Studies (Thesis), Acta Universitatis Upsaliensis 242, 1973.
83. Lindberg B., Some Aspects of the Sulphur-Oxygen Bond in Organic Sulphur Groups (Thesis), Acta Universitatis Upsaliensis 173, 1970.
84. ESCA I, ref. 211, p. 21.
85. Gelius U., Basilier E., Svensson S., Bergmark T. and Siegbahn K., J. Electron Spectrosc. 2, 405 (1974).
86. Siegbahn K., *ibid.* 5, 3 (1974).
87. Clark D.T., Dilks A., Shuttleworth S. and Thomas H.R., *ibid.*, 14, 247 (1978).
88. Clark D.T. and Dilks A., J. Polymer Sci. 16, 911 (1978).
89. Clark D.T., Phys. Scr. 16, 307 (1977).
90. Clark D.T., in Handbook of X-ray and UV Photoelectron Spectroscopy (Ed. D. Briggs) Heyden 1977, p. 211.
91. ESCA I, ref. 211, sect 111-9, p. 63.
92. Goscinski O., Howat G. and Åberg T., J. Phys. B8, 11 (1975).
93. Pickup B. and Goscinski O., Mol. Phys. 26: 1013 (1973).
94. Goscinski O., Hehenberger M., Roos B. and Siegbahn P., Chem. Phys. Lett. 33, 427, (1975).
95. ESCA II, ref. 212. Sect. 5.4.
96. Gelius U., Hedén P.-F., Hedman J., Lindberg B.J., Manne R., Nordberg R., Nordling C. and Siegbahn K., Phys. Scr. 2, 70 (I 970).
97. Lindberg B.J., Hamrin K., Johansson G., Gelius U., Fahlman A., Nordling C. and Siegbahn K., Phys. Scr. I, 286 (1970).
98. Allison D.A., Johansson G., Allan C.J., Gelius U., Siegbahn H., Allison J. and Siegbahn K., J. Electron Spectrosc. 1, 269 (1972/73).
99. Shirley D.A., Adv. Chem. Phys. 23, 85 (1973).
100. Clark D.T., in Electron Emission Spectroscopy. (Eds. Dekeyser et al.) D. Reidel Publ. Co. (1973).
101. Davis D.W., Banna M.S. and Shirley D.A., J. Chem. Phys. 60, 237 (1974).
102. Wyatt J.F., Hillier I.H., Saunders V.R., Connor J.A. and Barber M., J. Chem. Phys. 54, 5311 (1971).
103. Jolly W.L. and Perry W.B., Inorg. Chem. 13, 2686 (1974).
104. Jolly W.L. and Perry W.B., J. Amer. Chem. Soc. 95, 5442 (1974).
105. Carver, J. C., Gray R. C. and Hercules, D. M., J. Amer. Chem. Soc. 96, 6851 (1974).
106. Perry, W. B. and Jolly, W. L., Inorg. Chem. 13, 1211 (1974).

107. Gelius, U., Johansson, G. Siegbahn, H. Allan, C. J., Allison, D. A., Allison J. and Siegbahn, K., J, *Electron Spectrosc. I*, 285 (1972/173).
108. Siegbahn, H., Mcdeiros R. and Goscinski, O. *ibid.* 8, 149 (1976).
109. Bagus P. S. and Hermann, K., *Solid State Comm.* 20, 5 (1976).
110. Ellis, D. E., Baerends, E. J., Adachi H. and Averill, F. W., *Surf. Sci.* 64, 649 (1977).
111. Ley, L. Kowalczyk, S. P., McFeely, F. R., Pollak R. A., and Shirley, D. A. *Phys. Rev.* B8, 2392 (1973).
112. Kowalzyk. S. P., Pollak. R. A.. McFeely, F. R., Ley L. and Shirley, D. A., *ibid.* B8, 2387 (1973).
113. Shirley, D. A., Martin. R. L., Kowalczyk. S. P.. McFeely F. R. and Ley, I,.. *Phys. Rev.* B15, 544 (1977).
114. Svensson, S., Mårtensson N., Basilicr, E., Malmquist, P. Å., Gelius U. and Siegbahn, K., J. *Electron Spctrosc.* 9, 51 (1976).
115. Jen, J. S. and Thomas, T. D.. *Phys. Rev.* B13, 5284 (1976).
116. Johansson B. and Mårtensson, N.. *ibid.* B21. 4427 (1980).
117. Mårtensson, N., *Atomic, Molecular and Solid State Effects in Photoelectron Spectroscopy* (Thesis), Acta Universitatis Upsalensis 579. Uppsala 1980.
118. Nyholm. R., *Electronic Structure and Photoionization Studied by Electron Spectroscopy* (Thesis). Acta Universitatis Upsaliensis 581, Uppsala 1980.
119. Mårtensson, N., Nyholm, R., Calén. H.. Hedman, J. and Johansson. B. Uppsala University, Institute of Physics Report, UUIP-1008 (July 1980).
120. Kowalczyk, S. P., Pollak. R. A., McFerly. F. R. and Shirley, D. A., *Phys. Rev.* B8, 3583 (1973).
121. Kowalczyk. S. P.. Ley. L., McFeely. F. R., Pollak, R. A. and Shirley, D. A.. *Phys Rev.* B9, 381 (1974).
122. Wagner. C. D. and Biloen, P. *Surf. Sci.* 35. 82 (1973).
123. Matthew, J. A. D.. *Surf. Sci.* 40, 451 (1973).
124. Utriainen, J., Linkoaho. M. and Åberg, T.. in *Proc. Int. Symp. X-ray Sp. and El. Str. of Mat.* 1, 382 (1973).
125. Asplund, L., Kelfve, P., Siegbahn. H.. Goscinski. O.. Fellncr-Feldegg, H., Hamrin, K., Blomster. B. and Siegbahn. K., *Chem. Phys. Lett.* 40, 353 (1976).
126. Keski-Rahkonen. O. and Krause. M. O., *J. Electron Spectrosc.* 9, 371 (1976).
127. Sieghahn. H. and Goscinski. O.. *Phys. Scr.* 13. 225 (1976).
128. Asplund, L. , Kelfve, P., Blomster, B., Siegbahn. H.. Siegbahn, K., Lozes, R. L. and Wahlgren U. I., *Phys. Scr.* 16. 273 (1977).
129. Kim, K. S., Gaarcnstrom. S. W. and Winograd, N.. *Chem. Phys. Lett.* 41, 503 (1976).
130. Wagner, C. D., *Far. Disc. Chem. Soc.* 60, 291 (1975).
131. Wagner. C. D., in *Handbook of X-ray and Ultraviolet Photoelectron Spectroscopy* (Ed. D. Briggs) Chapt. 7 (Heyden. 1977).
132. Kelfvc, P., Blomster, B., Siegbahn, H., Siegbahn. K., Sanhueza, E. and Goscinski O., *Phys. Scr.* 21, 75 (1980).
133. Thomas. T. D., *J. Electron Spectrosc.* 20. 117 (1980).
134. ESCA I, ref. 21 1. p. 118.
135. Pignataro, S. and Distefano. G., J, *Electron Spectrosc.* 2, 171 (1973). *Z. Naturforsch.* 30a, 815 (1975).
136. Ågren, H., Roos, B., Bagus, P. S., Gelius. U., Malmquist, P. Å., Svensson, S., Maripuu, R. and Siegbahn, K., Uppsala University, Institute of Physics Report, UUIP-1057 (1982).
137. Yin, L., Adler, I., Tsang, T., Mantienzo, L. J. and Grim, S. O., *Chem. Phys. Lett.* 24, 81 (1974).
138. Pignataro, S., Foffani, A. and Distefano, G., *Chem. Phys. Lett.* 20, 350 (1973).
139. Johansson, L. Y., Larsson, R., Blomquist, J., Cederström, C., Grapengiesser, S., Helgeson, U., Moberg, L. C. and Sundhom, M., *Chem. Phys. Lett.* 24, 508 (1974).
140. Barber, M., Connor, J. A. and Hillier, I. H., *Chem. Phys. Lett.* 9, 570 (1971).
141. Hüfner, S. and Wertheim, G. K., *Phys. Rev.* B7. 5086 (1973).
142. Rosencwaig, A., Wertheim, G. K. and Guggenheim, H. J.. *Phys. Rev. Lett.* 27, 479 (1971).

143. Rosenzweig, A. and Wertheim, G. K., *J. Electron Spectrosc.* 1, 493 (1973).
144. Frost, D. C., McDowell, C. A. and Woolsey, I. S., *Chem. Phys. Lett.* 17, 320 (1972).
145. Kim, K. S., *Chem. Phys. Lett.* 26, 234 (1974).
146. Carlson, T. A., Carver, J. C., Saethre, L. J., Santibanez, F. G. and Vernon, G. A., *J. Electron Spectrosc.* 5, 247 (1974).
147. Fuggle, J. C., Umbach, E., Menzel, D., Wandelt, K. and Brundle, C. R., *Solid State Comm.* 27,65 (1978).
148. Lang, N. D. and Williams, A. R., *Phys. Rev.* B16, 2408 (1977).
149. Schönhammer, K. and Gunnarsson. O.. *Solid State Comm.* 23. 691 (1978) and 26. 399 (1978) and *Z.*, *Phys.* B30, 297 (1978).
150. Hedman, J., Hedén. P. F., Nordling, C. and Siegbahn. K., *Phys. Lett.* A29. 178 (1969).
151. ESCA II. ref 212, section 5.1, p 56.
152. ESCA I, ref. 21 I, section IV, p. 72.
153. Siegbahn, K., Gelius, U., Siegbahn. H and Olsson. E., *Phys. Lett.* 32A. 221 (1970) and *Phys. Ser. I.* 272 (1970).
154. Fadley, C. S. and Bergström S. Å. I., *Phys Lett.* 35A, 373 (1971).
155. Baird. R.J., Fadley. C. S. and Wagner. I., *F.. Phy. Rev.* B15. 666 (1977).
156. Zehner, D.M., Noonan, J. R. and Jenkins. L. H.. *Phys. Lett.* 62A. 267 (1977).
157. Briggs. D.. Marbrow. R. A. and Lambert. R. M . *Solid State Comm.* 25. 40 (1978).
158. Erickson. N. E.. *Phys. Ser.* 16, 462 (1977).
159. Kono, S., Goldberg, S. M., Hall, N. F. T. and Fadley. C S.. *Phys. Rev. Lett.* 41, 1831 (1978).
160. Petersson, L., G., Kono. S., Hall. N. F T.- . Fadley C S. and Pendry, J B.. *Phys. Rev. Lett* 42, 1545 (1979).
161. Woodruff, D. P., Norman. D., Holland. B. W., Smith. N. W., Farrell. H. H. and Traum. M.. *Phys. Rev. Lett.* 41, 1 130 (1978).
- t 62. Kevan. S. D., Rosenblatt. D., H . Denley. D. R., Lee. B.-C.: and Shirley. D. A., *Phys. Rev.* B20. 4133 (1979); *Phys. Rev. Lett.* 41. 156.5 (1978).
163. McGovern, I. T., Eberhardt. W. and Plummer. E. W.. *Sol. St. Comm.* 32, 963 (1979).
164. Guillot. C., Jugnet. Y., Lasailly, Y., Lecante, J., Spanjaard. D. and Duc. T. M. (private communication. 1980).
165. Bergmark. T . Magnusson. N. and Siegbahn. K.. *Ark. Fys.* 37. 3.53 (1968).
166. ESCA I. ref. 211 , p 20.
167. ESCA I. ref. 211, p. 21.
168. Siegbahn. H. and Siegbahn. K., *J. Electron Spectrosc.* 2. 319 (1973).
169. Sieghahn. H.. Asplund, L., Kelfve. P., Hamrin. K., Karlsson. I., and Siegbahn. K. ,*J Electron Spectrosc.* 5, 1059 (1974).
170. Siegbahn. H., Asplund. L., Kelfve. P. and Siegbahn. K., *J. Electron Spectrosc.* 7. 411 (1975).
171. Fellner-Feldegg. H., Siegbahn. H., Asplund. L., Kelfve. P. and Siegbahn. K., *J. Electron Spectrosc.* 7. 421 (1975).
172. Lindberg. B Asplund. L., Fellner-Feldegg. H., Kelfve. I., Siegbahn. H. and Siegbahn K.. *Chem. Phys. Lett.* 79, 8 (1976).
173. Siegbahn. H., Svensson, S. and Lundholm. M., *J. Electron Spectrosc.* 24, 205 (1981). The first considerations of continuously renewable liquid samples in vacuum for ESCA and experiments on liquid beams were reported at the Asilomar conference 1971: K. Siegbahn: Perspectives and Problems in Electron Spectroscopy. (Editor: D. Shirley), North Holland, 1972. Further accounts for these developments are found in ref. /168/-/172/. Different suggested alternatives for handling the renewable samples (liquid beams, wetted rotating wires and rotating disks) were presented at the Namur Conference 1974, K. Siegbahn: Electron Spectroscopy-An Outlook (secs 3 and 4, figs 5-10). Editors: R. Caudano and J. Verbist, Elsevier, 1974. References to recent other works on liquids are found in H. Siegbahn et. al. ref. /173/ (R. Ballard et. al. see ref. ibid. 6 and 7; P. Delahay et. al. ref. ibid. 8-10; K. Burger et. al. ref. ibid. 11 and 12; S. Avanzino and W. Jolly ref. ibid. 13).
174. Siegbahn, H., *ESCA Studies of Electronic Structure and Photoionization in Gases, Liquids and Solids (Thesis)*, Acta Universitatis Upsaliensis 277, Uppsala 1974.

175. Asplund, L., Electron Spectroscopy of Liquids and Gases (Thesis), Acta Universitatis Upsaliensis 409, Uppsala 1977.
176. Kelfve, P., Electronic Structure of Free Atoms, Molecules and Liquids Studied by Electron Spectroscopy (Thesis), Acta Universitatis Upsaliensis 483, Uppsala 1978.
177. Turner, D. W. and Al-Joboury, M. I., J. Chem. Phys. 37, 3007 (1962).
178. Turner, D. W. and Al-Joboury, M. I., Chem. Soc., London, 5141 (1963).
179. Al-Joboury, M. I., May, D. P. and Turner, D. W., J. Chem. Soc., 616,4434, 6350 (1965).
180. Radwan, T. N. and Turner D. W., J. Chem. Soc., 85 (1966).
181. Al-Joboury, M. I. and Turner, D. W., J. Chem. Soc., 373 (1967).
182. Turner, D. W., Baker, C., Baker, A. D. and Brundle, C. R., Molecular Photoelectron Spectroscopy, Wiley-Interscience, London (1970).
183. Price, W. C., Endeavour 26, 78 (1967).
184. Lemпка, H. J., Passmore, T. R. and Price, W. C., Proc. Roy. Soc. A304, 53 (1968).
185. Berglund, C. N. and Spicer, W. E., Phys. Rev. 136, A1030; A1044 (1964).
186. Spicer, W. E., J. Appl. Phys. 37, 947 (1966).
187. Blodgett, A. J., Jr., and Spicer, W. E., Phys. Rev. 146, 390 (1966).
188. Blodgett, A. J., Jr. and Spicer, W. E. Phys. Rev. 158, 514 (1967).
189. Bergmark, T., Electronic Structure of Atoms and Molecules Studied by Means of Electron Spectroscopy (Thesis), Acta Universitatis Upsaliensis 274, 1974.
190. Karlsson, L., High Resolution Studies of the Valence Electron Structure of Atoms and Molecules by Means of Electron Spectroscopy (Thesis), Acta Universitatis Upsaliensis 429, 1977.
191. Jadmy, R., Electronic Structure Studied by Electron Spectroscopy and Angular Distributions (Thesis), Acta Universitatis Upsaliensis 463, 1978.
192. Mattsson, L., High Resolution Valence Electron Spectroscopy. Development of a VUV-Polarizer for Angular Distributions (Thesis), Acta Universitatis Upsaliensis 562, 1980.
193. Asplund, L., Kelfve, P., Blomster, B., Siegbahn, H. and Siegbahn, K., Phys. Scr. 16, 268 (1977).
194. Siegbahn, H., Asplund, L. and Kelfve, P., Chem. Phys. Lett. 35, 330 (1975).
195. Siegbahn, H., in Excited States in Quantum Chemistry (Eds. Nicolaides C. A. and Beck, D. R.), Plenum (1978) p. 273.
196. Darko, T., Siegbahn, H. and Kelfve, P., Chem. Phys. Lett. 82, 475 (1981).
197. Karlsson, L., Mattsson, L., Jadmy, R., Bergmark, T. and Siegbahn, K., Phys. Scr. 14, 230 (1976).
198. Gelius, U., J. Electron Spectrosc. 5, 985 (1974).
199. Krause, M. O., Chem. Phys. Lett. 10, 65 (1971).
200. Wuilleumier, F. and Krause, M. O., Phys. Rev. A10, 242 (1974).
201. Banna, M. S. and Shirley, D. A., Chem. Phys. Lett. 33, 441 (1975), J. Electron Spectrosc. 8, 23 (1976); *ibid.* 8, 255 (1976).
202. Nilsson, R., Nyholm, R., Berndtsson, A., Hedman, J. and Nordling, C. J. Electron Spectrosc. 9, 337 (1976).
203. Berndtsson, A., Nyholm, R., Nilsson, R., Hedman, J. and Nordling, C. *ibid.* 13, 131 (1978).
204. Cavell, R. G. and Allison, D. A., Chem. Phys. Lett. 36, 514 (1975).
205. Allison, D. A. and Cavell, R. G., J. Chem. Phys. 68, 593 (1978).
206. Kunz, C. (Ed.), Synchrotron Radiation, Techniques and Applications, Topics in Current Physics 10, Springer-Verlag (1979).
207. Synchrotron Radiation Instrumentation and New Developments. Nuclear Instr. Meth. 152. (Conf. Vol., Eds: Wuilleumier, P. and Y. Farge) 1978.
208. Synchrotron Radiation Instrumentation. Nuclear Instr. Meth. 172 (Conf. Vol., Eds: Ederer, D. L. and West, J. B.) 1980.
209. Synchrotron Radiation Facilities, *ibid.* 177 Conf. Vol., Ed. Howells. 51. R.) 1980.
210. Synchrotron Radiation Research, Eds: Winick H. and Doniach, S., Plenum (1980).
211. Siegbahn, K., Nordling, C., Fahlman, A., Nordberg, R., Hamrin, K., Hedman, J., Johansson, G., Bergmark, T., Karlsson, S.-E., Lindgren, I. and Lindberg, B., ESCA - Atomic, Molecu-

- lar and Solid State Structure Studied by Means of Electron Spectroscopy, *Nova Acta Regiae Soc. Sci. Upsaliensis*, Ser. IV, Vol. 20 (1967).
212. Siegbahn, K., Nordling, C., Johansson, G., Hedman, J., Hedén, P. F., Hamrin, K., Gelius, U., Bergmark, T., Werme, L. O., Manne R. and Baer Y., *ESCA Applied to Free Molecules*, North-Holland Publ. Co., Amsterdam-London, 1969.
 213. Siegbahn, K., Hammond, D., Fellner-Feldegg, H. and Barnett, E. F., *Science* 176, 245 (1972).
 214. Wassberg, G. and Siegbahn, K., *Ark. Fys.* 14, 1 (1958).
 215. Hagström, S. and Siegbahn, K., *J. Ultrastructure Research* 3, 401 (1960).
 216. Gelius, U. and Siegbahn, K., *Far. Disc. Chem. Soc.* 54, 257 (1972).
 217. Gelius, U., Svensson, S., Siegbahn H., Basilier, E., Faxälv, Å, and Siegbahn, K., *Chem. Phys. Lett.* 28, 1 (1974).
 218. Siegbahn, K. in *Electron Spectroscopy* (Ed. D.A. Shirley), *Proc. Intern. Conf. Asilomar, California, USA, 1971*. North-Holland, Amsterdam, 1972.
 219. Siegbahn, K., Werme, L.O., Grennberg, B., Lindeberg, S. and Nordling, C. *Uppsala University Institute of Physics Report, UUIP-749* (Oct. 1971).
 220. Siegbahn, K., Werme, L.O., Grennberg, B., Nordgren, J. and Nordling, C, *Phys. Lett* 41A (2), 111 (1972).
 221. Werme, L.O., Grennberg, B., Nordgren, J., Nordling, C. and Siegbahn, K., *Phys. Lett* 41A (2), 113 (1972).
 222. Werme, L.O., Grennberg, B., Nordgren, J., Nordling, C. and Siegbahn, K., *Phys. Rev. Lett.* 30 (12), 523 (1973).
 223. Werme, L.O., Grennberg, B., Nordgren, J., Nordling, C. and Siegbahn, K., *Nature* 242 (5348), 453 (1973).
 224. Werme, L.O., Grennberg, B., Nordgren, J., Nordling, C. and Siegbahn, K., *J. Electron Spectrosc.* 2, 435 (1973).
 225. Werme, L.O., Nordgren, J., Nordling, C. and Siegbahn, K., *C.R. Acad. Sci. Paris*, B-119, 279 (1974).
 226. Nordgren, J., Werme, L.O., Ågren, H., Nordling, C. and Siegbahn, K., *J. Phys.* B8(1), L18 (1975).
 227. Werme, L.O., Nordgren, J., Ågren, H., Nordling, C. and Siegbahn, K., *Z. Physik* 272, 131 (1975).
 228. Nordgren, J., Ågren, H., Werme, L.O., Nordling, C. and Siegbahn, K., *J. Phys.* B9 (2), 295 (1976).
 229. Nordgren, J., Ågren, H., Selander, L., Nordling, C. and Siegbahn, K., paper presented at the *Nordic Symposium on Atomic and Molecular Transition Probabilities in Lund, March 28-29, 1977*.
 230. Nordgren, J., Ågren, H., Nordling, C. and Siegbahn, K., *Ann. Acad. Reg. Scientiarum Upsaliensis* 21, 23 (1978).
 231. Ågren, H., Nordgren, J., Selander, L., Nordling, C. and Siegbahn, K., *Phys. Scr.* 18, 499 (1978).
 232. Nordgren, J., Ågren, H., Pettersson, L., Selander, L., Griep, S., Nordling, C. and Siegbahn, K., *Phys. Scr.* 20, 623 (1979).
 233. Ågren, H., Selander, L., Nordgren, J., Nordling, C., Siegbahn, K. and Müller, J., *Chem. Phys.* 37, 161 (1979).
 234. Werme, L.O., *Electron and X-ray Spectroscopic Studies of Free Molecules* (Thesis), *Acta Universitatis Upsaliensis* 241, 1973.
 235. Nordgren, J., *X-ray Emission Spectra of Free Molecules* (Thesis) *Acta Universitatis Upsaliensis* 418, 1977.
 236. Ågren, H., *Decay and Relaxation of Core Hole States in Molecules* (Thesis), Uppsala 1979.
 237. Siegbahn, K. in *Electron Spectroscopy*, Eds. Hedman, J. and Siegbahn, K., *Phys. Scr.* 16, 167, (1977).
 238. Wannberg, B. and Sköllermo, A., *J. Electron Spectrosc.* 10, 45 (1977).
 239. *Phil. Trans. Roy. Soc. (London)* 268, 1-175 (1970).
 240. Shirley, D.A. (Ed.) *Electron Spectroscopy*, North-Holland, Amsterdam (1972).
 241. *Faraday Disc. Chem. Soc.* 54 (1972).

242. Dekeyser, W., et al. (Eds.) *Electron Emission Spectroscopy*, Reidel (1973)
243. Caudano, R. and Verbist, J. (Eds.) *Electron Spectroscopy*, Elsevier Amsterdam (1974)
244. *Electron Spectroscopy of Solids and Surfaces*, Far. Disc. Chem. Soc. 60 (1975).
245. Proc. Int. Symp. Electron Spectroscopy, Uppsala (May 1977), (Eds. Hedman, J, and Siegbahn, K.) *Phys. Scr.* 16 (5-6) (1977).
246. Proc. Australian Conf. on Electron Spectroscopy, *J. Electron Spectrosc.* 15 (1979).
247. Baker, A.D. and Betteridge, D., *Photoelectron Spectroscopy*, Pergamon Press (1972).
248. Eland, J.H.D., *Photoelectron Spectroscopy*, Butterworths, London (1974).
249. Carlson, T.A., *Photoelectron and Auger Spectroscopy*. Plenum Press, New York (1975).
250. Brundle, C.R. and Baker, A.D. (Eds.) *Electron Spectroscopy*. Academic Press Vol.1 (1977), Vol. 2 (1978), Vol. 3 (1979). Vol. 4 (1981).
251. Briggs, D. (Ed.), *Handbook of X-ray and Ultraviolet Photoelectron Spectroscopy*, Heyden (1977).
252. Rabalais, J.W., *Principles of Ultraviolet Photoelectron Spectroscopy*, Wiley-Interscience (1977).
253. Ghosh. P.K., *A Whiff of Photoelectron Spectroscopy*, Swan Printing Press. New Delhi (1978).
254. Photoemission and the Electronic Properties of Surfaces (Eds. Feuerbacher, B., Fitton, B. and Willis. R.F.) Wiley-Interscience (1978).
253. Photoemission in Solids (Eds. Cardona. M. and Ley. I.). *Topics in Applied Physics* Vol. 26. 27, Springer-Verlag (1978. 1979).
256. Roberts, M.W, and McKee, C.S., *Chemistry of. the Metal-Gas Interface*. Clarendon Press (1978).
257. Ballard. R.E.. *Photoelectron Spectroscopy and Molecular Orbital Theory*, Adam Hilger (1978).
258. Berkowitz. J., *Photoabsorption, Photoionization and Photoelectron Spectroscopy*. Academic Press (1979).
259. Siegbahn, H. and Karlsson. I., *Photoelectron Spectroscopy*, *Handbuch d. Physik*. Vol.31 (Ed. Mehlhorn. W.) Springer-Verlag (1982).
260. Siegbahn, H. and Karlsson. I.. *Electron Spectroscopy for Atoms, Molecules and Condensed Matter*, North-Holland, Publ. Co. (to be published).
261. Gelius, U., Helenelund. K., Hedman, S.. Asplund, L.. Finnström, B. and Siegbahn, K. (to be published).