

# THE DEVELOPMENT OF THE ELECTRON MICROSCOPE AND OF ELECTRON MICROSCOPY

Nobel lecture, December 8, 1986

by

ERNST RUSKA

Max-Eyth-Strasse 20, D-1000 BERLIN 33

## *A. Parents' house, family*

A month ago, the Nobel Foundation sent me its yearbook of 1985. From it I learnt that many Nobel lectures are downright scientific lectures, interspersed with curves, synoptic tables and quotations. I am somewhat reluctant to give here such a lecture on something that can be looked up in any modern schoolbook on physics. I will therefore not so much report here on physical and technical details and their connections but rather on the human experiences - some joyful events and many disappointments which had not been spared me and my colleagues on our way to the final breakthrough. This is not meant to be a complaint though; I rather feel that such experiences of scientists in quest of new approaches are absolutely understandable, or even normal.

In such a representation I must, of course, consider the influence of my environment, in particular of my family. There have already been some scientists in my family: My father, Julius Ruska, was a historian of sciences in Heidelberg and Berlin; my uncle, Max Wolf, astronomer in Heidelberg; his assistant, a former pupil of my father and my godfather, August Kopff, Director of the Institute for astronomical calculation of the former Friedrich-Wilhelm University in Berlin. A cousin of my mother, Alfred Hoche, was Professor for Psychiatry in Freiburg/Breisgau; my grandfather from my mother's side, Adalbert Merx, theologian in Gießen and Heidelberg.

My parents lived in Heidelberg and had seven children. I was the fifth, my brother Helmut the sixth. To him I had particularly close and friendly relations as long as I can remember. Early, optical instruments made a strong impression on us. Several times Uncle Max had shown us the telescopes at the observatory on the Königstuhl near Heidelberg headed by him. With the light microscope as well we soon had impressive, yet contradictory, relations. In the second floor of our house, my father had two study rooms connected by a broad sliding door which usually was open. One room he used for his scientific historical studies relating to classical philology, the other for his scientific interests, in particular mineralogy, botany and zoology. When our games with neighbours' kids in front of the house became too noisy, he would knock at the window panes. This

usually only having a brief effect, he soon knocked a second time, this time considerably louder. At the third knock, Helmut and I had to come to his room and sit still on a low wooden stool, dos à dos, up to one hour at 2 m distance from his desk. While doing so we would see on a table in the other room the pretty yellowish wooden box that housed my father's big Zeiss microscope, which we were strictly forbidden to touch. He sometimes demonstrated to us interesting objects under the microscope, it is true; for good reasons, however, he feared that childrens' hands would damage the objective or the specimen by clumsy manipulation of the coarse and line drive. Thus, our first relation to the value of microscopy was not solely positive.

### *B. School, vocational choice*

Much more positive was, several years later, the excellent biology instruction my brother had through his teacher Adolf Leiber and the very thorough teaching I received through my teacher Karl Reinig. To my great pleasure I recently read an impressive report on Reinig's personality in the Memoirs of a two-years-older student at my school, the later theoretical physicist Walter Elsasser. Even today I remember the profound impression Reinig's comments made upon me when he explained that the movement of electrons in an electrostatic field followed the same laws as the movement of inert mass in gravitational fields. He even tried to explain to us the limitation of microscopical resolution due to the wavelength of light. I certainly did not clearly understand all this then, because soon after that on one of our many walks through the woods around Heidelberg I had a long discussion on that subject with my brother Helmut, who already showed an inclination to medicine, and my classmate Karl Deißler, who later studied medicine as well.

In our College (Humanistisches Gymnasium), we had up to 17 hours of Latin, Greek and French per week. In contrast to my father, who was extremely gifted for languages, I produced only very poor results in this field. My father, at that time teacher at the same school, daily learnt about my minus efforts from his colleagues and blamed me for being too lazy, so that I had some sorrowful school years. My Greek teacher, a fellow student of my father, had a more realistic view of things: He gave me for my confirmation the book "Hinter Pflug und Schraubstock" (Behind plow and vise) by the Swabian "poet" engineer Max Eyth (1836-1906). I had always been fascinated by technical progress; in particular I was later interested in the development of aeronautics, the construction of airships and air planes. The impressive book of Max Eyth definitely prompted me to study engineering. My father, having studied sciences at the universities of Straßburg, Berlin and Heidelberg, obviously regarded study at a Technical High School as not being adequate and offered me one physics semester at a university. I had, however, the strong feeling that engineering was more to my liking and refused.

### *C. The cathode-ray oscillograph and the short coil*

After I had studied two years electrotechnical engineering in Munich, my father received a call to become head of a newly founded Institute for the

History of Sciences in Berlin in 1927. Thus, after my pre-examination in Munich I came to Berlin for the second half of my studies. Here I specialized in high-voltage techniques and electrical plants and heard, among others, the lectures of Professor Adolf Matthias. At the end of the summer term in 1928 he told us about his plan of setting up a small group of people to develop from the Braun tube an efficient cathode-ray oscillograph for the measurement of very fast electrical processes in power stations and on open-air high-voltage transmission lines. Perhaps with the memory of my physics school lesson in the back of my head, I immediately volunteered for this task and became the youngest collaborator of the group, which was headed by Dr. Ing. Max Knoll. My first attempts with experimental work had been made in the practical physics course at the Technical High School in Munich under Professor Jonathan Zenneck, and now in the group of Max Knoll. As a newcomer I was first entrusted with some vacuum-technical problems which were important to all of us. Through the personality of Max Knoll, there was a companionable relationship in the group, and at our communal afternoon coffee with him the scientific day-to-day-problems of each member of the group were openly discussed. As I did not dislike calculations, and our common aim was the development of cathode-ray oscillographs for a desired measuring capability, I wanted to devise a suitable method of dimensioning such cathode-ray oscillographs in my "Studienarbeit" - a prerequisite for being allowed to proceed to the Diploma examination.

The most important parameters for accuracy of measurement and writing speed of cathode-ray oscillographs are the diameter of the writing spot and its energy density. To produce small and bright writing spots, the electron beams emerging divergently from the cathode had to be concentrated in a small writing spot on the fluorescent screen of the cathode-ray oscillograph. For this, already Rankin in 1905 [1] used a short dc-fed coil, as had been used by earlier experimentalists with electron beams (formerly called "glow" or "cathode rays"). Even before that, Hittorf (1869) and Birkeland (1896) used the rotationally symmetric field lying in front of a cylindrical magnet pole for focussing cathode rays. A more precise idea of the effect of the axially symmetric, i.e. inhomogeneous magnet field of such poles or coils on the electron bundle alongside of their axes had long been unclear.

Therefore, Hans Busch [3] at Jena calculated the electron trajectories in such an electron ray bundle and found that the magnetic field of the short coil has the same effect on the electron bundle as has the convex glass lens with a defined focal length on a light bundle. The focal length of this "magnetic electron lens" can be changed continuously by means of the coil current. Busch wanted to check experimentally his theory but for reasons of time he could not carry out new experiments. He made use of the experimental results he had already obtained sixteen years previously in Gottingen. These were, however, in extremely unsatisfactory agreement with the theory. Perhaps this was the reason that Busch did not draw at least the practical conclusion from his lens theory to image some object with such a coil.

In order to account more precisely for the properties of the writing spot of a cathode-ray oscillograph produced by the short coil, I checked Busch's lens theory with a simple experimental arrangement under better, yet still inadequate, experimental conditions (Fig. 1) and thereby found a better but still not entirely satisfactory agreement of the imaging scale with Busch's theoretical

Abbildung des zum Versuch  
benutzten Kathodenstrahl-  
oszillographen.

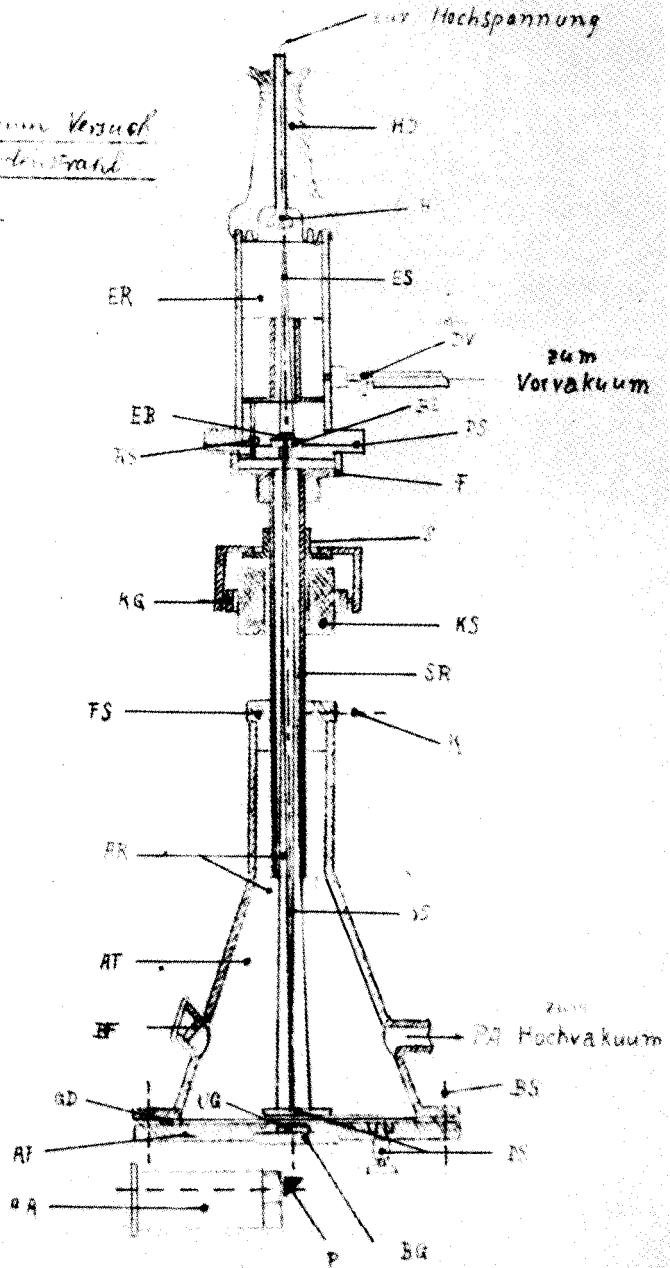

Fig. 1: Sketch by the author (1929) of the cathode ray tube for testing the imaging properties of the non-uniform magnetic field of a short coil [4. 5].

expectation. The main reason was that I had used a coil of the dimensions of Busch's coil whose field distribution along the axis was much too wide. My Studienarbeit [4], submitted to the Faculty for Electrotechnical Engineering in 1929, contained numerous sharp images with different magnifications of an electron-irradiated anode aperture of 0.3 mm diameter which had been taken by means of the short coil ("magnetic electron lens") - i. e. the first recorded electron-optical images.

Busch's equation for the focal length of the magnetic field of a short coil implied that a desired focal length could be produced by the fewer ampere turns the more the coil field was limited to a short region alongside the axis, because in that case the field maximum is increased. It was therefore logical for me as a prospective electrotechnical engineer to suitably envelop the coil with an iron coating, with a ring-shaped gap in the inner tube. Measurements at such a coil immediately showed that the same focal length had been reached with markedly fewer ampere turns [4,5]. Vice versa, in this manner a shorter focal length can, of course, also be obtained by an equal number of ampere turns.

#### *D. Why I pursued the magnetic electron lens for the electron microscope*

In my Diploma Thesis (1930) I was to search for an electrostatic replacement for the magnetic concentration of the divergent electron ray bundle, which would probably be easier and cheaper. To this end, Knoll suggested experimental investigation of an arrangement of hole electrodes with different electrical potential for which he had taken out a patent a year before [6]. We discussed the shape of the electric field between these electrodes, and I suggested that because of the mirror-like symmetry of the electrostatic field of the electrodes on either side of the lens centre, a concentrating effect of the curved equipotential planes in the hole area could not take place. I only had the field geometry in mind then. But this conclusion was wrong. I overlooked that as a consequence of the considerably varying electron velocity on passage through such a field arrangement, a concentration of the divergent electron bundle must, in fact, occur. Knoll did not notice this error either. Therefore I pursued another approach in my Diploma Thesis [7]. I made the electron bundle pass a bored-out spherical condenser with fine-meshed spherically shaped grids fixed over each end of the bore. With this arrangement I obtained laterally inverted images in the correct imaging scale. Somewhat later I found a solution which was unfortunately only theoretically correct. In analogy to the refraction of the light rays on their passage through the optical lens at their surfaces ("Grenzflächen"), I wanted to use, for the electrical lens, the potential steps at corresponding surfaces, which are shaped like glasses lenses [8]. Thus, the energy of the electron beams is temporarily changed-just like light beams on passage through optical lenses. For the realization of this idea, on each side of the lens two closely neighboured fine-meshed grids of the shape of optical lenses are required which must be kept on electrical potentials different from each other. First attempts confirmed the rightness of this idea, but at the same time also the practical inaptness of such grid lenses because of the too-strong absorption of

the electron beam at the four grids and due to the field distribution by the wires.

As a consequence of my false reasoning and the experimental disappointment I decided to continue with the magnetic lens. I only report this in so much detail to show that occasionally it can be more a matter of luck than of superior intellectual vigor to find a better-or perhaps the only acceptable way. The approach of the transmission electron microscope with electron lenses of electrostatic hole electrodes was later pursued by outstanding experimentalists in other places and led to considerable initial success. It had, however, to be abandoned because the electrostatic lens was for physical reasons inferior to the magnetic electron lens.

#### *E. The invention of the electron microscope*

After obtaining my Degree (early 1931), the economic situation had become very difficult in Germany and it seemed not possible to find a satisfactory position at a University or in industry. Therefore I was glad that I could at least continue my unpaid position as doctorand in the high-voltage institute. After having shown in my Studienarbeit of 1929 that sharp and magnified images of electron-irradiated hole apertures could be obtained with the short coil, I was now interested in finding out if such images - as in light optics - could be further magnified by arranging a second imaging stage behind the first stage. Such an apparatus with two short coils was easily put together (Fig. 2) and in April 1931 I obtained the definite proof that it was possible (Fig. 3). This apparatus is justifiably regarded today as the first electron microscope even though its total magnification of  $3.6 \times 4.8 = 14.4$  was extremely modest.

The first proof had thus been given that-apart from light and glass lenses - images of irradiated specimens could be obtained also by electron beams and magnetic fields, and this in even more than one imaging stage. But what was the use of such images if even grids of platinum or molybdenum were burnt to cinders at the irradiation level needed for a magnification of only 17.4 x. Not wishing to be accused of showmanship, Max Knoll and I agreed to avoid the term *electron microscope* in the lecture Knoll gave in June 1931 on the progress in the construction of cathode ray oscillographs where he also, for the first time, described in detail my electron-optical investigations [9, 10]. But, of course, our thoughts were circling around a more efficient microscope. The resolution limit of the light microscope due to the length of the light wave which had been recognized 50 years before by Ernst Abbe and others could, because of lack of light, not be important at such magnifications. Knoll and I simply hoped for extremely low dimensions of the electrons. As engineers we did not know yet the thesis of the "material wave" of the French physicist de Broglie [11] that had been put forward several years earlier (1925). Even physicists only reluctantly accepted this new thesis. When I first heard of it in summer 1931, I was very much disappointed that now even at the electron microscope the resolution should be limited again by a wavelength (of the "Materiestrahlung"). I was immediately heartened, though, when with the aid of the de Broglie equation I became satisfied that these waves must be around five orders of

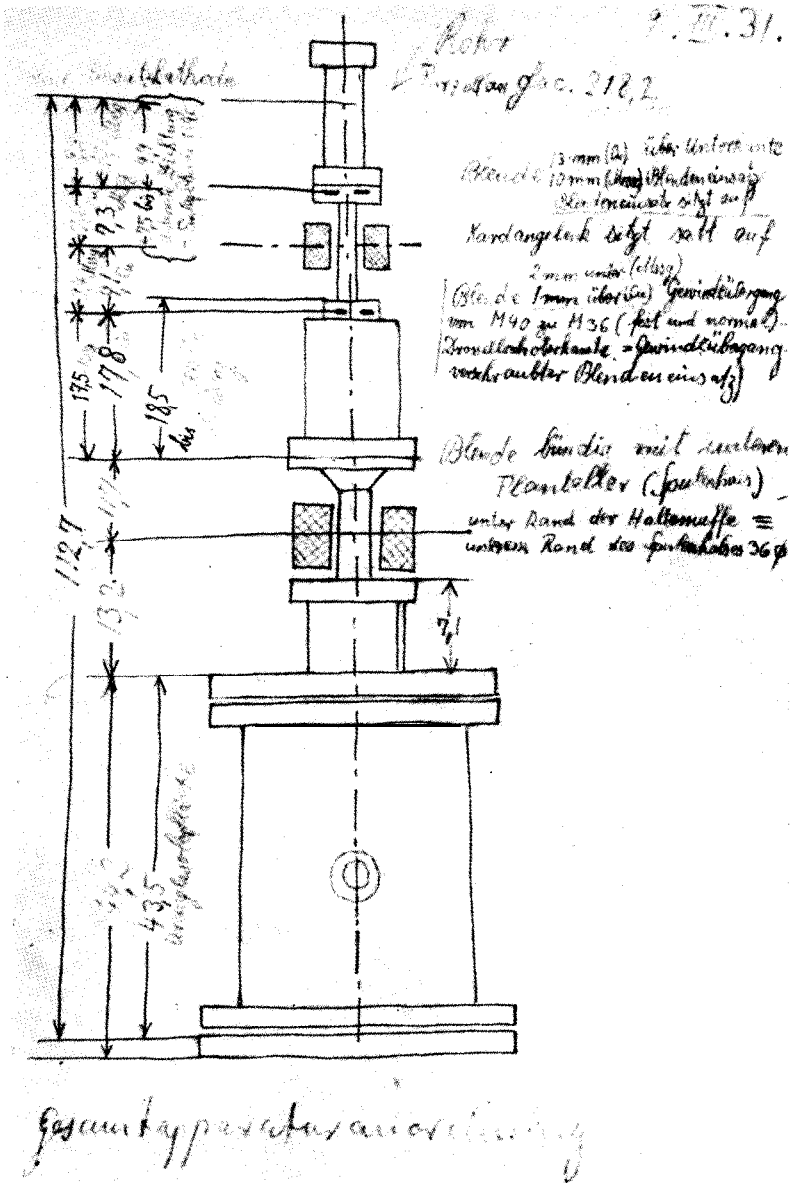

Fig. 2: Sketch by the author (9 March 1931) of the cathode ray tube for testing one-stage and two-stage electron-optical imaging by means of two magnetic electron lenses (electron microscope) [8].

magnitude shorter in length than light waves. Thus, there was no reason to abandon the aim of electron microscopy surpassing the resolution of light microscopy.

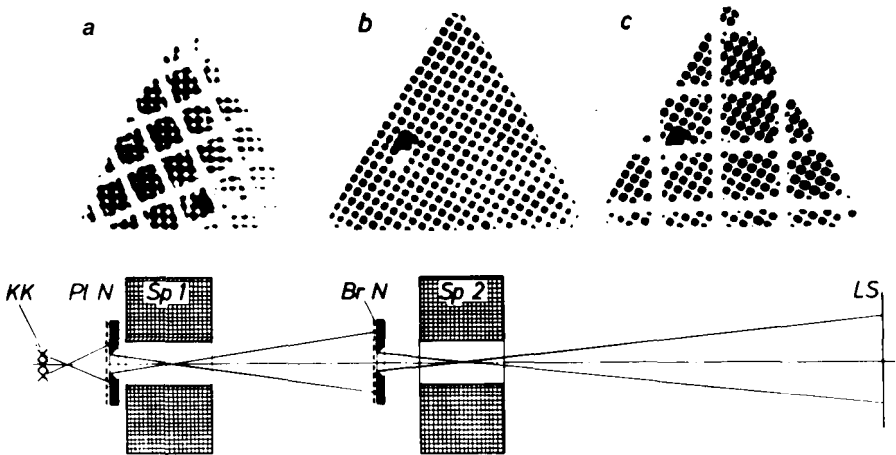

Fig. 3: First experimental proof (7 April 1931) that specimens (aperture grids) irradiated by electrons can be imaged in magnified form not only in one but also in more than one stage by means of (magnetic) electron lenses.

( $U = 50$  kV). [8].

- a) one-stage image of the platinum grid in front of coil 1 by coil 1;  $M = 13 \times$
  - b) one-stage image of the bronze grid in front of coil 2 by coil 2;  $M = 4.8 \times$
  - c) two-stage image of the platinum grid in front of coil 1 by coil 2;  $M = 17.4 \times$  together with the one-stage image of the bronze grid in front of coil 2 by coil 2;  $M = 4.8 \times$
- kk Cold cathode; Pt N Platinum grid; Sp 1 coil 1;  
Br N Bronze grid; Sp 2 coil 2; LS Fluorescent screen

In 1932 Knoll and I dared to make a prognosis of the resolution limit of the electron microscope [12]. Assuming that the equation for the resolution limit of the light microscope is valid also for the material wave of the electrons, we replaced the wave length of the light by the wave length of electrons at an accelerating voltage of 75 kV and inserted into the Abbe relation the imaging aperture of  $2 \times 10^{-2}$  rad which is what we had used previously. This imaging aperture is still used today. Thereby, that early we came up with a resolution limit of  $2.2 \text{ \AA} = 2.2 \times 10^{-10} \text{ m}$ , a value that was in fact obtained 40 years later.

Of course, at that time our approach was not taken seriously by most of the experts. They rather regarded it as a pipe-dream. I myself felt that it would be very hard to overcome the efforts still needed - mainly the problem of specimen heating. In April 1932, M. Knoll had taken up a position with Telefunken (Berlin) involving developmental work in the field of television.

In contrast to many biologists and medical scientists, my brother Helmut, who had almost completed his medical studies, believed in considerable progress for these disciplines should we be successful. With his confidence in a successful outcome he encouraged me to overcome the expected difficulties. In a next step I had to show that it was possible to obtain sufficiently high magnifications to prove a better-than-light-microscope resolution. To this effect a coil shape had to be developed whose magnetic field was compressed to a length that small of the coil axis to allow short focal lengths as are needed for



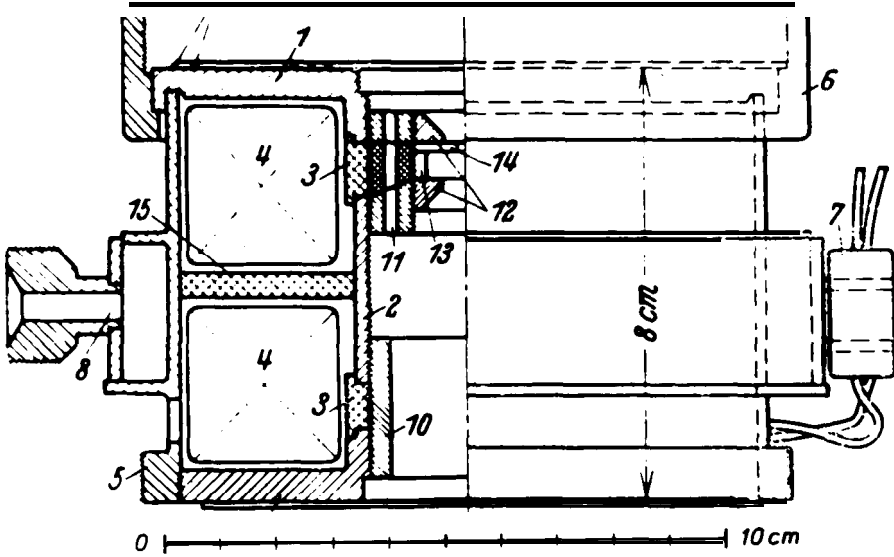

Fig. 4: Cross-section of the first polepiece lens [4, 15].

highly magnified images in not too great a distance behind the coil. The technical solution for this I had already given in my Studienarbeit of 1929 with the iron-clad coil. In 1932 I applied-together with my friend and co-doctorand Bodo v. Borries - for a patent on the optimization of this solution [13], the "Polschuhlinse", which is used in all magnetic electron microscopes today. Its realization and the measuring of the focal lengths which could be verified with it were subject of my thesis [14]. It was completed in August 1933, and in my measurements I obtained focal lengths of 3 mm for electron rays of 75 kV acceleration (Fig. 4). Of course, now with these lenses I immediately wanted to design a second electron microscope with much higher resolving power. To carry out this task I obtained by the good offices of Max v. Laue for the second half year of 1933 a stipend of Reichsmark 100 per month from the Notgemeinschaft der Deutschen Wissenschaft to defray running costs and personal expenses. Since I had completed the new instrument by the end of November (Fig. 5), I felt I ought to return my payment for December. To my great joy, however, I was allowed to keep the money "as an exception". Nevertheless, this certainly was the cheapest electron microscope ever paid for by a German organization for the promotion of science.

For reasons explained in the beginning of the next chapter, I accepted a position in industry on 1 December 1933. Therefore I could only make a few images with this instrument which magnified  $12000 \times$  [15], but I noticed a decisive fact which gave me hope for the future: Even very thin specimens yielded sufficient contrast, yet no longer by absorption but solely by diffraction of the electrons, whereby - as is known - the specimens are heated up considerably less.

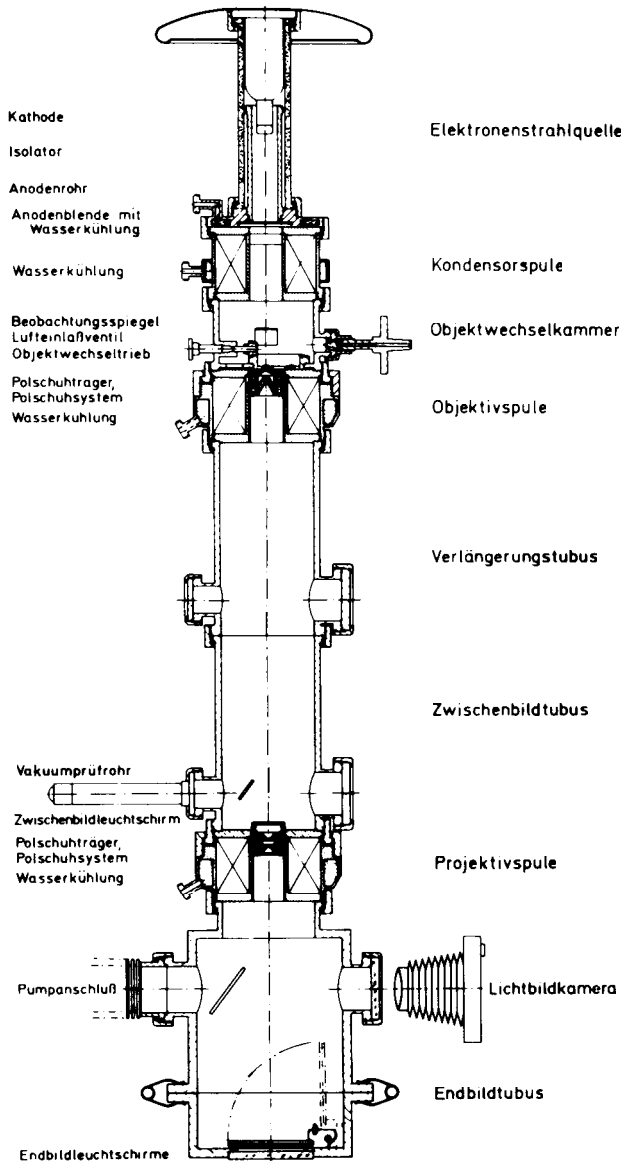

Fig. 5: First (two-stage) electron microscope magnifying higher than the light microscope. Cross-section of the microscope column (Re-drawn 1976) [15].

*F: How the industrial production of electron microscopes came to be*

I also realized, however, that the further development of a practically useful instrument with better resolution would require a longer period of time and enormous costs. In view of the results achieved there was little hope of obtaining financial support from any side for the time being. I was prepared for a longer dry spell and decided to approach the goal of a commercial instrument later, together with Bodo v. Borries and my brother Helmut. Therefore, I

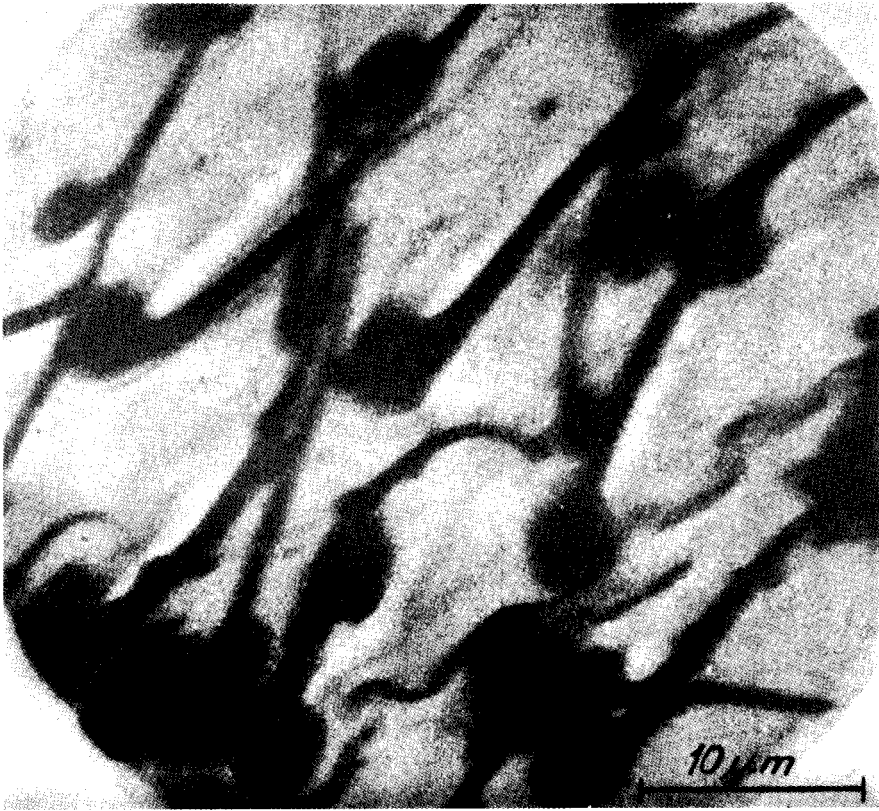

Fig. 6: Wing surface of the house fly.  
(First internal photography,  $U = 60$  kV,  $M_{\text{eff}} = 2200$ )  
(Driest, E., and Müller, H.O.: *Z. Wiss. Mikroskopie* 52, 53-57 (1935))

accepted a position with the Fernseh AG in Berlin-Zehlendorf where I was engaged in the development of Braun tubes for image pick-up and display tubes. In order to better coordinate our efforts to obtain financial support for the production of commercial electron microscopes, I convinced Bodo v. Borries to give up his position at the Rheinisch-Westfälische Elektrizitätswerke at Essen and return to Berlin. Here, he found a position at Siemens-Schuckert in 1934. We approached many governmental and industrial research facilities for financial help.

During this period, first electron micrographs appeared of biological specimens. Heinz Otto Müller (student in electrotechnical engineering) and Friedrich Krause (medical student) worked at the instrument I had built in 1933, and they published increasingly better results (Figs. 6 to 9). Unfortunately these two very gifted young scientists did not survive the II. World War.

At Brussels Ladislaus Marton had built his first horizontal microscope and obtained relatively low magnifications of biological specimens [17]. In 1936 he built a second instrument, this time with a vertical column [18].



Fig. 7: Diatoms *Amphipleura pellucida*.

( $U = 53 \text{ kV}$ ,  $M_a = 3500$ ,  $\delta'' = 130 \text{ nm}$ )

(F. Krause in: Busch, H., and Brüche, E.: Beiträger zur Elektronenoptik, 55-61, Verl. Joh. Ambrosius Barth, Leipzig 1937)



|----- 10  $\mu$ m -----|

*Fig. 8:* Bacteria (culture infusion), fixed with formalin and embedded in a supporting film stained with a heavy metal salt  
( $U = 73.5$  kV,  $M_s = 2000$ )  
(Krause, F.: *Naturwissenschaften* 25,817-825 (1937)).

In spite of these more recent publications, it took us three years to be successful in our quest for financial support through the professional assessment of Helmut Ruska's former clinical teacher, Professor Dr. Richard Siebeck, Director of the I. Medical Clinic of the Berlin Charité. I quote two paragraphs of his assessment of 2 October 1936 [19]:

"If these things were to be realised it hardly needs to be emphasised that the advances in the field of research into the causes of disease would be of immediate practical interest to the doctor. It would deeply affect real problems concerned to a large extent with diseases of growing clinical significance and thus of great importance for public health.

Should the possibilities of microscopical resolution exceed the assumed values by a factor of a hundred, the scientific consequences would be incalculable. What seems attainable now, I consider to be so important, and success seems to me so close, that I am ready and willing to advise on medical research work and to collaborate by making available the resources of my Institute".



Fig. 9.: Iron Whisker  
 ( $U = 79 \text{ kW}$ ,  $M_a = 3100$ )  
 (Beischer, D., and Krause, F.: *Naturwissenschaften* 25,  
 825-829 (1937)).

This expertise impressed Siemens in Berlin and Carl Zeiss in Jena, and they were both ready to further the development of industrial electron microscopes. We suggested the setting up of a common development facility in order to make use of the electrotechnical expertise of Siemens and the know-how in precision engineering of Zeiß, but unfortunately the suggestion was refused and so we decided in favour of Siemens. As first collaborators we secured Heinz Otto Müller for the practical development and Walter Glaser from Prag as theorist. We started in 1937, and in 1938 we had completed two prototypes with condenser and polepieces for objective and projective as well as airlocks for specimens and photoplates. The maximum magnification was  $30000 \times$  [20]. One of these instruments was immediately used for first biological investigations by Helmut Ruska and several medical collaborators. (H. Ruska was released from Professor Siebeck for our work at Siemens.) Unfortunately, for reasons of time I cannot give here a survey of this fruitful publication period.

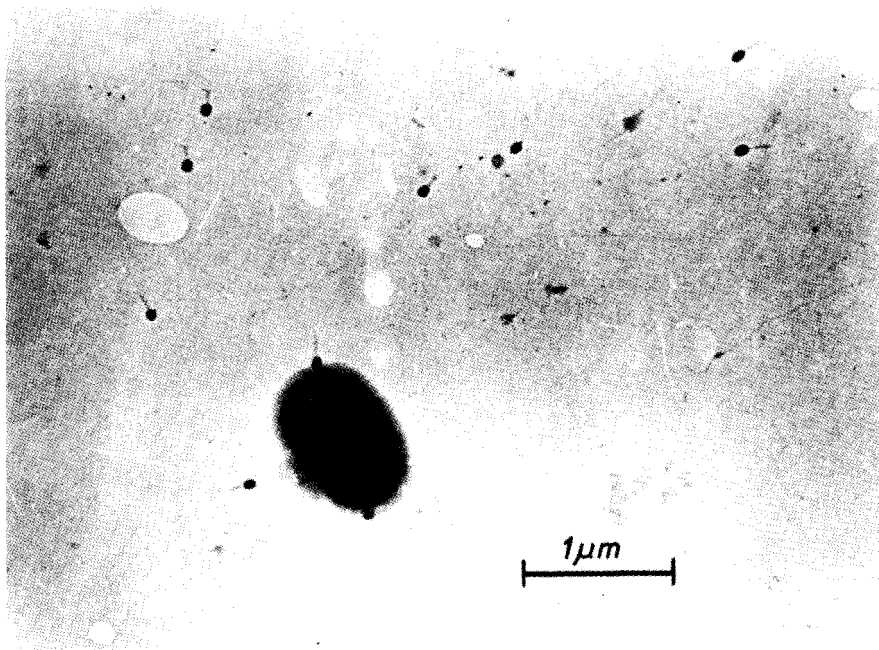

Fig. 10: Bacteriophages. (Ruska, H.: *Naturwissenschaften* 29, 367-368 (1941) and *Arch. Ges. Virusforsch* 2, 345-387 (1942).

In 1940, upon our proposal Siemens set up a guest laboratory, headed by Helmut Ruska, with four electron microscopes for visiting scientists. Helmut Ruska could show first images of bacteriophages in 1940. An image taken somewhat later (Fig. 10) clearly shows the shape of these tiny hostile bacteria. This laboratory was destroyed during an air raid in the autumn of 1944.

Very gradually now interest in electron microscopy was growing. A first sales success for Siemens has been achieved in 1938 when the chemical industry which was represented largely by IG Farbenindustrie placed orders for an instrument in each of their works in Hoechst, Leverkusen, Bitterfeld and Wolfen. The instrument was only planned at the time, however not yet built or even tested. By the end of 1939 the first serially produced Siemens instrument [21] had been delivered to Hoechst (Fig. 11). The instrument No 26 was, by the way, delivered to Professor Arne Tiselius in Uppsala in autumn 1943. By February 1945 more than 30 electron microscopes had been built in Berlin and delivered. Thus, now also independent representatives of various medical and biological disciplines could form their own opinions about the future prospects of electron microscopy. The choice of specimens was still limited though, since sufficiently thin sections were not yet available. The end of the war terminated the close cooperation with my brother and B. v. Borries.

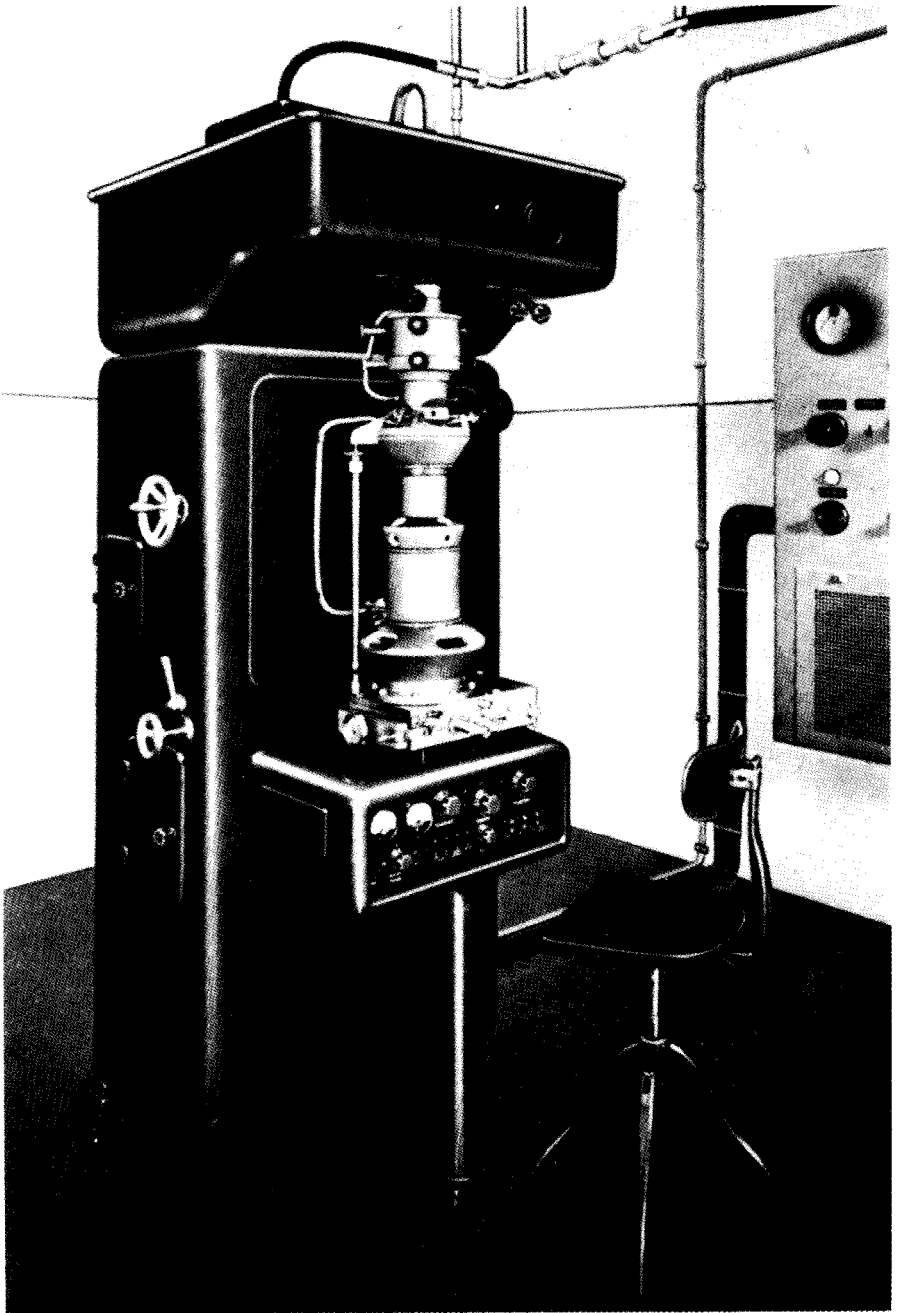

Fig. 11: The first serially produced electron microscope, by Siemens. General view [Z1]



*G. Development of electron microscopy after 1945*

Our laboratory had to be reconstructed completely. I could start working with mainly new coworkers as early as June 1945. In spite of difficult conditions in Berlin and Germany, newly developed electron microscopes [22] could be delivered by the end of 1949. In 1954 Siemens had regained its former leading position with the "Elmiskop" [23] (Fig. 12 and Fig. 13). This instrument had, for the first time, two condenser lenses allowing thermal protection of the specimen by irradiating only the small region that is required for the desired final magnification. Since now, for a final magnification of  $100\,000\times$  a specimen field of only  $1\ \mu\text{m}$  must be irradiated for an image of  $10\ \text{cm}$  diameter in contrast to earlier irradiation areas of about  $1\ \text{mm}$  diameter, the power of the electron beam converted into heat in the object can be reduced down to the millionth part. The specimens are heated up just to the extent that the heat power produced can be radiated into the entire region around the object. If the heat power is low, a lower temperature rise with respect to the environment results.

The new instrument was, however, a big disappointment at first when we realized that at this "small region radiation" the image of the specimen fields, which was now no longer hot, became so dark within seconds that all initially visible details disappeared. Investigations then showed that minor residual gases in the evacuated instrument, particularly hydrocarbons, condensed on the cold inner planes of the instrument, i.e. they now even condensed on the specimen itself. The image of the resulting C layer in the irradiated specimen field becomes darker with increasing thickness of the layer. Happily, also this hurdle could, after some time, be surmounted by relatively simple means: The entire environment of the specimen was cooled by liquid air so that the specimen was still markedly warmer than its environment, even without being heated up by the beam. Thus, the residual gases of hydrocarbons condensed on the low-cooled planes and no longer on the specimen.

Along with the successful solution of this problem, another difficulty, that of specimen thickness, had also surprisingly been overcome by newly developed "ultramicrotomes". Instead of the ground steel knives whose blades were not sufficiently smooth due to crystallization, glass fracture edges were used which had no crystalline unevenness. The usual mechanical translation of the material perpendicular to the knife is - because of mechanical backlash or even oil layers - not sufficiently precise for the desired very small displacements of  $\sim 10^{-5}\ \text{mm}$ . Smallest displacements free of flaws were obtained by thermal extension of a rod at whose ends the specimen to be cut was fastened. In order to keep the extremely thin sections smooth, they were dropped into an alcoholic solution immediately after being cut so that they remained entirely flat. Moreover, more suitable fixing agents had been found for the new cutting techniques. The development of these new ultramicrotomes considerably reduced the limitation in the choice of specimens for electron microscopy. For 25 years now, almost all disciplines furthered by light microscopy have also been able to benefit from electron microscopy.

During the last decades, electron microscopy has been advanced in many

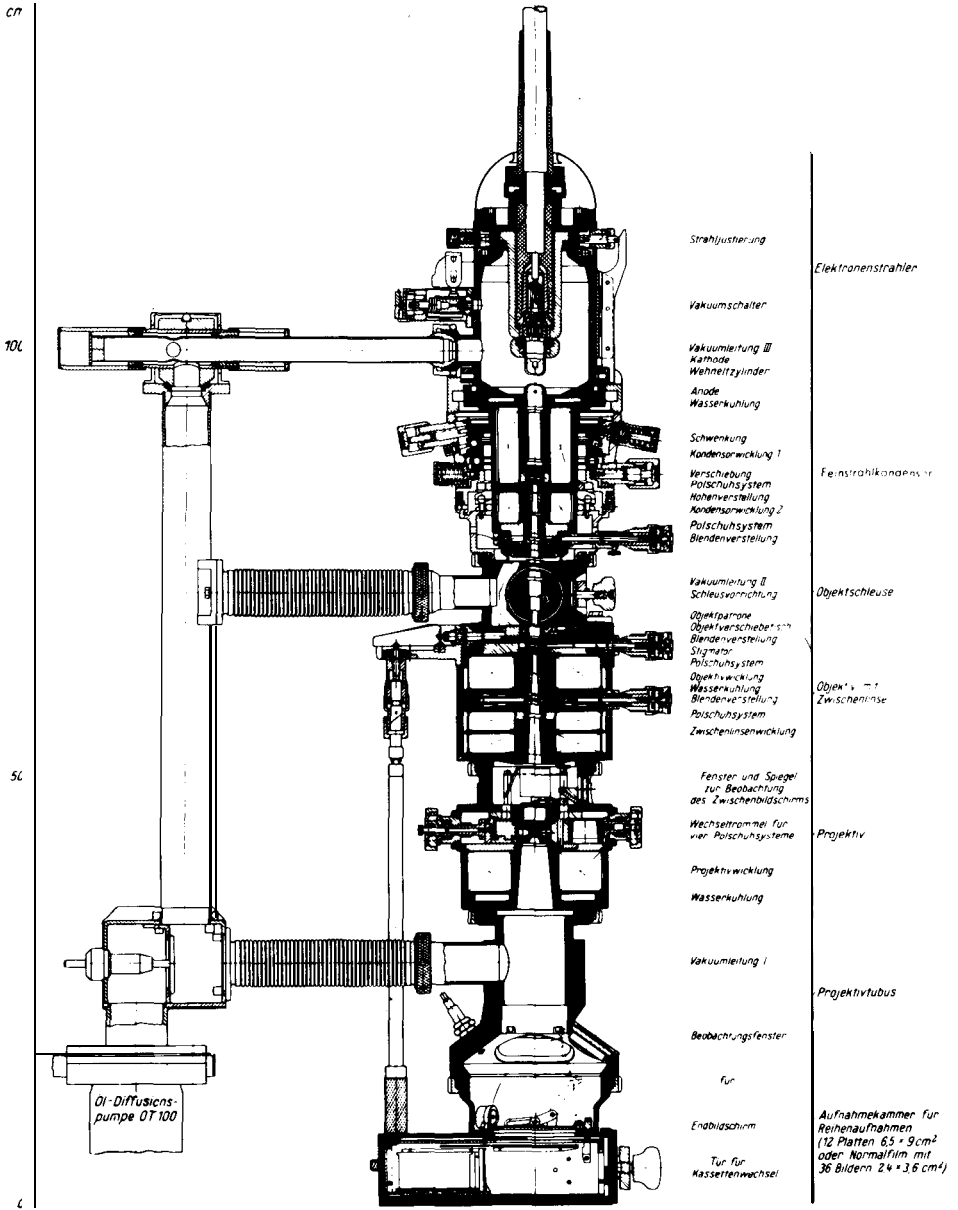

Fig. 12: The first serially produced 100 kV-Electron microscope with two condenser lenses for "small region radiation" by Siemens. (cross-section) [23].

countries by numerous leading scientists and engineers through new ideas and procedures. I can here only give a few examples: Fig. 14 shows a cross-section through an electron microscope with single-field condenser objective, the specimen being in the field maximum of a magnetic polepiece lens [24]. Thereby, the region of increasing magnetic field in front of the specimen behaves like a condenser of short focal length and the decreasing field region behind the

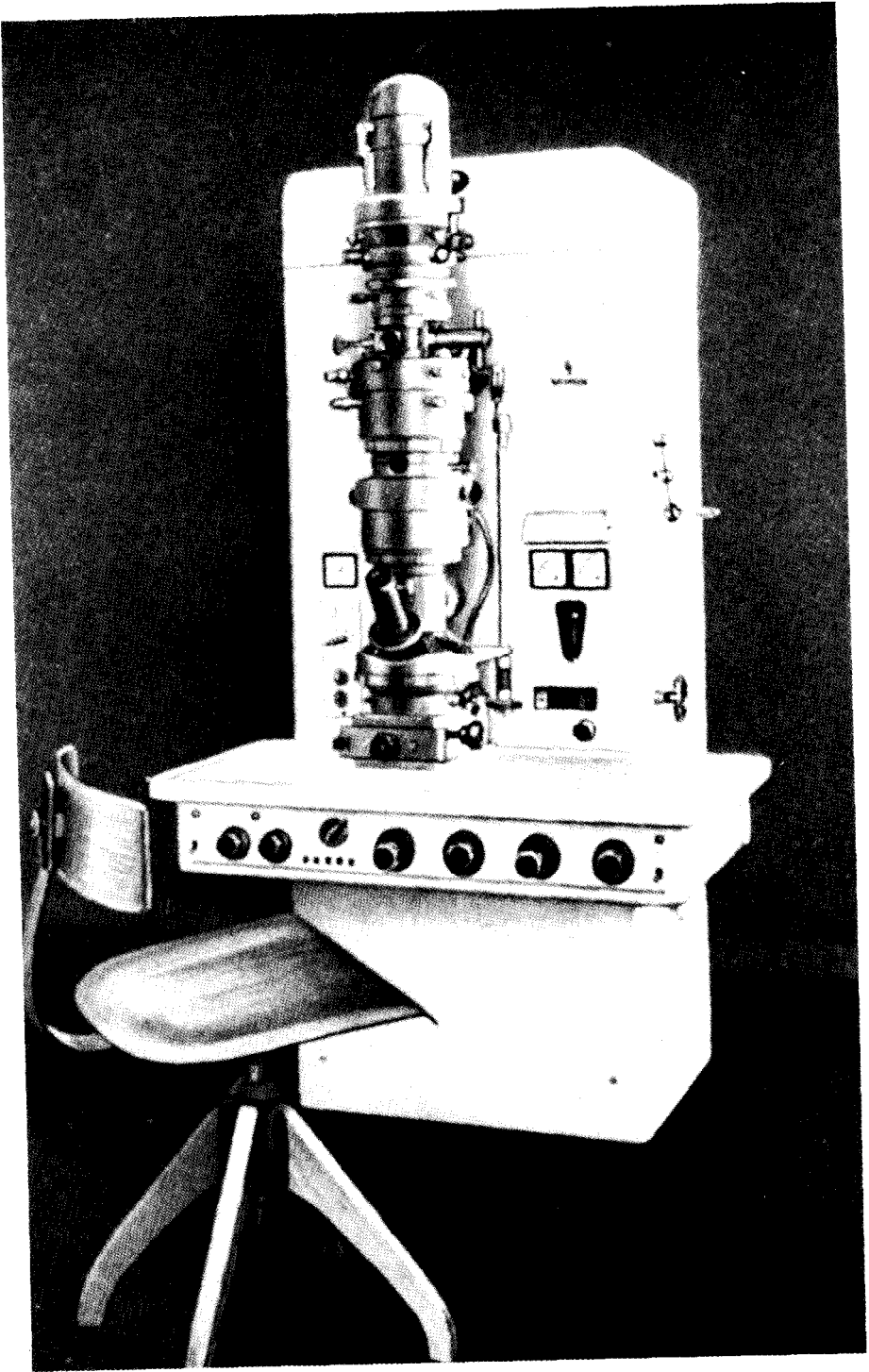

Fig. 13: Same instrument as in Fig. 12 (general view) [23]

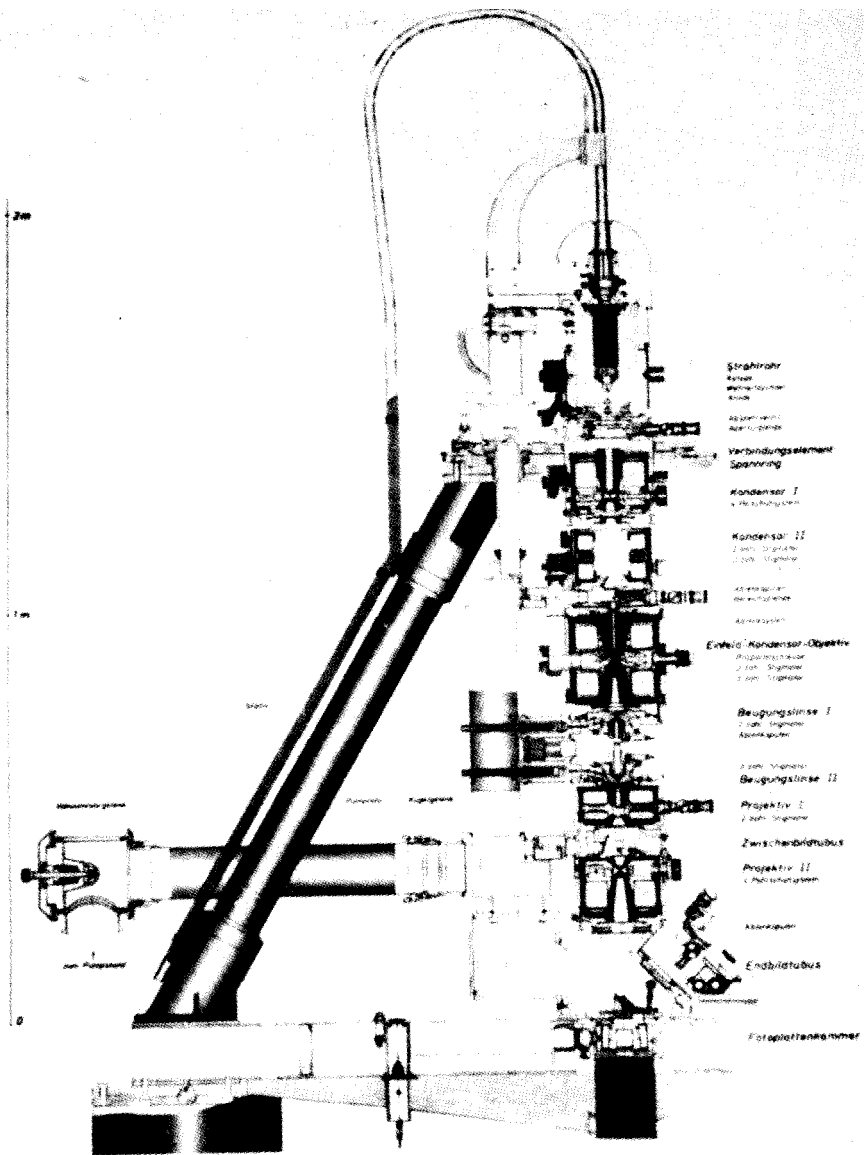

Fig. 14: Electron microscope with single-field condenser objective.

specimen as an objective of equal focal length. With this arrangement both lenses have a particularly small spherical aberration. Fig. 15 gives a view of the same instrument. Fig. 16 shows an image obtained with this instrument of a platelet of a gold crystal. One can clearly see lattice planes separated by a distance of  $1.4 \text{ \AA}$ . Two such instruments have been further developed in the Institute for Electron Microscopy, which had been set up for me in 1957 by the Max-Planck-Gesellschaft after I had left Siemens. Fig. 17 shows a 3 MV high-voltage instrument developed by Japan Electron Optics Laboratory Co. Ltd. With such instruments whose development was mainly promoted by Gaston

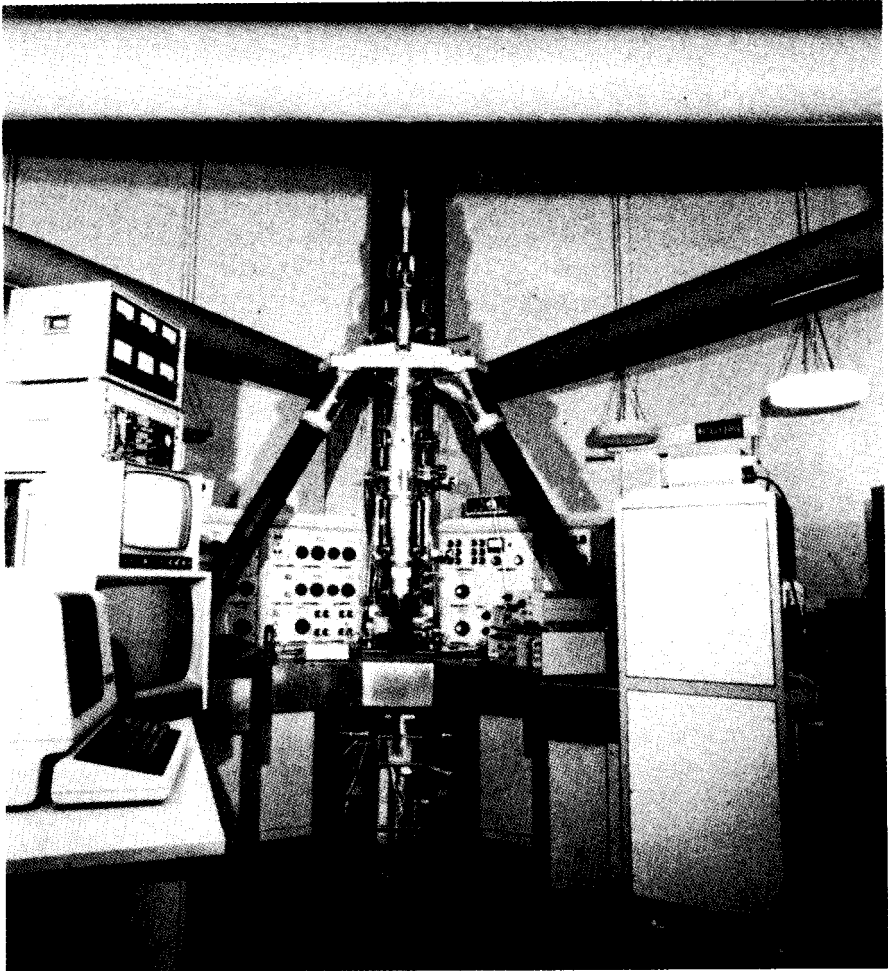

Fig. 15: Same instrument as in Fig. 14 (general view) [24].

Dupouy (1900- 1985), apart from extremely high costs, special problems occur in the stabilization of the acceleration voltage and with the protection of the operators against X rays. The aim of the development of these instruments was the investigation of thicker specimens, but now that the problem of stabilizing the high voltages has been overcome, also the resolution has been improved by the shorter material wave length of particularly highly accelerated electrons, so that thinner specimens can also be investigated.

For quite some time now, the cryotechnique - put forward mainly by Fernandez-Moran in the USA - has been of increasing importance. With this technique specimens cooled down to very low temperatures can be studied, because they are more resistant to higher electron doses, i.e. the mobility inside the specimen is very much reduced compared to room temperature. Thus, even after unavoidable ionization, the molecules keep their structure for a long time. In the last years it has been possible to image very beam-sensitive crystals in a cryomicroscope with a resolution of  $3.5 \text{ \AA}$  [25, 26] (Fig. 18) [27].

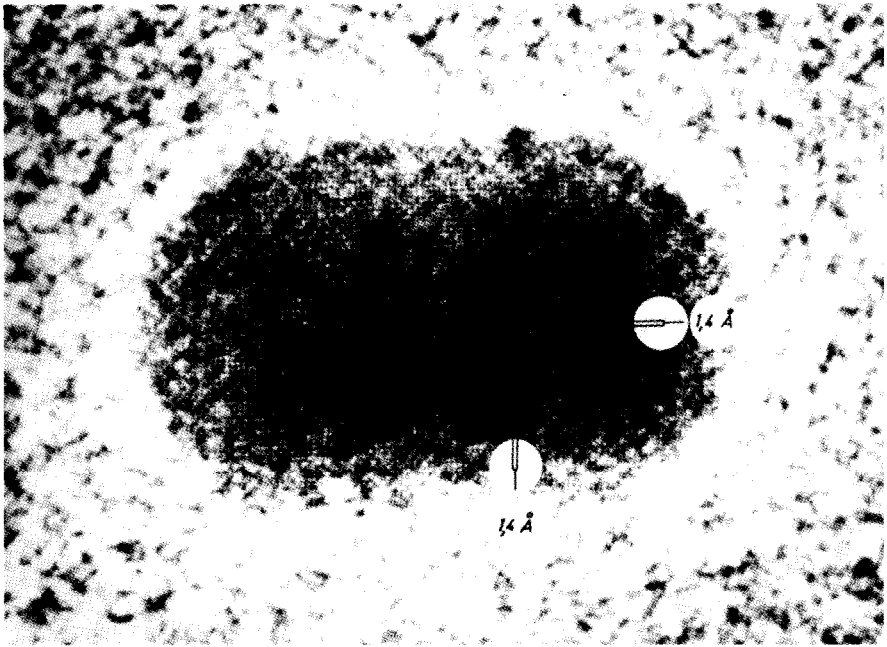

Fig. 16: Plate-like gold crystal, lattice planes with a separation of 0.14 nm, taken with axial illumination.

( $U = 100$  kV,  $M_s = 800000$ ); taken (1976) by K. Weiss and F. Zemlin with the 100 kV transmission electron microscope with single-field condenser objective at the Fritz-Haber-Institut of the Max-Planck-Gesellschaft.

The specimens were cooled down to  $-269^\circ\text{C}$ . Direct imaging with sufficient contrast is not possible because the specimen is destroyed at the beam dose needed for normal exposure. Therefore, many very low-dose images are recorded and averaged. Such a single image is very noisy but still contains sufficient periodical information. The evaluation procedure is the following: First, the microgram is digitized using the densitometer so that each image point is given a number which describes the optical density. The underexposed image of the whole crystal is divided like a checkerboard by the computer and then a large number - in our case 400 - of these image sub-regions is cross-correlated and summed up by the computer. The resulting image corresponds to a sufficiently exposed micrograph. On the left part in Fig. 18, the initial noisy image of a paraffin crystal is seen; the right side shows the averaged image. Each white point is the image of a paraffin molecule. The long paraffin molecules  $\text{C}_{44}\text{H}_{90}$  are vertical to the image plane. With this procedure electron micrographical images can be processed by the computer. It is even possible to image three-dimensional protein crystals with very high resolution [27]. The computer is a powerful tool in modern electron microscopy.

I cannot go into detail concerning the transmission electron microscopes with electrostatic lenses, the scanning electron microscopes which are widely used mainly for the study of surfaces as well as transparent specimens, the great

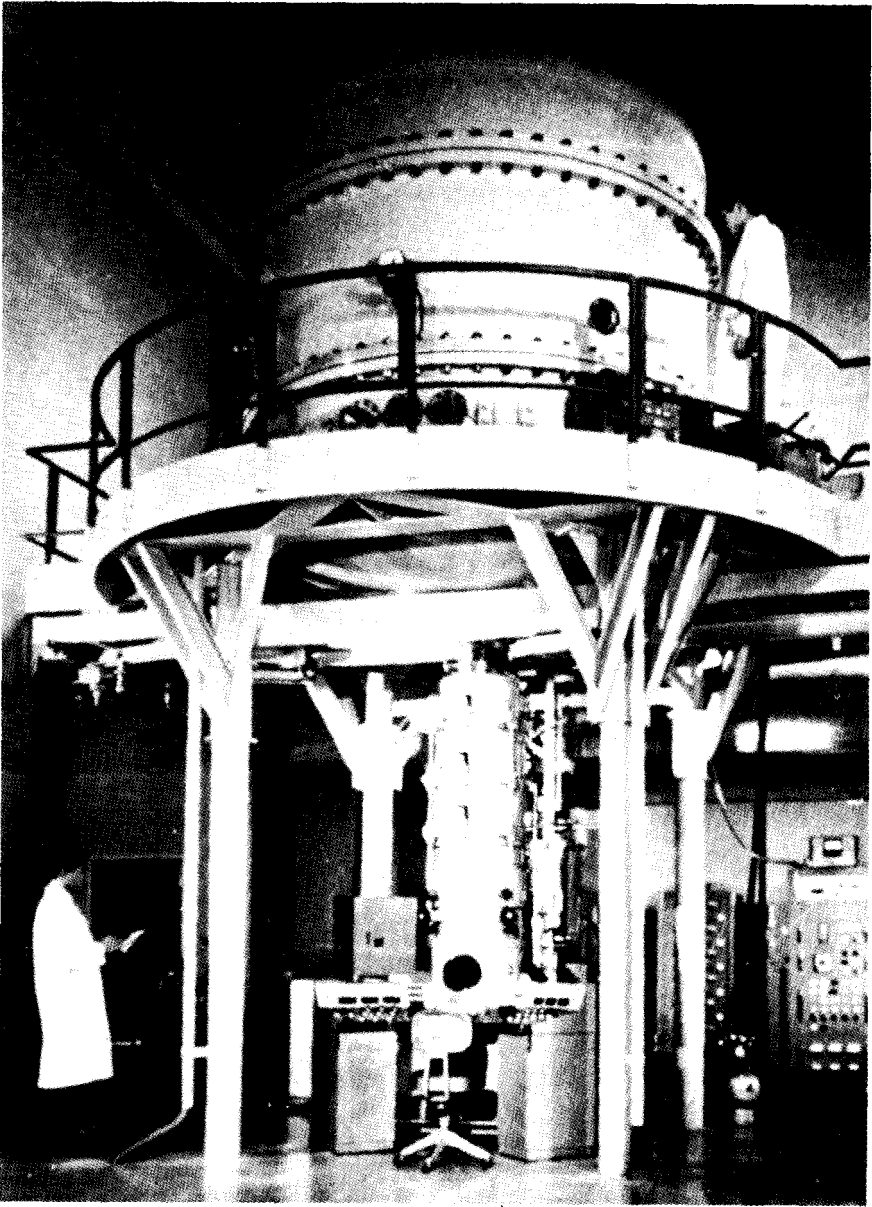

Fig. 17: 1 MV Electron Microscope (Japan Electron Optics Laboratory Co. Ltd.)

importance of various image processing methods carried out partly by the computer, the field-electron microscope and the ion microscope.

The development of the electron microscopy of today was mainly a battle against the undesired consequences of the same properties of electron rays which paved the way for sub-light-microscopical resolution. Thus, for instance, the short material wavelength-prerequisite for good resolution - is coupled with the undesired high electron energy which causes specimen damage. The

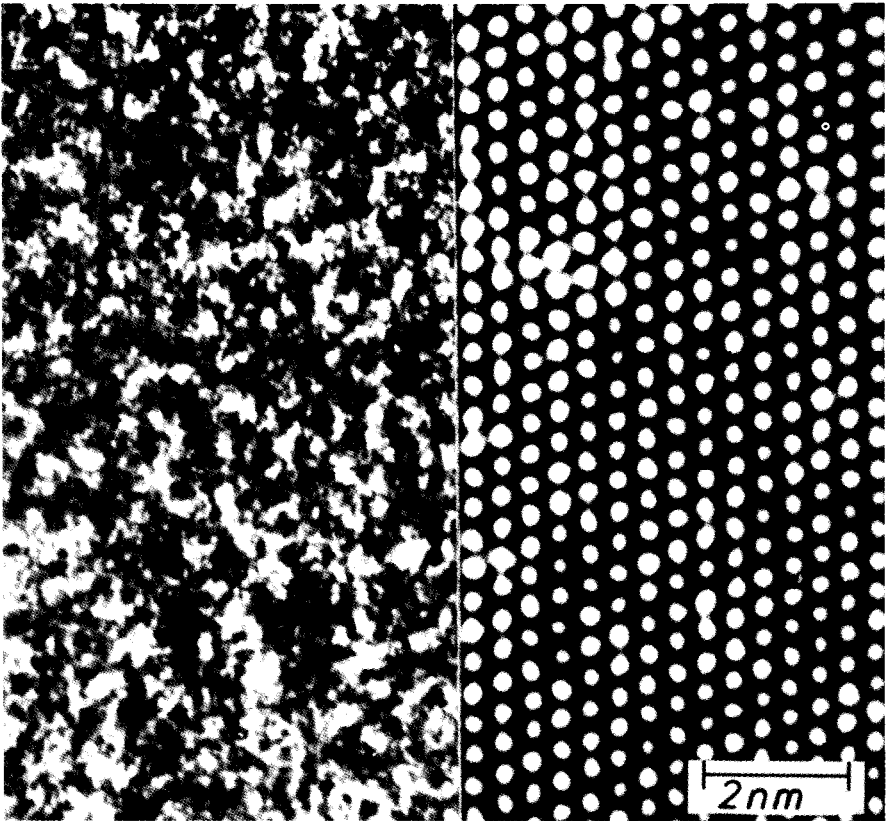

Fig. 18: Paraffin crystal (left: image taken with minimum dose, right: superposition of 400 sub-regions of the left image by means of the computer. [25].

deflectability in the magnetic field, a precondition for lens imaging, can also limit the resolution if the alternating magnetic fields in the environment of the microscope are not sufficiently shielded by the electron microscopy. We should not, therefore, blame those scientists today who did not believe in electron microscopy at its beginning. It is a miracle that by now the difficulties have been solved to an extent that so many scientific disciplines today can reap its benefits.



## REFERENCES

1. Rankin, R.: The cathode ray oscillograph. *The Electric Club J*, II, 620-631 (1905).
2. Hittorf, W.: Über die Elektrizitätsleitung der Gase, I. und II. (On the electrical conductivity of gases.) *Ann Physik. Chemie*, 16, 1-31 und 197-234 (1869), Münster, 9 Oct. 1868.
3. Busch, H.: Über die Wirkungsweise der Konzentrierungsspule bei der Braunschen Röhre. (On the mode of action of the concentrating coil in the Braun tube.) *Arch. Elektrotechnik* 18, 583-594 (1927), Jena, Physikalisches Institut, März 1927.
4. Ruska, E.: Über eine Berechnungsmethode des Kathodenstrahloszillographen auf Grund der experimentell gefundenen Abhängigkeit des Schreibfleckdurchmessers von der Stellung der Konzentrierspule. (On a method of designing a cathode ray oscillograph on the basis of the experimentally found dependence of the writing spot diameter on the position of the concentrating coil.) Carried out from 1 November 1928 in the High Voltage Laboratory of the Technische Hochschule Berlin (Director Prof. A. Matthias). Student Project thesis (117 pp.) submitted 10 May 1929.
5. Ruska, E., and Knoll, M.: Die magnetische Sammelspule für schnelle Elektronenstrahlen. (The magnetic concentrating coil for fast electron beams.) *Z. techn. Physik* 12, 389-400 and 448 (1931), submitted 18 April 1931.
6. Knoll, M.: Vorrichtung zur Konzentrierung des Elektronenstrahls eines Kathodenstrahloszillographen. (Device for concentrating the electron beam of a cathode ray oscillograph.) German Patent NO. 690809, patented on 10 November 1929, granted on 11 April 1940.
7. Ruska, E.: Untersuchung elektrostatischer Sammelvorrichtungen als Ersatz der magnetischen Konzentrierspulen bei Kathodenstrahl-Oszillographen. (Investigation of electrostatic concentrating devices as a substitute for the magnetic concentrating coils in cathode ray oscillographs.) Begun on 18 July 1930 in the High Voltage Laboratory of the Technological University of Berlin (Direktor Prof. Dr. A. Matthias) and submitted on 23 December 1930 as a Diploma Project (pp. 1-90).
8. Knoll, M. and Ruska, E.: Beitrag zur geometrischen Elektronenoptik I und II. (Contribution to geometrical electron optics.) *Ann. Physik* 12, 607-640 and 641-661 (1932), submitted 10 September 1931.
9. Knoll, M.: Berechnungsgrundlagen und neuere Ausführungsformen des Kathodenstrahloszillographen. (The basis of design and new forms of construction of the cathode ray oscillograph.) Manuscript of a lecture in the Cranz-Colloquium at the Technological University of Berlin on 4 June 1931, pp. 1-26.
10. Ernst Ruska: "The Early Development of Electron Lenses and Electron Microscopy", S. Hirzel Verlag Stuttgart (1980), see pp. 113-116.
11. De Broglie, L.: Recherches sur la théorie des quanta. (Researches on the theory of quanta.) These, Paris: Masson & Cie. 1924. *Ann. de Physiques* 3, 22- 128 (1925).
12. Knoll, M., and Ruska, E.: Das Elektronenmikroskop. (The electron microscope.) *Z. Physik* 78, 318-339 (1932), submitted 16 June 1932.
13. v. Borries, B., and Ruska, E.: Magnetische Sammellinse kurzer Feldlänge. (Magnetic converging lens of short field length.) German Patent No. 680284, patented on 17 March 1932; Patent granted on 3 August 1939.
14. Ruska, E.: Über ein magnetisches Objektiv für das Elektronenmikroskop. (On a magnetic objective lens for the electron microscope.) Dissertation of the Technological University of Berlin, submitted 31 August 1933. *Z. Physik* 89, 90-128 (1934), submitted 5 March 1934.
15. Ruska, E.: Über Fortschritte im Bau und in der Leistung des magnetischen Elektronenmikroskops. (On progress in the construction and performance of the magnetic electron microscope.) *Z. Physik* 87, 580-602 (1934), submitted 12 Dec. 1933.
16. see 10), pp. 120-122.
17. Marton, L.: La microscope électronique des objets biologiques. (Electron microscopy of biological objects.) *Acad. roy. de Belg. Bull de la Cl. des Sci., Ser. 5*, 20, 439-446 (1934), Université libre de Bruxelles, Mai 1934.

18. Marton, L.: Le microscope électronique. (The electron microscope.) *Rev. de Microbiol. appl.* 2, 117-124 (1936).
19. see 10), pp. 123-124.
20. Borries, B.v., and Ruska, E.: Vorläufige Mitteilung über Fortschritte im Bau und in der Leistung des Übermikroskops. (Preliminary communication on advances in the construction and performance of the Ultramicroscope.) *Wiss. Veröff. a.d. Siemens-Werken* 17, 99-106 (1938), submitted 29 Feb. 1938.
21. Borries, B.v., and Ruska, E.: Ein Übermikroskop für Forschungsindustrie. (An Ultramicroscope for industrial research.) *Naturwissenschaften* 27, 577-582 (1939), submitted 24 June 1939.
22. Ruska, E.: Über neue magnetische Durchstrahlungs-Elektronenmikroskope im Strahlspannungsbereich von 40...220 kV, Teil I. (On new magnetic transmission-electron microscopes for beam voltages between 40 and 200 kV.) *Kolloid-Zeitschrift* 116, 103- 120 (1950), submitted 15 Dec. 1949.
23. Ruska, E., and O. Wolff: Ein hochauflösendes 100-kV-Elektronenmikroskop mit Kleinfelddurchstrahlung (A high-resolution transmission electron microscope (100 kV) with small-area illumination.) *Zeitschrift für wissenschaftl. Mikroskopie und mikroskopische Technik* 62, 466-509 (1956), submitted 19 July 1955.
24. Riecke, W.D., and Ruska, E.: A 100 kV transmission electron microscope with single-field condenser objective. VI. Int. Congress for Electron Microscopy, Kyoto, Japan, I, 19-20 (1966).
25. Zemlin, F., Reuber, E., Beckmann, E., Zeitler, E. and Dorset, D.L.: Molecular Resolution Electron Micrographs of Monolamellar Paraffin Crystals. *Science* 229, 461-462 (1985).
26. Dietrich, I., Fox, F., Knappek, E., Lefranc, G., Nachtrieb, K., Weyl, R. and Zerbst, H.: Improvements in electron microscopy by application of superconductivity, *Ultramicroscopy* 2, 241-249 (197 1).
27. Henderson, R., and Unwin, P.N.T.: Three-dimensional model of purple membrane obtained by electron microscopy, *Nature* 257, 28-32 (1975).