

MARIA GOEPPERT MAYER

The shell model

Nobel Lecture, December 12, 1963

1. Models

There are essentially two ways in which physicists at present seek to obtain a consistent picture of atomic nucleus. The first, the basic approach, is to study the elementary particles, their properties and mutual interaction. Thus one hopes to obtain a knowledge of the nuclear forces.

If the forces are known, one should in principle be able to calculate deductively the properties of individual complex nuclei. Only after this has been accomplished can one say that one completely understands nuclear structures.

Considerable progress in this direction has been made in the last few years. The work by Brueckner¹, Bethe² and others has developed ways of handling the many-body problem. But our knowledge of the nuclear forces is still far from complete.

The other approach is that of the experimentalist and consists in obtaining by direct experimentation as many data as possible for individual nuclei. One hopes in this way to find regularities and correlations which give a clue to the structure of the nucleus. There are many nuclear models, but I shall speak only of one and leave the others to the next lecture by Professor Jensen.

The shell model, although proposed by theoreticians, really corresponds to the experimentalist's approach. It was born from a thorough study of the experimental data, plotting them in different ways and looking for interconnections. This was done on both sides of the Atlantic ocean, and on both sides one found that the data show a remarkable pattern. This pattern emerges if one plots properties against either the number of neutrons, or the number of protons in the nuclei, rather than against the mass number.

2. Magic numbers

One of the main nuclear features which led to the development of the shell structure is the existence of what are usually called the magic numbers. That

such numbers exist was first remarked by Elsassers³ in 1933. What makes a number magic is that a configuration of a magic number of neutrons, or of protons, is unusually stable whatever the associated number of the other nucleons. When Teller and I worked on a paper on the origin of elements, I stumbled over the magic numbers. We found that there were a few nuclei which had a greater isotopic as well as cosmic abundance than our theory or any other reasonable continuum theory could possibly explain. Then I found that those nuclei had something in common: they either had 82 neutrons, whatever the associated proton number, or 50 neutrons. Eighty-two and fifty are « magic » numbers. That nuclei of this type are unusually abundant indicates that the excess stability must have played a part in the process of the creation of elements.

My attention was then called to Elsassers' papers written in 1933. In the year 1948 much more was known about properties of nuclei than was available to Elsassers. The magic numbers not only stood up in the new data, but they appeared more clearly than before, in all kinds of nuclear processes. It was no longer possible to consider them as due to purely accidental coincidences.

The magic numbers, as we know them now are :

$$2, 8, 20, 28, 50, 82, 126$$

and most importantly, they are the same for neutrons and protons. Fig. 1 shows the magic numbers and below them the stable nuclei containing magic number of protons or of neutrons.

Sn, $Z=50$ is the element with the largest number of stable isotopes, namely 11. There are 6 stable nuclei with 50 neutrons, and 7 with 82 neutrons, whereas normally there are only 2 or 3 nuclei with the same number of neutrons.

It has long been known that helium, with two neutrons and two protons, is very tightly bound. An extra nucleon cannot be attached to the helium core, that is ${}^5\text{Li}$ and ${}^5\text{He}$ do not exist. The number 8 is encountered at ${}^{16}_8\text{O}_8$. It takes an unusual amount of energy to remove a neutron from this nucleus. On the other hand, the ninth, the extra neutron beyond the 8-8 shell, in ${}^{17}_8\text{O}_8$, is very weakly bound.

For nuclei heavier than ${}^{40}\text{Ca}$ the number of protons is less than that of neutrons and only then does it become clear that the stability is connected with the neutron number or the proton number, and not with the total number of both.

Let me show just two examples. The first one is taken from the work of Süss and Jensen⁷, and is derived from the energy changes in α decay. Fig. 2

shows the energy difference between pairs of isobaric nuclides with neutron excess 3 and 1, with the common mass number as abscissa. The light nuclides, for which the energy difference is positive decay by β^- emission to the nuclides with $N-Z=1$. For the heavier nuclides, the neutron excess of 3 is the stable isobar, the energy is negative.

Magic number nuclides							
Number of protons	2	8	20	28	50	82	126
	⁴ He	¹⁶ O	⁴⁰ Ca	⁵⁸ Ni	¹¹² Sn	²⁰⁴ Pb	
		¹⁷ O	⁴² Ca	⁶⁰ Ni	¹¹⁴ Sn	²⁰⁶ Pb	
		¹⁸ O	⁴³ Ca	⁶¹ Ni	¹¹⁵ Sn	²⁰⁷ Pb	
			⁴⁴ Ca	⁶² Ni	¹¹⁶ Sn	²⁰⁸ Pb	
			⁴⁶ Ca	⁶⁴ Ni	¹¹⁷ Sn		
			⁴⁸ Ca		¹¹⁸ Sn		
					¹¹⁹ Sn		
					¹²⁰ Sn		
					¹²² Sn		
					¹²⁴ Sn		
Number of neutrons	2	8	20	28	50	82	126
	⁴ He	¹⁵ N	³⁶ S	⁴⁸ Ca	⁸⁶ Kr	¹³⁶ Xe	²⁰⁸ Pb
		¹⁶ O	³⁷ Cl	⁵⁰ Ti	⁸⁷ Rb	¹³⁸ Ba	²⁰⁹ Bi
			³⁸ A	⁵¹ V	⁸⁸ Sr	¹³⁹ La	
			³⁹ K	⁵² Cr	⁸⁹ Y	¹⁴⁰ Ce	
			⁴⁰ Ca	⁵⁴ Fe	⁹⁰ Zr	¹⁴¹ Pr	
					⁹² Mo	¹⁴² Nd	
						¹⁴⁴ Sm	

Fig. 1. The magic numbers.

One would expect to find a smooth curve, sloping downward. Except for one point it is indeed so. This point is ³⁹A with 21 neutrons and 18 protons. A smooth interpolation of the curve would predict ³⁹A is stable, and that its isobar ³⁹K is unstable against β^+ emission. However, ³⁹A is unstable against β^- emission by about 0.5 MeV. The explanation of this anomaly is the low binding energy of the 21st neutron in ³⁹A, while the 19th proton into which it is transformed has the higher binding energy of the proton shell which closes at 20. That the energies drop again sharply is due to the fact that now $Z=20$ is involved.

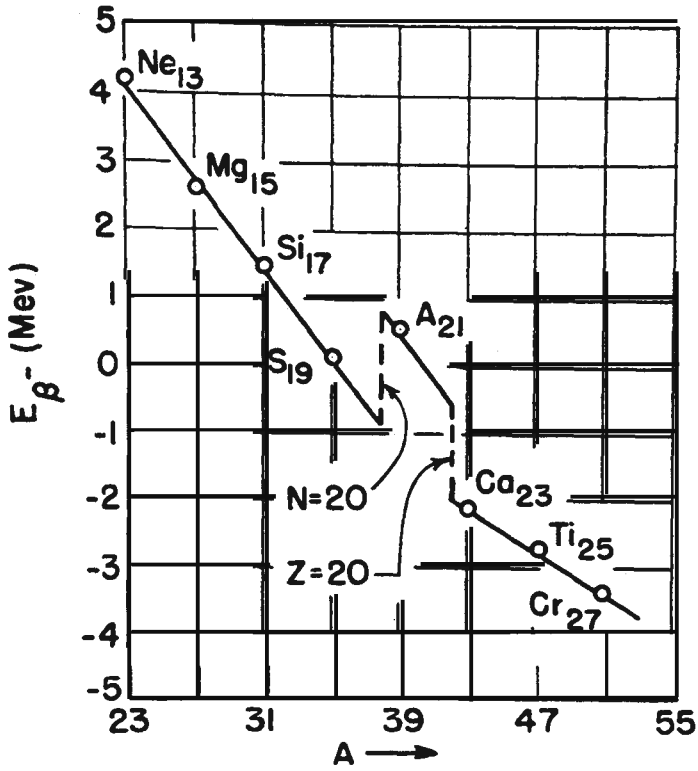

Fig. 2. Beta decay energies in the neighborhood of $N = 20$.

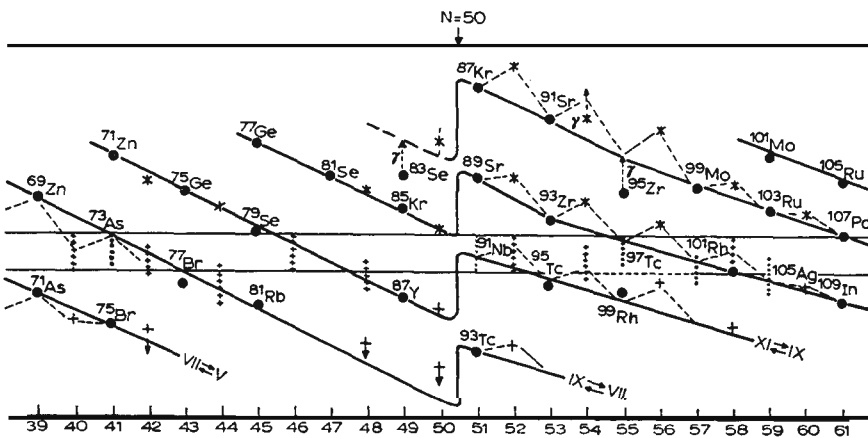

Fig. 3. Beta decay energies in the neighborhood of $N = 50$.

These types of discontinuity occur at all magic numbers. Fig. 3 shows it at the magic number $N=50$, where it occurs for various numbers of the neutron excess.

The other example is that of the highest magic number 126, which occurs only for neutrons, and which was noticed long ago. Again, the prediction is that it would be easy to remove the 127th or 128th neutron, but that it takes a considerable amount of energy to remove the 126th or 125th neutron, whatever the associated proton number. Fortunately, this is the region in which α -decay occurs, in which two neutrons are lost by the nucleus, along with two protons. And the prediction is simply born out by the facts.

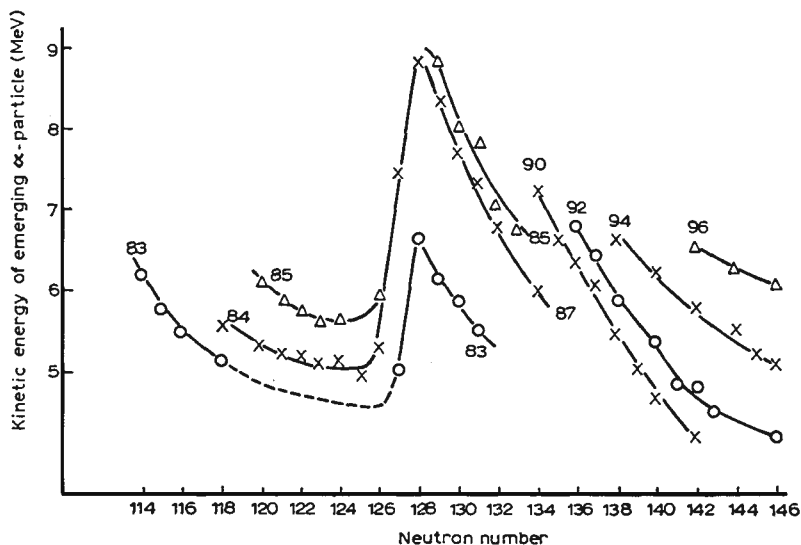

Fig. 4. Energy release in alpha decays.

Fig.4 (after Seaborg and Perlman) shows the experimental data of the kinetic energy of the emerging α -particle, with the number of neutrons as abscissas. Isotopes of the same elements are connected by lines. The trend of the curves for the neutron-rich nuclei is easy to understand. But for all elements the energy reaches its peak at 128 neutrons, and then drops sharply when the 126th and the 125th neutron is removed from the nucleus.

From those and similar data one can estimate that the discontinuity of the binding energy at the magic numbers is about 1.5 to 2 MeV.

3. *The atomic analogue*

The strong binding of a magic number of nucleons and weak binding for one more, immediately brings to mind a similar, only relatively much stronger effect which occurs in the electronic structure of atoms. The energy required to remove an electron from an atom is measured by the ionization potential. The closed electron shells occur in the noble gas atoms, which have a very high ionization potential. The atoms with atomic number larger by one unit, the alkali, have a very low ionization potential. For instance, for argon with atomic number 18 and 18 electrons, the energy to remove one electron is 15.69 eV, whereas the energy to remove the 19th electron from potassium is only 4.32 eV. That is, the binding energy of the last electron in argon is about three and a half times that in potassium. In the nuclear cases, the change in binding energy across a magic number is only two MeV out of about an average value of six, which is only about thirty to forty per cent. Yet the experimental facts leading to magic numbers were sufficiently marked and they could hardly arise from accident. It seemed to be worthwhile to attempt to explain them in the same way as the noble gases. Indeed one might try to copy the essential features of the atomic structure for nuclear structure.

The simplest atom is hydrogen, in which one electron is subjected to the spherically symmetrical attraction of one proton. The quantum mechanical levels are characterized by two numbers, of which one, n , is called the principal quantum number. The other one, l , determines the angular momentum. By accident, due to the fact that the potential is proportional to the reciprocal of the distance, the energy depends only, or almost only, on the principal quantum number n .

Classically, in a field of spherical symmetry the angular momentum is a constant of the motion. In quantum mechanics, the orbital angular momentum is quantized, so that its magnitude in units of Planck's constant \hbar is an integral value l . A level of given l contains $2l+1$ discrete states of different orientation in space, characterized by an integer m_l with $-l \leq m_l \leq l$. These numbers give the projection of the angular momentum on some axis in space. The states of given l and different values of m_l always have the same energy in any potential of spherical symmetry, even with potentials other than r^{-1} .

It is customary, to designate the levels of different l by letters in the following way:

$$\begin{array}{cccccc}
 l=0 & 1 & 2 & 3 & 4 & 5 \\
 & s & p & d & f & g & h
 \end{array}$$

Finally, the electrons have an intrinsic spin of $\frac{1}{2}$ about their own axes which can only have two directions in space. The direction of the spin can be described by a quantum number m_s , with $m_s = +\frac{1}{2}$ for spin « up » and $m_s = -\frac{1}{2}$ for spin « down ». Thus every one of the $2l+1$ states of given l is now double.

The basic assumption for the explanation of the periodic table is the following : Considering one particular electron, arbitrarily chosen, we shall assume that the action on it of all other electrons, as well as of the nucleus, can be approximated by a spherically potential $V(r)$. Since this potential is no longer proportional to the reciprocal distance the levels in it will be shifted, compared to hydrogen, and in such a way that the energy now depends on the angular momentum, measured by l , which is still quantized. The structure of the periodic system then follows from the Pauli principle: A quantum state of given n, l, m_l, m_s can be occupied by only one electron. In other words, an energy level characterized by l can be occupied by no more than $2(2l+1)$ electrons. One builds up the periodic table by increasing the nuclear charge Ze and with this the number of electrons Z . To get the ground state of the atom we have to fill the lowest individual electron levels successively with as many electrons as the Pauli principle permits. When two successive levels are far apart in energy, we speak of closing an atomic shell at the element for which the lower of these is filled. At the next element the next electron can only be brought into the atom at a much higher level, with much less binding energy.

This description of atomic structure may be termed the individual orbit model.

4. Individual orbits in the nucleus

In analogy with atomic structure one may postulate that in the nucleus the nucleons move fairly independently in individual orbits in an average potential which we assume to have spherical symmetry. The value of the angular momentum, l , is quantized and contains $(2l+1)$ states, $-l \leq m \leq l$.

The assumption of the occurrence of clear individual orbits of neutrons and protons in the nucleus is open to grave doubts. In the atom, there is firstly the dominant attraction of the nucleus. The Coulomb repulsion between the electrons is of long range, so that the potential acting on one electron does not depend sensitively on the precise position of the others. In the nucleus, on the other hand, the forces are of short range, so that the potential on one nucleon should depend strongly on the position of the others. In other words, one

would expect that a nucleon collides with another one long before it has traversed its orbit even once.

Actually, perturbation by collisions is not as severe as one would at first expect, since the Pauli principle forbids collisions that deflect nucleons into already filled orbits, and therefore most of the intuitively expected collisions do not occur. We shall pursue the description of the nucleus by the independent orbit model. It still remains surprising that the model works so well.

There are several differences between the nucleus and the electrons in the atom. Firstly, the average potentials in the two cases are quite different. Thus the atomic shell numbers and the nuclear magic numbers will be entirely different from each other. One expects that the average nuclear potential has the form of a trough in three dimensions, where the potential is negative and rather constant inside the nucleus, rising abruptly to zero at the edge.

The second difference is that the nucleus contains two kinds of particles, neutrons and protons, each with intrinsic spin $\frac{1}{2}$. We shall assume that the nuclear potential is the same for protons and neutrons. This assumption is now known to be in agreement with the evidence of many high-energy experiments, but at the time of the nuclear shell model development it was supported most strongly by the fact that the magic numbers were the same for neutrons and protons. The Pauli principle requires that just as in the case of electrons, a level of given l , can be occupied by no more than $2(2l + 1)$ nucleons *of one kind*.

In a potential trough the lowest level is 1 s, $l = 0$ with room for two neutrons and two protons. Two protons and two neutrons in this level make ${}^4\text{He}$. The next level is 1 p, $l = 1$, which has 6 states so that the 1 s and 1 p level together have room for 8 nucleons of one kind. Since there are two kinds, neutrons and protons, altogether 16 nucleons can be accommodated, leading to ${}^{16}\text{O}$. Thus the uniquely stable numbers are easily explained for the light nuclei.

This is by no means new, but based on Wigner's pioneering work⁵ on the light nuclei. Wigner's theory is able to explain with good approximation all the properties of light nuclei, spins, magnetic moments, transition probabilities, etc.

Its natural extension, however, failed in predicting the properties of heavy nuclei, and somehow, the theory of individual orbits in the nucleus went out of fashion. But nobody who has read Wigner's articles will ever forget them.

Fig. 5 shows some types of average potentials, a square well in 3 dimensions, a well with rounded edges, and a three-dimensional harmonic oscillator. The three-dimensional oscillator has equally spaced levels, which are highly degenerate, but which split up into several levels of different angular momentum



	QUANTUM OSCILLATOR	NUMBER SQUARE-WELL	NUMBER OF STATES	TOTAL NUMBER
SQUARE WELL POTENTIAL 	0	1s	2	2
	1	1p	6	8
OSCILLATOR POTENTIAL 	2	1d 2s	10 2	20
	3	1f 2p	14 6	40
	4	1g 2d 3s	18 10 2	70
TRUE ? 	5	1h 2f 3p	22 14 6	112
	6	1i 2g 3d 4s	26 18 10 2	168

Fig. 5. Energy levels in a square-well.

l in the square well. I shall frequently use the term « oscillator shell », by which I mean the group of levels which for the harmonic oscillator would have the same energy. All levels of one oscillator shell have the same parity, that is they contain either only odd, or only even values of l .

The right-hand side shows the order of the levels with different values of l , and the number of nucleons of each kind which fill these levels, in agreement with the Pauli principle.

The magic number 8 corresponds to filling all levels up to the oscillator shell $n=1$. The magic number 20 is still explained as filling the oscillator shells up to $n=2$. But beyond that the system breaks down. There is no experimental trace of a gap in the level system at the oscillator shell numbers of 40, 70 and 112, and no reason seen for the observed gaps at 28, 50 and 82, and 126. Actually, for a potential which has not the oscillator shape, but is a « square well » in character the gap in energy at the oscillator shells is no longer marked. The answer was that we had copied the atomic analogue too closely.

5. Nuclear shells

Elsasser had tried to explain the magic numbers by assuming that the nuclear potential in heavier nuclei is quite different from a square well. Subsequent work showed quite conclusively that a change in the shape of the potential, even a change which was quite unrealistic could not explain the magic numbers. It was kind of a jigsaw puzzle. One had many of the pieces (not only the magic number), so that one saw a picture emerging. One felt that if one had just one more piece everything would fit. The piece was found, and everything cleared up.

At that time Enrico Fermi had become interested in the magic numbers. I had the great privilege of working with him, not only at the beginning, but also later. One day as Fermi was leaving my office he asked: « Is there any indication of spin-orbit coupling? » Only if one had lived with the data as long as I could one immediately answer: « Yes, of course and that will explain everything. » Fermi was skeptical, and left me with my numerology.

I do not know how many false starts my German colleagues made, but I had certainly made many. This one was not. The magic numbers from 28 on can definitely not be obtained by any reasonable extrapolation from the lower numbers, but form a different sequence. There are two different series of numbers, 2, 8, 20, 40... , of which 40 is no longer noticeable, and another, 6, 14, 28, 50, 82, 126 of which the first two at 6 and 14 are hardly noticeable. The second series is due to spin-orbit coupling. In ten minutes the magic numbers were explained, and after a week, when I had written up the other consequences carefully, Fermi was no longer skeptical. He even taught it in his class in nuclear physics.

At about the same time Haxel, Jensen and Suess had the same idea.

Let me explain what spin-orbit coupling, or more correctly, coupling of spin and orbital angular momentum means. Earlier I have spoken somewhat vaguely about the quantum number of the intrinsic spin, m_s , which is $+1/2$ for « spin up » and $-1/2$ for « spin down ». Up and down with respect to what? If one has just one nucleon in a shell the only preferred direction is that of the orbital angular momentum. So spin, which is an angular momentum, can be parallel or anti-parallel to the orbital angular momentum. The total angular momentum has then the magnitude of $j = l + 1/2$ or $j = l - 1/2$. The number of states in each of two levels is $2j + 1$ due to differing orientation of the total angular momentum. There is no longer a factor 2, since the spin is now fixed. Notice that $[2(l + 1/2) + 1] + 2(l - 1/2) + 1 = 2(2l + 1)$, so that there are still

the same total number of states. I shall refer to the half integer j of a nucleon in a given state as its spin in this state.

The basic assumption of the shell model is that there is a strong interaction between spin and orbital angular momentum, giving the level $j = l + 1/2$ a considerably lower energy. Since the splitting is proportional to l , and presumably goes down somewhat with nuclear size, prominent gaps in the level structure will always occur when a high orbital angular momentum occurs for the first time. This explains the magic numbers. Let me show how this works for the number 28. The oscillator shell closes at 20. The next levels are $1f$ ($l=3$) and $2p$ ($l=1$), in that order. The $1f$ level splits into $j=7/2$ and $j=5/2$,

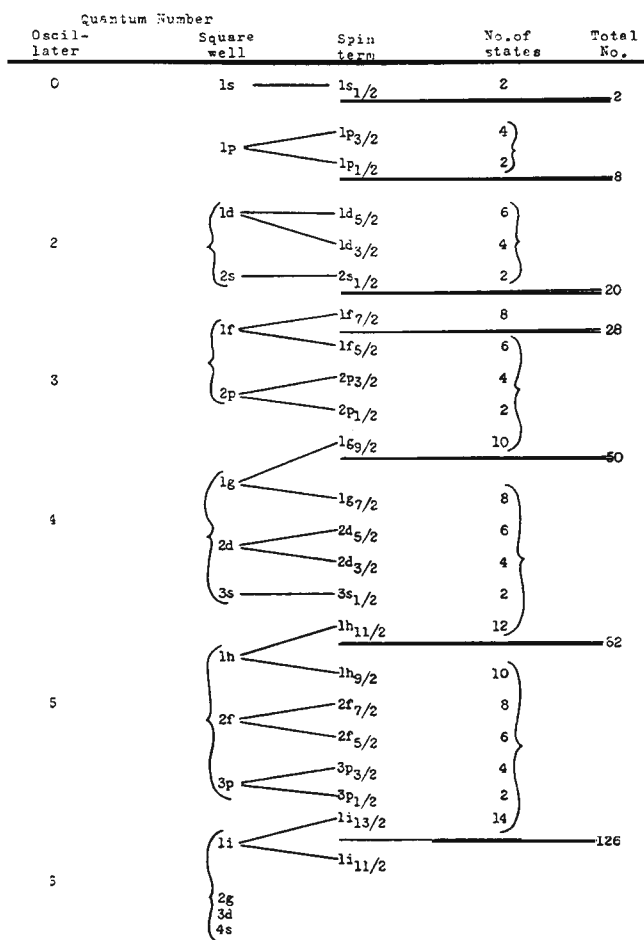

Fig. 6. Schematic level diagram.

with $7/2$ lower. Since the energy difference is large, and the $7/2$ level contains 8 states, we find the gap at $20 + 8 = 28$ nucleons. All the magic numbers are explained in the same way. And since they are explained and no longer magic, I shall from here on call them shell numbers.

The assumption of a strong spin-orbit coupling contradicted the earlier tradition which assumed that spin-orbit coupling was very weak. Our attitude was « We know so little about nuclear forces. » By now, there is ample evidence for the fact that spin-orbit interaction in nuclei is indeed an important effect. Fig. 6 shows a very schematic level scheme. At the left side are the numbers and levels of the oscillator shell. In the right-hand side is the level

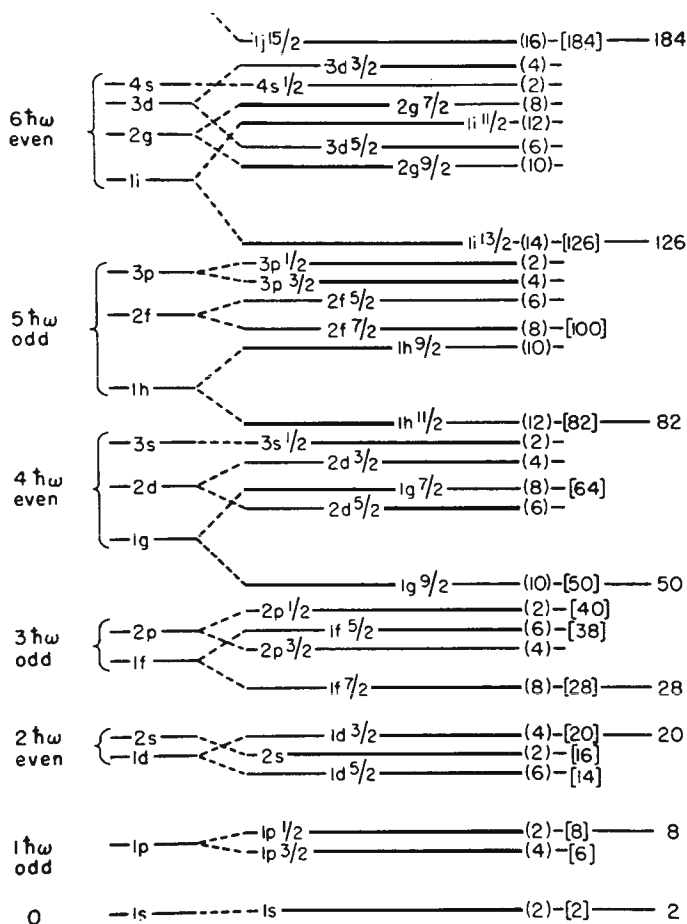

Fig. 7. Realistic level diagram for protons.

scheme with strong spin-orbit coupling. A magic number of neutrons or protons is obtained when the states of all oscillator shells up to a given one are filled with one each, and in addition the level of highest spin of the next oscillator is also filled with its complement of $2j + 1$ nucleons.

Fig. 7 shows a fairly realistic level scheme for protons. It shows the fairly small splitting of the $1p$ or $l = 1$ level. The splitting of the $1f$ ($l = 3$) $1g$ ($l = 4$) $1h$ ($l = 5$) are increasingly larger. Within the shells the level order is harder to predict. It depends on the relative strength of spin-orbit coupling and the deviation from the oscillator potential. The detailed order in which we put levels is dictated by experiment. For instance, in the shell with oscillator number 3 we find that the 29th proton, after the $7/2$ shell is filled, is in a $3/2$ orbit. So the level p ($l = 1$) $3/2$ is lower than the level f ($l = 3$) $5/2$, the partner to the $7/2$ state.

For neutrons, the level scheme is the same as for protons for the light nuclei up to neutron number 50. Above this, the Coulomb energy makes itself felt. It has the effect that the repulsion of protons favors orbits with higher angular momentum. Thus for neutrons, for instance, the 51st neutron is in the d level of $j = 5/2$, whereas the proton is in the g level of $j = 7/2$. This effect is never large enough to effect the shell number.

6. Predictions of the shell model

To be a reasonable model of nuclear structure the shell model must be able to explain and predict other nuclear properties than just a half dozen numbers. It is indeed able to do this.

Let me first consider the angular momenta, or nuclear spins, not of the individual nucleons but of the whole complex nuclei, which I shall designate by capital J . Hundreds of these have been measured. A closed shell, or a filled level, has angular momentum zero, since all states of different direction of the angular momentum contain one nucleon. Hence, nuclei with one nucleon outside (or one nucleon missing from) a closed shell of neutrons and of protons, or even of filled levels of both, should have a nuclear spin corresponding to the level of the single last nucleon and the spin of the individual particle orbit is predicted by the shell model. This is quite a severe test, since we find there would be no possible way to explain a disagreement with the model. Happily, all known nuclei of this type have indeed the predicted spin and parity.

Examples are ${}^{17}_8\text{O}_9$, with one nucleon outside the doubly closed shell of ${}^{16}_8\text{O}_8$, which has a spin of $5/2$ and positive parity, which is the prediction. Another is ${}^{209}_{83}\text{Bi}_{126}$, which has one nucleon outside the closed shells of 82 protons and 126 neutrons and has a spin $9/2$, in agreement with the predictions.

In nuclei where both neutrons and protons fill shells incompletely, the individual nucleons add their spin vectors to a total spin vector J . Even with the restriction of the Pauli principle, very many states of total angular momenta exist. For instance, if there are three identical nucleons in the $7/2$ shell there are 6 levels of different magnitude of total angular momentum, ranging from $3/2$ to $15/2$. It is very fortunate that of the vast number of complicated levels only the simplest ones occur as the ground state of nuclei.

There are further regularities. For instance, in bismuth there exist 5 isotopes of odd mass number in which the neutron number is even. All have a nuclear spin measured to be $9/2$ namely, that of the 83rd proton. Thus the even numbers of neutrons, ranging in this case from 116 to 126 do not influence the spin.

Another example is the region where the first $7/2$ shell is being filled. Here we know the spins of 8 nuclei with an even number of protons and odd number of neutrons ranging from 21 to 27. Seven of these have nuclear spins $7/2$, one has $5/2$. There are also 5 nuclei with an even number of neutrons and an odd number of protons ranging from 21 to 27, of which 4 have spins $7/2$, one has $5/2$. The numbers 21 to 27 correspond to 1, 3, 5, 7 nucleons in the $7/2$ shell. So for nuclei in which both neutrons and protons fill shells incompletely, there emerge rules by which one may predict how the individual nucleons couple their spins to the total nuclear spin J . In a nucleus with an even number of neutrons and odd number of protons the neutrons couple their spins to zero and do not influence the nuclear angular momentum. The protons usually couple their spins to a total angular momentum J which is equal to the angular momentum j of the level being filled, and only rarely less by one unit. The same statement holds when the words neutron and proton are interchanged.

These rules are sometimes expressed in a different way and lead to what is called the single-particle model. It is an experimental fact that all nuclei with an even number of neutrons and of protons have angular momentum zero. Thus, in a nucleus of even neutron number N , odd proton number Z , there is an even-even nuclear core with N neutrons and $Z-1$ protons. The last proton occupies an orbit around the spinless core, and this orbit is prescribed by the shell model. All nuclear properties, spin, magnetic moment, etc. are en-

tirely due to the last odd particle. Actually the shell model has never been proposed in quite so simple and naive a fashion.

These coupling rules, considerably less complex than those for atoms, do have some theoretical basis, namely a simplified calculation of energies predicts them. If one considers just several particles of the same kind in the same level j , and assumes that they interact with each other with a very short range force, one finds indeed that for an even number of nucleons the ground state has spin zero. For an odd number, the ground state has the spin J which is equal to the j of the level being filled. The eigen functions of $J=0$ for even, and of $J=j$ for odd particle number are those of lowest seniority.

With these rules we should be able to explain or predict the spins of all nuclei. Up to neutron or proton number a little above 50 this simple theory and experiment are in excellent agreement. Beyond this, there are very many levels in the shell 50-82 and these levels lie close together in energy, so that one can explain just about anything. Besides, nuclei with more than 90 neutrons are highly deformed, and the assumption of a potential with spherical symmetry is no longer the best starting point. This will be discussed in the next lecture. However as the closed shells $Z=82$ and $N=126$ are approached, there is no longer a large deformation, and the predicted and measured spins again agree.

Another quantum number which the model predicts is the parity. We not only predict the spin, but also the angular momentum l of each level. A level with odd l has odd parity, one with even l has even parity. Parity can be measured in various ways, and there is again complete agreement with the predictions.

Besides the ground states of nuclei one can also investigate the excited states. One type of excited states are the isomeric levels, which are levels of a very long lifetime, hours, days or even years. The explanation of this phenomenon is that the spins of the isomeric state and the ground state are very different, so that the return to the ground state by the emission of a light quantum is greatly hindered since the light quantum has to take up the difference in angular momentum. The transitions are not dipole but octupole or 2^4 pole transitions, which are very slow. In nuclei of odd mass number an excited state can be produced by raising the last odd nucleon into an adjacent higher level. Now there are only very definite regions where low and high spins are close in energy, namely at the end of the shells where the lowest angular momenta of one oscillator shell occur, and immediately above them the states of highest angular momentum of the next oscillator level. Thus, isomerism should occur

only if the number of last odd particle is between 38 and 50, or between 64 and 82, or between 100 and 126. In addition, the shell model predicts that all these transitions involve a change in parity. This is a rather strong statement and ties isomerism to the neutron or proton number.

Some of the best work on isomerism has been done in Sweden⁴ and has led to one of the nicest confirmations of the shell model. The three regions of isomerism are now called islands of isomerism. Long-lived and low-lying isomeric levels in nuclei of odd A occur only in the three islands. If one considers the mass number only, no regularities appear, since different islands of proton isomerism and neutron isomerism overlap in mass numbers.

For instance ${}_{49}^{115}\text{In}$ in the first island has an isomeric state with a half-life of 5.1 hours. This is due to the transition of a proton from the $j = 1/2$ level to the ground state which has spin g/z . For mass numbers higher by two, one finds ${}_{50}^{117}\text{Sn}$ with an isomeric state of half-life 14 days. This is due to the odd neutron, which goes from the excited level $j = 11/2$ to a level $j = 3/2$ which is expected to happen in the second island.

7. Failures of the shell model

After all this praise of the shell model, it is high time to emphasize its shortcomings. Even a crude nuclear model should be able to explain quantum numbers, like the spin, which is either integer or half integer, but never in between, or parity, which is either even or odd. The shell model, as I have presented it, can indeed do this, and in this form has the advantage that it can explain or predict these quantum numbers for most nuclei.

However, the single-particle model, namely the rule for the coupling of the spins of individual nucleons, which essentially postulate that everything depends only on the last odd nucleon can be at best a very rough approximation to the truth. This becomes obvious when one tries to calculate nuclear properties which are not integers but can be measured to seven significant figures. One would hope to get approximate agreement, say to 10%. Unfortunately, this is not so. For example, take the magnetic moments of nuclei. For a nucleus with odd proton, even neutron number, the magnetic moments, according to the shell model, should depend only on the state of the last odd proton and are easy to compute. For any value of the spin, we calculate two different values of the magnetic moment, for the two different values of l , $l = j - 1/2$ and $l = j + 1/2$. In Fig. 8 the magnetic moments of odd proton, even neutron

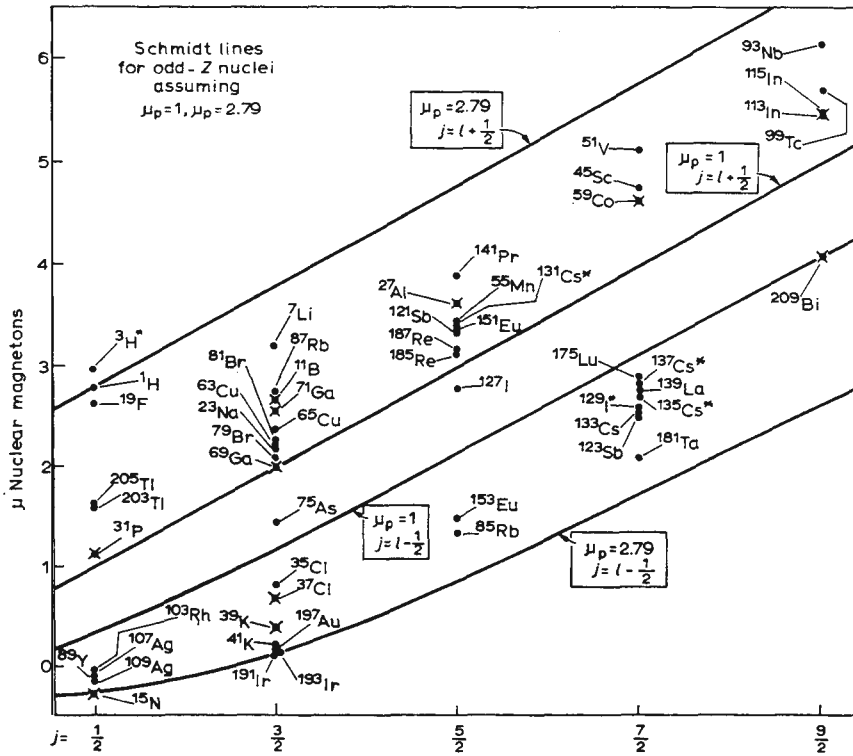

Fig. 8. Magnetic moments of nuclei with odd proton, even neutron number.

nuclei are plotted with the nuclear angular momentum as abscissa. The lines at the two extremes are the calculated ones. The middle lines are what one would obtain if the proton were a simple Dirac particle, and are added merely to emphasize the division into two groups. The difference between calculated and measured values are distressingly large. Only one general trend remains. The nuclei in the upper group, nearer to the line for $j = l + 1/2$ are indeed those for which we found that spin and orbital angular momentum are parallel, those in the lower group were assigned anti-parallel orientation.

This shows that much more careful calculations of the interaction between the nucleons are required to get better numerical agreement. For individual nuclei, or special groups of nuclei, such calculations have been made by many people using the shell model as first approximation, and different procedures to compute higher approximations. In particular, Talmi⁷ has made great progress in developing a more refined shell model.

Finally, even the assumption of strong spin-orbit coupling is open to criti-

cism, at least for the light nuclei. For these the model can easily be refined by taking into account both protons and neutrons in the nucleus, and constructing eigen functions of lowest isotopic spin. One should compare the results obtained to those of Wigner's calculations⁵. Although Wigner also used the independent particle model, his method is in some sense the direct antithesis to the shell model. In Wigner's theory, spin-orbit coupling is assumed to be very weak, whereas in the shell model spin and orbital angular momentum are assumed to be rigidly coupled.

Actually, Wigner's values for all nuclear properties agree better with the experimental results for the light nuclei. It seems that the truth is in the middle, spin-orbit coupling is present, but not predominant. The calculation for "intermediate" coupling are more involved than either extreme, but they have been done by many peoples for different nuclei, and have led to much closer agreement between theory and experiment.

The shell model has initiated a large field of research. It has served as the starting point for more refined calculations. There are enough nuclei to investigate so that the shell modellists will not soon be unemployed.

1. K.A. Brueckner, A.M. Lockett and M. Rotenberg, *Phys. Rev.*, 121 (1961) 255.
2. H.A. Bethe and J. Goldstone, *Proc. Roy. Soc. (London), Ser. A*, 238 (1957) 551.
3. W. Elsasser, *J. Phys. Radium*, 4 (1933) 549.
4. H.E. Suess and J.H.D. Jensen, *Arkiv Fysik*, 3 (1951) 577.
5. E. Feenberg and E. Wigner, *Phys. Rev.*, 51 (1937) 144.
6. E. Wigner, *Phys. Rev.*, 51 (1937) 947. See, for instance, references in M. Goldhaber and A. W. Sunyar, *Phys. Rev.*, 83 (1951) 906.
7. A. de- Shalit and I. Talmi, Academic Press, New York, 1963.
8. For reverences see article by D. Kurath, in K. Siegbahn (Ed.), *Alpha, Beta and Gamma Ray Spectroscopy* , Vol. I, North Holland, Amsterdam, 1965, p. 583.