

GUGLIELMO MARCONI

## Wireless telegraphic communication

*Nobel Lecture, December 11, 1909*

The discoveries connected with the propagation of electric waves over long distances and the practical applications of telegraphy through space, which have gained for me the high honour of sharing the Nobel Prize for Physics, have been to a great extent the results of one another.

The application of electric waves to the purposes of wireless telegraphic communication between distant parts of the earth, and the experiments which I have been fortunate enough to be able to carry out on a larger scale than is attainable in ordinary laboratories, have made it possible to investigate phenomena and note results often novel and unexpected.

In my opinion many facts connected with the transmission of electric waves over great distances still await a satisfactory explanation, and I hope to be able in this lecture to refer to some observations, which appear to require the attention of physicists.

In sketching the history of my association with radiotelegraphy, I might mention that I never studied physics or electrotechnics in the regular manner, although as a boy I was deeply interested in those subjects.

I did, however, attend one course of lectures on physics under the late Professor Rosa at Livorno, and I was, I think I might say, fairly well acquainted with the publications of that time dealing with scientific subjects including the works of Hertz, Branly, and Righi.

At my home near Bologna, in Italy, I commenced early in 1895 to carry out tests and experiments with the object of determining whether it would be possible by means of Hertzian waves to transmit to a distance telegraphic signs and symbols without the aid of connecting wires.

After a few preliminary experiments with Hertzian waves I became very soon convinced, that if these waves or similar waves could be reliably transmitted and received over considerable distances a new system of communication would become available possessing enormous advantages over flashlights and optical methods, which are so much dependent for their success on the clearness of the atmosphere.

My first tests were carried out with an ordinary Hertz oscillator and a

Branly coherer as detector, but I soon found out that the Branly coherer was far too erratic and unreliable for practical work.

After some experiments I found that a coherer constructed as shown in Fig. 1, and consisting of nickel and silver filings placed in a small gap between two silver plugs in a tube, was remarkably sensitive and reliable. This improvement together with the inclusion of the coherer in a circuit tuned to the wavelength of the transmitted radiation, allowed me to gradually extend up to about a mile the distance at which I could affect the receiver.

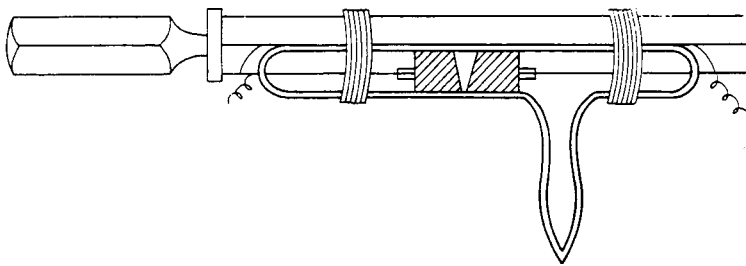

Fig. 1.

Another, now well-known, arrangement which I adopted was to place the coherer in a circuit containing a voltaic cell and a sensitive telegraph relay actuating another circuit, which worked a tapper or trembler and a recording instrument. By means of a Morse telegraphic key placed in one of the circuits of the oscillator or transmitter it was possible to emit long or short successions of electric waves, which would affect the receiver at a distance and accurately reproduce the telegraphic signs transmitted through space by the oscillator.

With such apparatus I was able to telegraph up to a distance of about half a mile.

Some further improvements were obtained by using reflectors with both the transmitters and receivers, the transmitter being in this case a Righi oscillator.

This arrangement made it possible to send signals in one definite direction, but was inoperative if hills or any large obstacle happened to intervene between the transmitter and receiver.

In August 1895 I discovered a new arrangement which not only greatly increased the distance over which I could communicate, but also seemed to make the transmission independent from the effects of intervening obstacles.

This arrangement (Figs. 2 and 3) consisted in connecting one terminal of the Hertzian oscillator, or spark producer, to earth and the other terminal to a wire or capacity area placed at a height above the ground, and in also connecting at the receiving end one terminal of the coherer to earth and the other to an elevated conductor.

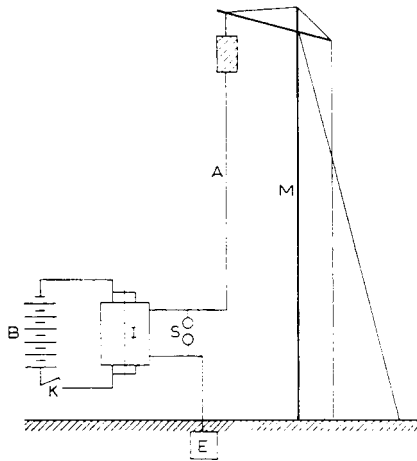

Fig. 2.

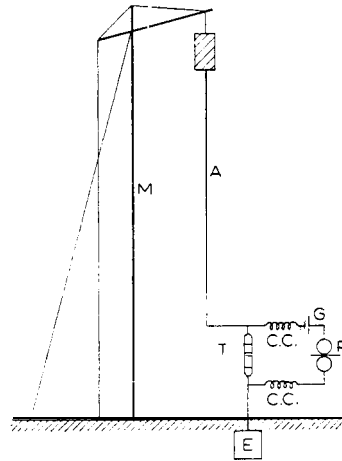

Fig. 3.

I then began to examine the relation between the distance at which the transmitter could affect the receiver and the elevation of the capacity areas above the earth, and I very soon definitely ascertained that the higher the wires or capacity areas, the greater the distance over which it was possible to telegraph.

Thus I found that when using cubes of tin of about 30 cm side as elevated conductors or capacities, placed at the top of poles 2 meters high, I could receive signals at 30 meters distance, and when placed on poles 4 meters high, at 100 meters, and at 8 meters high at 400 meters. With larger cubes 100 cm side, fixed at a height of 8 meters, signals could be transmitted 2,400 meters all round.<sup>1</sup>

These experiments were continued in England, where in September 1896 a distance of 1 3/4 miles was obtained in tests carried out for the British Government at Salisbury. The distance of communication was extended to 4 miles in March 1897, and in May of the same year to 9 miles. Tape messages obtained during these tests, signed by the British Government Officers who were present, are exhibited.<sup>2</sup>

In all these experiments a very small amount of electrical power was used,

the high tension current being produced by an ordinary Rhumkorff coil.

The results obtained attracted a good deal of public attention at the time, such distances of communication being considered remarkable.

As I have explained, the main feature in my system consisted in the use of elevated capacity areas or antennae attached to one pole of the high frequency oscillators and receivers, the other pole of which was earthed.

The practical value of this innovation was not understood by many physicists<sup>3</sup> for quite a considerable period, and the results which I obtained were by many erroneously considered simply due to efficiency in details of construction of the receiver, and to the employment of a large amount of energy.

Others did not overlook the fact that a radical change had been introduced by making these elevated capacities and the earth form part of the high frequency oscillators and receivers.

Prof. Ascoli of Rome gave a very interesting theory of the mode of operation of my transmitters and receivers in the *Elektricista* (Rome) issue of August 1897, in which he correctly attributed the results obtained to the use of elevated wires or antennae.

Prof. A. Slaby of Charlottenburg, after witnessing my tests in England in 1897, came to somewhat similar conclusions.<sup>4</sup>

Many technical writers have stated that an elevated capacity at the top of the vertical wire is unnecessary.

This is true if the length or height of the wire is made sufficiently great, but as this height may be much smaller for a given distance if a capacity area is used, it is more economical to use such capacities, which now usually consist of a number of wires spreading out from the top of the vertical conductor.

The necessity or utility of the earth connection has been sometimes questioned, but in my opinion no practical system of wireless telegraphy exists where the instruments are not connected to earth.

By "connected to earth" I do not necessarily mean an ordinary metallic connection as used for ordinary wire telegraphs.

The earth wire may have a condenser in series with it, or it may be connected to what is really equivalent, a capacity area placed close to the surface of the ground (Fig. 4).

It is now perfectly well known that a condenser, if large enough, does not prevent the passage of high frequency oscillations, and therefore in these cases the earth is for all practical purposes connected to the antennae.

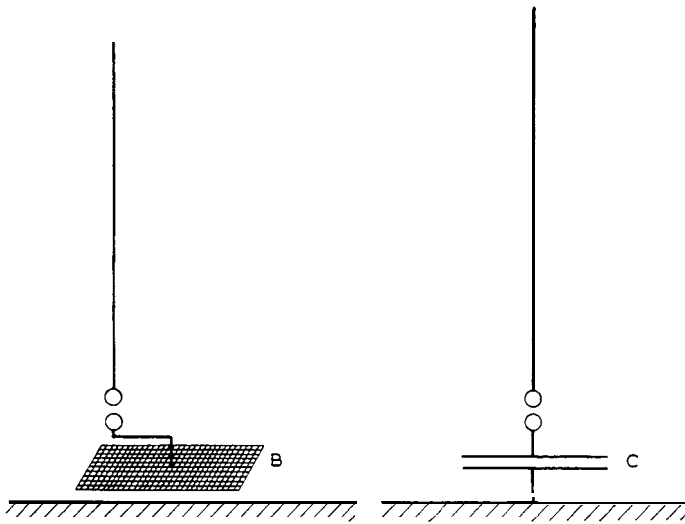

Fig. 4.

After numerous tests and demonstrations in Italy and England over distances varying up to 40 miles, communication was established for the first time across the English Channel between England and France<sup>5</sup> in March 1899 (Fig. 5).

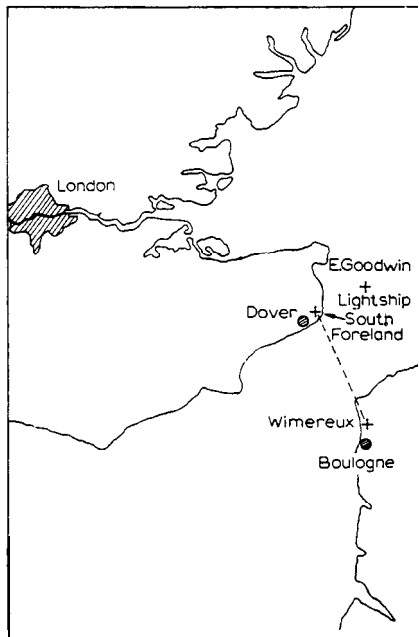

Fig. 5.

From the beginning of 1898 I had practically abandoned the system of connection shown in Fig. 2, and instead of joining the coherer or detector directly to the aerial and earth, I connected it between the ends of the secondary of a suitable oscillation transformer containing a condenser and tuned to the period of the electrical waves received. The primary of this oscillation transformer was connected to the elevated wire and to earth (See Fig. 6.)

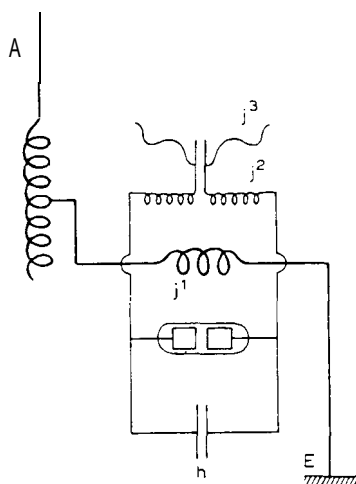

Fig. 6.

This arrangement allowed of a certain degree of syntony, as by varying the period of oscillation of the transmitting antennae, it was possible to send messages to a tuned receiver without interfering with others differently syntonized.<sup>6</sup>

As is now well known, a transmitter consisting of a vertical wire discharging through a spark gap is not a very persistent oscillator, the radiation it produces being considerably damped. Its electrical capacity is comparatively so small and its capability of radiating energy so large, that the oscillations decrease or die off with rapidity. In this case receivers or resonators of a considerably different period or pitch are likely to be affected by it.

Early in 1899 I was able to improve the resonance effects obtainable by increasing the capacity of the elevated wires by placing adjacently to them earthed conductors, and inserting in series with the aerials suitable inductance coils.<sup>7</sup>

By these means the energy-storing capacity of the aerial was increased,

whilst its capability to radiate was decreased, with the result that the energy set in motion by the discharge formed a train or succession of feebly damped oscillations.

A modification of this arrangement, by which excellent results were obtained, is shown in Fig. 7.

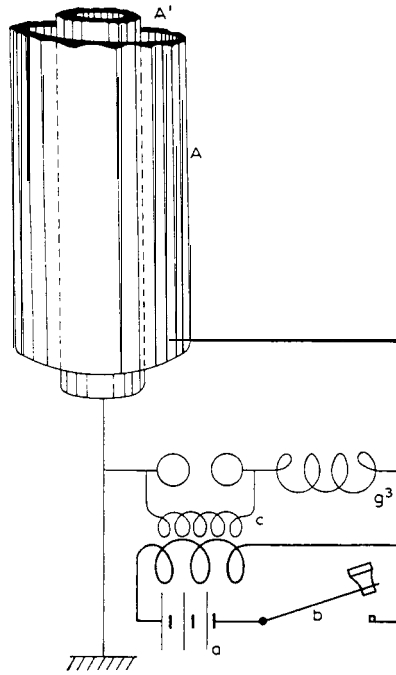

Fig. 7.

In 1900 I constructed and patented a complete system of transmitters and receivers<sup>8</sup> which consisted of the usual kind of elevated capacity area and earth connection, but these were inductively coupled to an oscillation circuit containing a condenser, an inductance, and a spark gap or detector, the conditions which I found essential for efficiency being that the periods of electrical oscillation of the elevated wire or conductor should be in tune or resonance with that of the condenser circuit, and that the two circuits of the receiver should be in electrical resonance with those of the transmitter (Fig. 8).

The circuits consisting of the oscillating circuit and the radiating circuit were more or less closely "coupled" by varying the distance between them.

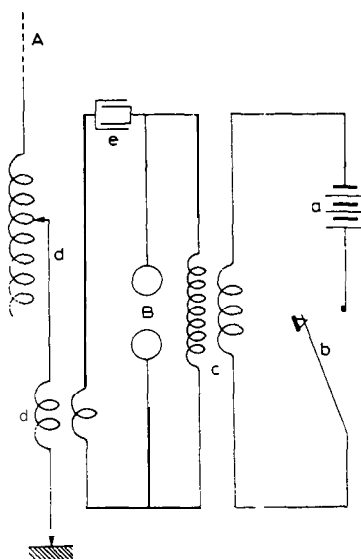

Fig. 8.

By the adjustment of the inductance inserted in the elevated conductor and by the variation of capacity of the condenser circuit, the two circuits were brought into resonance, a condition which, as I have said, I found essential in order to obtain efficient radiation.

Part of my work regarding the utilization of condenser circuits in association with the radiating antennae was carried out simultaneously to that of Prof. Braun, without, however, either of us knowing at the time anything of the contemporary work of the other.

A syntonie receiver has already been shown in Fig. 6, and consists of a vertical conductor or aerial connected to earth through the primary of an oscillation transformer, the secondary circuit of which included a condenser and a detector, it being necessary that the circuit containing the aerial and the circuit containing the detector should be in electrical resonance with each other, and also in tune with the periodicity of the electric waves transmitted from the sending station.

In this manner it was possible to utilize electric waves of low decrement and cause the receiver to integrate the effect of comparatively feeble but properly timed electrical oscillations in the same way as in acoustics two tuning forks can be made to affect each other at short distances if tuned to the same period of vibration.



It is also possible to couple to one sending conductor several differently tuned transmitters and to a receiving wire a number of corresponding receivers, as is shown in Figs. 9 and 10, each individual receiver responding

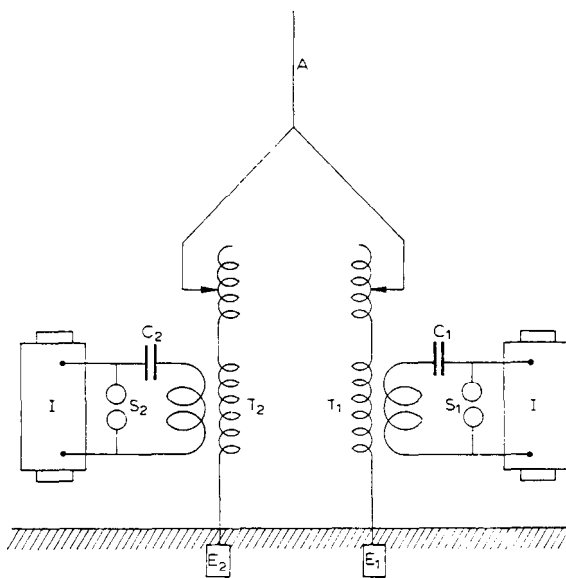

Fig. 9.

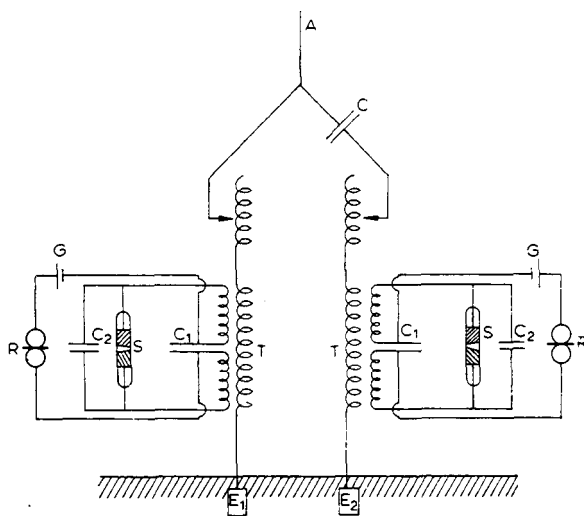

Fig. 10.

only to the radiations of the transmitter with which it is in resonance.<sup>9</sup>

At the time (twelve years ago) when communication was first established by means of radiotelegraphy between England and France, much discussion and speculation took place as to whether or not wireless telegraphy would be practicable for much longer distances than those then covered, and a somewhat general opinion prevailed that the curvature of the Earth would be an insurmountable obstacle to long distance transmission, in the same way as it was, and is, an obstacle to signalling over considerable distances by means of light flashes.

Difficulties were also anticipated as to the possibility of being able to control the large amount of energy which it appeared would be necessary to cover long distances.

What often happens in pioneer work repeated itself in the case of radiotelegraphy, the anticipated obstacles or difficulties were either purely imaginary or else easily surmountable, but in their place unexpected barriers manifested themselves, and recent work has been mainly directed to the solution of problems presented by difficulties which were certainly neither expected nor anticipated when long distances were first attempted.

With regard to the presumed obstacle of the curvature of the Earth, I am of opinion that those who anticipated difficulties in consequence of the shape of our planet had not taken sufficient account of the particular effect of the earth connection to both transmitter and receiver, which earth connection introduced effects of conduction which were generally at that time overlooked.

Physicists seemed to consider for a long time that wireless telegraphy was solely dependent on the effects of free Hertzian radiation through space, and it was years before the probable effect of the conductivity of the Earth between the stations was satisfactorily considered or discussed.

Lord Rayleigh, in referring to transatlantic telegraphy, stated in May 1903 : "The remarkable success of Marconi in signalling across the Atlantic

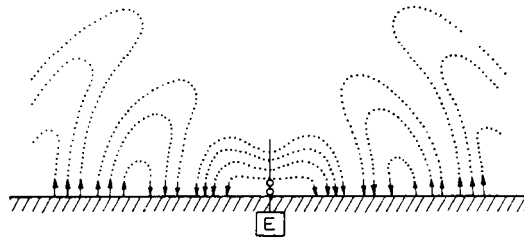

Fig. 11.

suggests a more decided bending or diffraction of the waves round the perturberant Earth than had been expected, and it imparts a great interest to the theoretical problem<sup>10</sup>.

Prof. J. A. Fleming, in his book on *The Principles of Electric Wave Telegraphy*<sup>11</sup>, gives diagrams showing what is now believed to be the diagrammatic representation of the detachment of semi-loops of electric strain from a simple vertical wire (Fig. 11). As will be seen, these waves do not propagate in the same manner as free radiation from a classical Hertzian oscillator, but glide along the surface of the Earth.

Prof. Fleming further states in the above quoted work:

"The view we here take is that the ends of the semi-loops of electric force, which terminate perpendicularly on the Earth, cannot move along unless there are movements of electrons in the Earth corresponding to the wave-motions above it. From the point of view of the electronic theory of electricity, every line of electric force in the ether must be either a closed line or its ends must terminate on electrons of opposite sign. If the end of a line of strain abuts on the Earth and moves, there must be atom-to-atom exchange of electrons, or movements of electrons in it. We have many reasons for concluding that the substances we call conductors are those in which free movements of electrons can take place. Hence the movements of the semi-loops of electric force outwards from an earthed oscillator or Marconi aerial is hindered by bad conductivity on the surface of the Earth and facilitated over the surface of a fairly good electrolyte, such as sea-water."

Prof. Zenneck<sup>12</sup> has carefully examined the effect of earthed transmitting and receiving aerials, and has endeavoured to show mathematically that when the lines of electrical force, constituting a wave front, pass along a surface of low specific inductive capacity, such as the Earth, they become inclined forward, their lower ends being retarded by the resistance of the conductor to which they are attached.

It therefore seems well established that wireless telegraphy, as practised at the present day, is dependent for its operation over long distances on the conductivity of the Earth, and that the difference in conductivity between the surface of the sea and land is sufficient to explain the increased distance obtainable with the same amount of energy in communicating over sea as compared to over land.

I carried out some tests between a shore station and a ship at Poole, in England, in 1902, for the purpose of obtaining some data on this point, and I noticed that at equal distances a perceptible diminution in the energy of the

received waves always occurred when the ship was in such a position as to allow a low spit of sand about 1 kilometer broad to intervene between it and the land station.

I therefore believe that there was some foundation for the statement so often criticized which I made in my first English Patent of June 2, 1896 to the effect that when transmitting through the earth or water I connected one end of the transmitter and one end of the receiver to earth.

In January 1901 some successful experiments<sup>13</sup> were carried out between two points on the South Coast of England 186 miles apart, i.e. St. Catherines' Point (Isle of Wight) and The Lizard in Cornwall (Fig. 12).

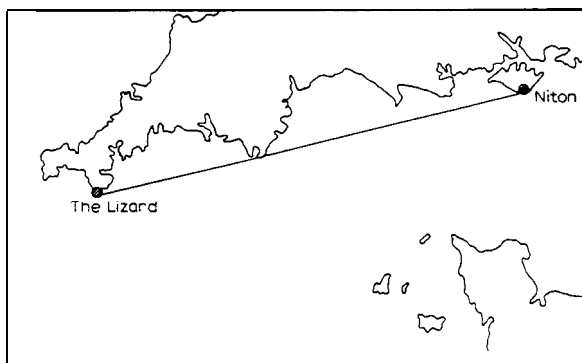

Fig. 12.

The total height of these stations above sea level did not exceed 100 meters, whereas to clear the curvature of the Earth a height of more than 1,600 meters at each end would have been necessary.

The results obtained from these tests, which at the time constituted a record distance, seemed to indicate that electric waves produced in the manner I had adopted would most probably be able to make their way round the curvature of the Earth, and that therefore even at great distances, such as those dividing America from Europe, the factor of the Earth's curvature would not constitute an insurmountable barrier to the extension of telegraphy through space.

The belief that the curvature of the Earth would not stop the propagation of the waves, and the success obtained by syntonic methods in preventing mutual interference, led me in 1900 to decide to attempt the experiment of testing whether or not it would be possible to detect electric waves over a

distance of 4,000 kilometers, which, if successful, would immediately prove the possibility of telegraphing without wires between Europe and America.

The experiment was in my opinion of great importance from a scientific point of view, and I was convinced that the discovery of the possibility to transmit electric waves across the Atlantic Ocean, and the exact knowledge of the real conditions under which telegraphy over such distances could be carried out, would do much to improve our understanding of the phenomena connected with wireless transmission.

The transmitter erected at Poldhu, on the coast of Cornwall, was similar in principle to the one I have already referred to, but on a very much larger scale than anything previously attempted.<sup>14</sup>

The power of the generating plant was about 25 kilowatts.

Numerous difficulties were encountered in producing and controlling for the first time electrical oscillations of such power. In much of the work I obtained valuable assistance from Prof. J. A. Fleming, Mr. R. N. Vyvyan, and Mr. W. S. Entwistle.

My previous tests had convinced me that when endeavouring to extend the distance of communication, it was not merely sufficient to augment the power of the electrical energy of the sender, but that it was also necessary to increase the area or height of the transmitting and receiving elevated conductors.

As it would have been too expensive to employ vertical wires of great height, I decided to increase their number and capacity, which seemed likely to make possible the efficient utilization of large amounts of energy.

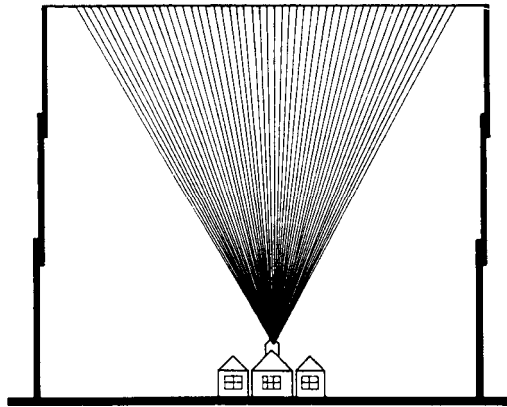

Fig. 13.

The arrangement of transmitting antennae which was used at Poldhu is shown in Fig. 13, and consisted of a fan-like arrangement of wires supported by an insulated stay between masts only 48 meters high and 60 meters apart. These wires converged together at the lower end and were connected to the transmitting apparatus contained in a building.

For the purpose of the test a powerful station had been erected at Cape Cod, near New York, but the completion of the arrangements at that station were delayed in consequence of a storm which destroyed the masts and antennae.

I therefore decided to try the experiments by means of a temporary receiving station erected in Newfoundland, to which country I proceeded with two assistants about the end of November 1901.

The tests were commenced early in December 1901 and on the 12th of that month the signals transmitted from England were clearly and distinctly received at the temporary station at St. John's in Newfoundland.

Confirmatory tests were carried out in February 1902 between Poldhu and a receiving station on the S.S. "Philadelphia" of the American Line. On board this ship readable messages were received by means of a recording instrument up to a distance of 1,551 miles and test letters as far as 2,099 miles from Poldhu (Fig. 14).

The tape records obtained on the "Philadelphia" at the various distances were exceedingly clear and distinct, as can be seen by the specimens exhibited.

These results, although achieved with imperfect apparatus, were sufficient to convince me and my co-workers that by means of permanent stations and the employment of sufficient power it would be possible to transmit messages across the Atlantic Ocean in the same way as they were sent over much shorter distances.

The tests could not be continued in Newfoundland owing to the hostility of a cable company, which claimed all rights for telegraphy, whether wireless or otherwise, in that colony.

A result of scientific interest which I first noticed during the tests on S.S. "Philadelphia" and which is a most important factor in long distance radiotelegraphy, was the very marked and detrimental effect of daylight on the propagation of electric waves at great distances, the range by night being usually more than double that attainable during daytime.<sup>15</sup>

I do not think that this effect has yet been satisfactorily investigated or explained. At the time I carried out the tests I was of opinion that it might be

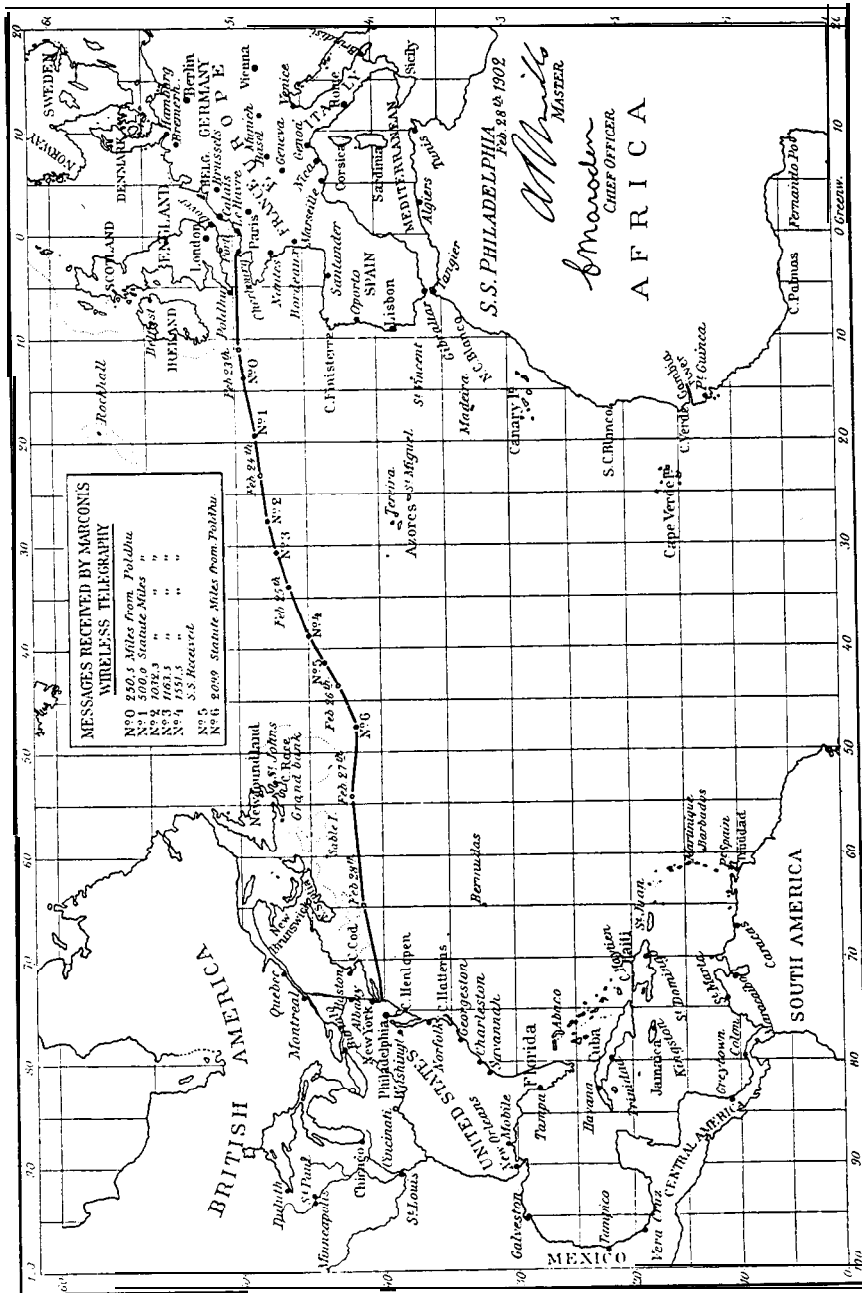

Fig. 14.

due to the loss of energy at the transmitter, caused by the dis-electrification of the highly charged transmitting elevated conductor under the influence of sunlight.

I am now inclined to believe that the absorption of electric waves during the daytime is due to the electrons propagated into space by the sun, and that if these are continually falling like a shower upon the earth, in accordance with the hypothesis of Prof. Arrhenius, then that portion of the Earth's atmosphere which is facing the sun will have in it more electrons than the part which is not facing the sun, and therefore it may be less transparent to electric waves.

Sir J. J. Thomson has shown in an interesting paper in the *Philosophical Magazine* that if electrons are distributed in a space traversed by electric waves, these will tend to move the electrons in the direction of the wave, and will therefore absorb some of the energy of the wave. Hence, as Prof. Fleming has pointed out in his Cantor Lectures delivered at the Society of Arts, a medium through which electrons or ions are distributed acts as a slightly turbid medium to long electric waves.<sup>16</sup>

Apparently the length of wave and amplitude of the electrical oscillations have much to do with this interesting phenomenon, long waves and small amplitudes being subject to the effect of daylight to a much lesser degree than short waves and large amplitudes.

According to Prof. Fleming<sup>17</sup> the daylight effect should be more marked on long waves, but this has not been my experience. Indeed, in some very recent experiments in which waves of about 8,000 meters long were used, the energy received by day was usually greater than at night.

The fact remains, however, that for comparatively short waves, such as are used for ship communication, clear sunlight and blue skies, though transparent to light, act as a kind of fog to these waves. Hence the weather conditions prevailing in England, and perhaps in this country, are usually suitable for wireless telegraphy.

During the year 1902 I carried out some further tests between the station at Poldhu and a receiving installation erected on the Italian Cruiser "Carlo Alberto", kindly placed at my disposal by H.M. The King of Italy. (See Fig. 15.<sup>18</sup>)

During these experiments the interesting fact was observed that, even when using waves as short as 1,000 feet, intervening ranges of mountains, such as the Alps or Pyrenees, did not, during the night time, bring about any considerable reduction in the distance over which it was possible to communicate. During daytime, unless much longer waves and more power were used, intervening mountains greatly reduced the apparent range of the transmitter.

Messages and press despatches of considerable length were received from



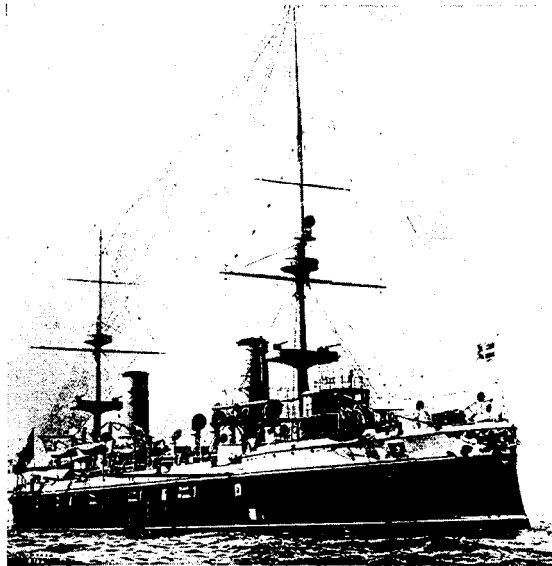

Fig. 15.

Poldhu at the positions marked on the map, which map is a copy, on a reduced scale, of the one accompanying the official report of the experiments (Fig. 16).

With the active encouragement and financial assistance of the Canadian Government, a high power station was constructed at Glace Bay, Nova Scotia, in order that I should be able to continue my long-distance tests with a view to establishing radiotelegraphic communication on a commercial basis between England and America.<sup>19</sup>

On December 16, 1902 the first official messages were exchanged at night across the Atlantic, between the stations at Poldhu and Glace Bay (Figs. 17 and 18).

Further tests were shortly afterwards carried out with another long-distance station at Cape Cod in the United States of America, and under favourable circumstances it was found possible to transmit messages to Poldhu 3,000 miles away with an expenditure of electrical energy of only about 10 kilowatts.

In the spring of 1903 the transmission of press messages by radiotelegraphy from America to Europe was attempted, and for a time the London *Times* published, during the latter part of March and the early part of April of that year, news messages from its New York correspondent sent across the Atlantic without the aid of cables.

A breakdown in the insulation of the apparatus at Glace Bay made it necessary, however, to suspend the service and unfortunately further accidents made the transmission of messages uncertain and unreliable.

As a result of the data and experience gained by these and other tests which I carried out for the British Government, between England and Gibraltar, I was able to erect a new station at Clifden in Ireland, and enlarge the one at Glace Bay in Canada, so as to enable me to initiate, in October 1907, communication for commercial purposes across the Atlantic between England and Canada.

Although the stations at Clifden and Glace Bay had to be put into operation before they were altogether complete, nevertheless communication across the Atlantic by radiotelegraphy never suffered any serious interruption during nearly two years, until, in consequence of a fire at Glace Bay this autumn, it has had to be suspended for three or four months.

This suspension has not, however, been altogether an unmitigated evil, as

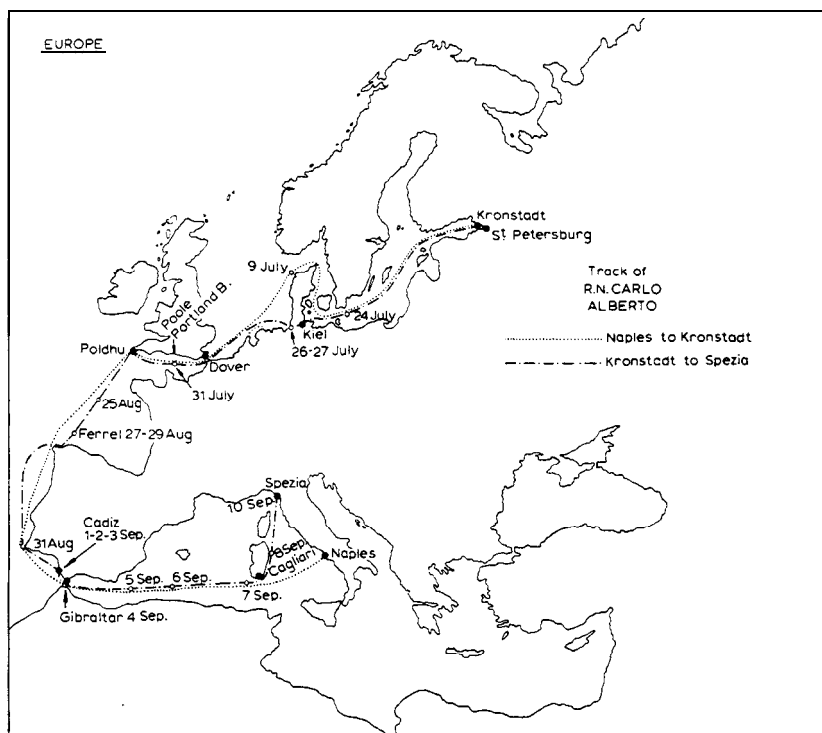

Fig. 16.

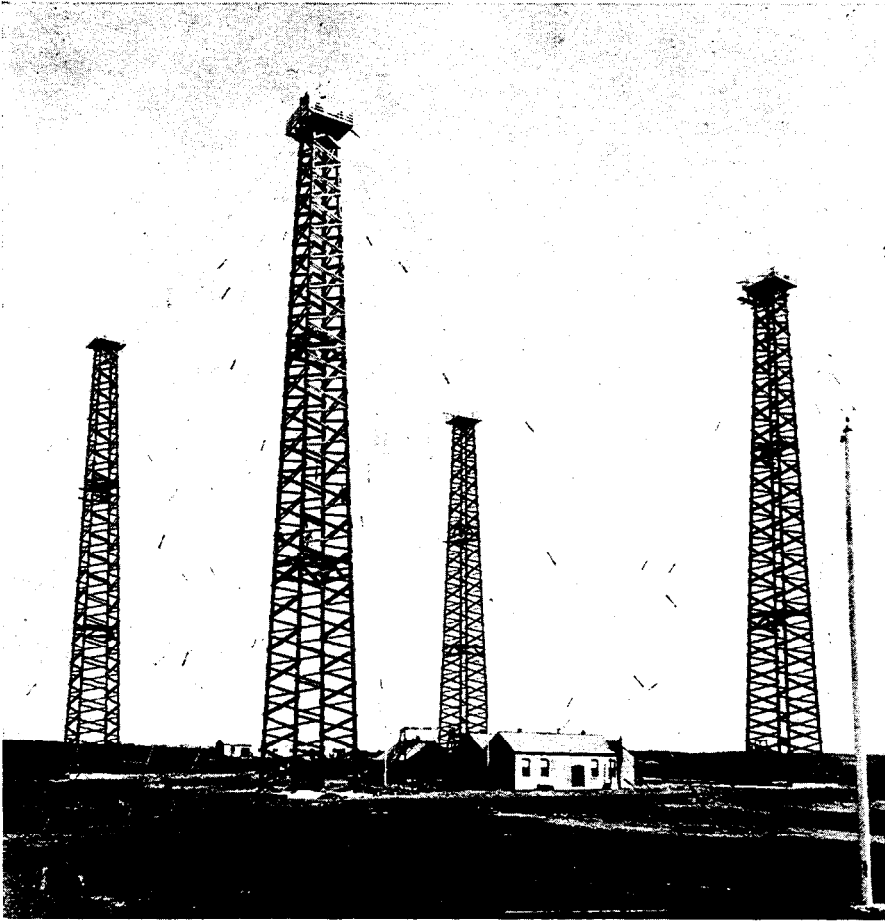

Fig. 17.

it has given me the opportunity of installing more efficient and up-to-date machinery.

The arrangements of elevated conductors or aerials which I have tried<sup>20</sup> during my long-distance tests, are shown in Figs. 19, 20 and 21.

The aerial shown in Fig. 21 consisted of a nearly vertical portion in the middle, 220 feet high, supported by four towers, and attached at the top to nearly horizontal wires, 200 in number and each 1,000 feet long, extending radially all round and supported at a height of 180 feet from the ground by an inner circle of 8, and an outer circle of 16 masts.

The natural period of oscillation of this aerial system gave a wavelength of 12,000 feet. Experiments were made with this arrangement in 1905 and with

a wavelength of 12,000 feet, signals, although very weak, could be received across the Atlantic by day as well as by night.

The system of aerial I finally adopted for the long-distance stations in England and Canada is shown in Fig. 22. This arrangement not only makes it possible to efficiently radiate and receive waves of any desired length, but it also tends to confine the main portion of the radiation to a given direction. The limitation of transmission to one direction is not very sharply defined, but the results obtained with this type of aerial are nevertheless exceedingly useful.

Many suggestions respecting methods for limiting the direction of radiating have been made by various workers, notable by Prof. F. Braun, Prof. Artom, and Messrs. Belhni and Tosi.

In a paper read before the Royal Society of London<sup>21</sup> in March 1906 I showed how it was possible by means of horizontal aerials to confine the emitted radiations mainly to the direction of their vertical plane, pointing away from their earthed end.

In a similar manner it is possible to locate the bearing or direction of a sending station.

The transmitting circuits at the long-distance stations are arranged in ac-

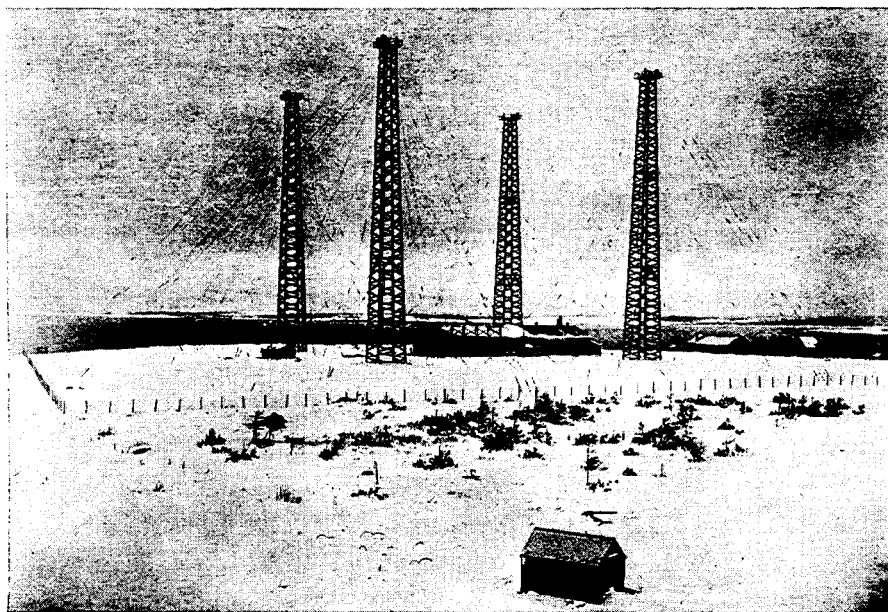

Fig. 18.

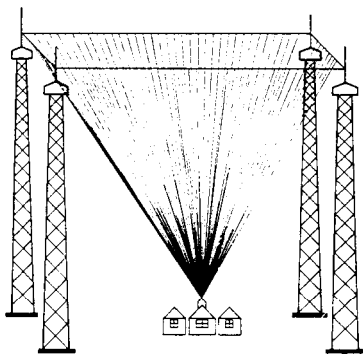

Fig. 19.

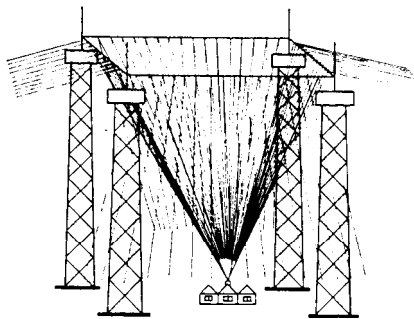

Fig. 20.

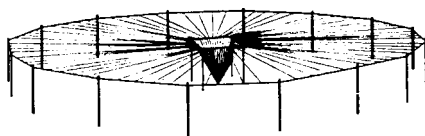

Fig. 21.

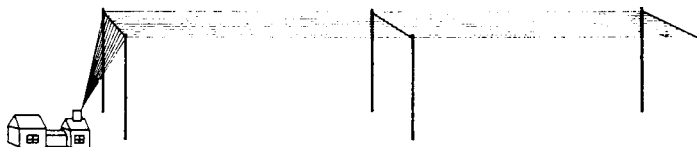

Fig. 22.

cordance with a comparatively recent system for producing continuous or slightly damped oscillations, which I referred to in a lecture before the Royal Institution of Great Britain on March 13, 1908.

An insulated metal disc *A* (see Fig. 23) is caused to rotate at a high rate of speed by means of an electric motor or steam turbine. Adjacent to this disc, which I will call the middle disc, are placed two other discs *C'* and *C''* which may be called polar discs, and which are also revolved. These polar discs have their peripheries very close to the surface or edges of the middle disc. The two polar discs are connected by rubbing contacts to the outer ends of two condensers *K*, joined in series, and these condensers are also connected through suitable brushes to the terminals of a generator which should be a high-tension continuous-current generator.

On the middle disc a suitable brush or rubbing contact is provided and between this contact and the middle point of the two condensers an oscillating circuit is inserted, consisting of a condenser *E* in series with an in-

ductance, which last is inductively connected with the radiating antennae.

The apparatus works probably in the following manner:

The generator charges the double condenser, making the potential of the discs, say  $C'$  positive and  $C''$  negative. The potential, if high enough will cause a discharge to pass across one of the gaps, say between  $C'$  and  $A$ . This charges the condenser  $E$  through the inductance  $F$ , and starts oscillations in the circuit. The charge of  $F$  in swinging back will jump from  $A$  to  $C''$ , the potential of which is of opposite sign to  $A$ , the dielectric strength between  $C'$  and  $A$  having meanwhile been restored by the rapid motion of the disc, driving away the ionized air.

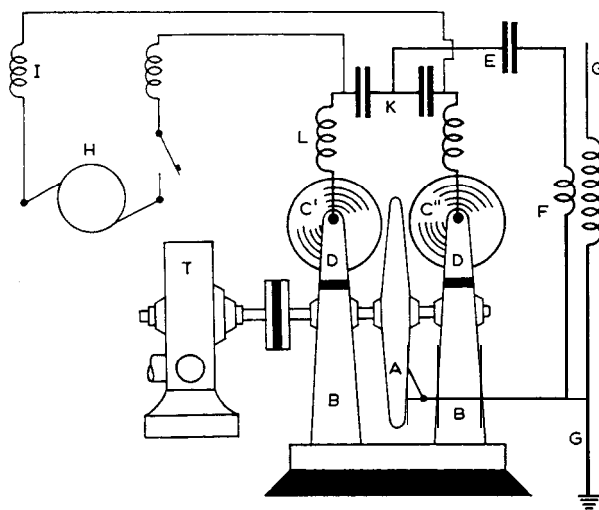

Fig. 23.

The condenser  $E$  therefore discharges and recharges alternatively in reverse directions, the same process going on so long as energy is supplied to the condensers  $K$  by the generator  $H$ .

It is clear that the discharges between  $C'$  and  $C''$  and  $A$  are never simultaneous as otherwise the centre electrode would not be alternatively positive and negative.

The best results have, however, been obtained by an arrangement as shown in Fig. 24, in which the active surface of the middle disc is not smooth, but consists of a number of regularly spaced copper knobs or pegs, at the ends of which the discharges take place at regular intervals. I have found that with this arrangement each tram of oscillations may have a decrement as low as 0.02.

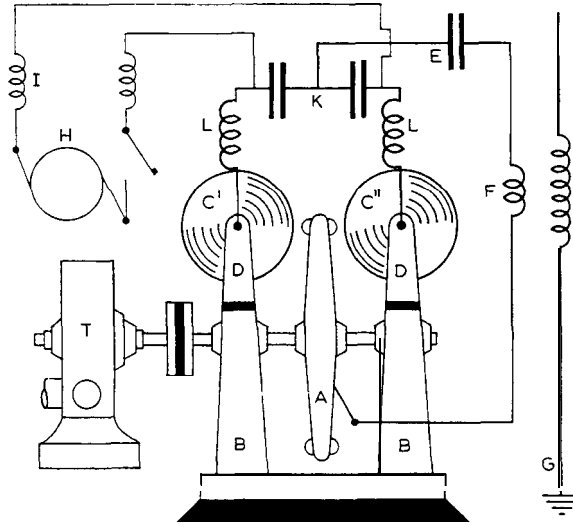

Fig. 24.

In this way it is also possible to cause the groups of oscillations radiated to reproduce a high and clear musical note in a receiver, thereby making it easy to differentiate between the signals emanating from the sending station and noises caused by atmospheric electrical discharges. By this method very efficient resonance can be also obtained in appropriately designed receivers.

With regard to the receivers employed, important changes have taken place. By far the larger portion of electric wave telegraphy was, until a few years ago, conducted by means of some form or other of coherer, or variable contact either requiring tapping or else self-restoring.

At the present day, however, I may say that at all the stations controlled by my Company my *magnetic receiver* (Fig. 25) is almost exclusively employed.<sup>22</sup>

This receiver is based on the decrease of magnetic hysteresis which occurs

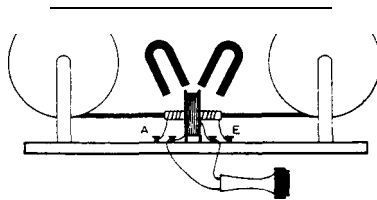

Fig. 25.

in iron when under certain conditions this metal is subjected to the effects of electrical waves of high frequency.

It has recently been found possible to increase the sensitiveness of these receivers, and to employ them in connection with a high-speed relay, so as to record messages at great speed.

A remarkable fact, not generally known, in regard to transmitters is, that none of the arrangements employing condensers exceed in efficiency the plain elevated aerial or vertical wire discharging to Earth through a spark gap, as used in my first experiments (see Figs. 2 and 3).

I have also recently been able to confirm the statement made by Prof. Fleming in his book *The Principles of Electric Wave Telegraphy*, 1906, page 555, that with a power of 8 watts in the aerial it is possible to communicate to distances of over 100 miles.

I have also found that by this method, when using large aerials, it is possible to send signals 2,000 miles across the Atlantic, with a smaller expenditure of energy than by any other method known to myself.

The only drawback to this arrangement is, that unless very large aerials are used, the amount of energy which can be efficiently employed is limited by the potential beyond which brush discharges and the resistance of the spark gap begin to dissipate a large proportion of the energy.

By means of spark gaps in compressed air and the addition of inductance coils placed between the aerial and earth, the system can be made to radiate very pure and slightly damped waves, eminently suitable for sharp tuning.

In regard to the general working of wireless telegraphy, the widespread application of the system and the multiplicity of the stations have greatly facilitated the observation of facts not easily explainable.

Thus it has been observed that an ordinary ship station, utilizing about 1/2 kilowatt of electrical energy, the normal range of which is not greater than 200 miles, will occasionally transmit messages across a distance of over 1,200 miles. It often occurs that a ship fails to communicate with a nearby station, but can correspond with perfect ease with a distant one.

On many occasions last winter, the S.S. "Caronia" of the Cunard Line, carrying a station utilizing about 1/2 kilowatt, when in the Mediterranean, off the coast of Sicily, failed to obtain communication with the Italian stations, but had no difficulty whatsoever in transmitting and receiving messages to and from the coasts of England and Holland, although these latter stations were considerably more than 1,000 miles away, and a large part of the continent of Europe and the Alps lay between them and the ship.



Although high power stations are now used for communicating across the Atlantic, and messages can be sent by day as well as by night, there still exist short periods of daily occurrence, during which transmission from England to America, or vice versa, is difficult. Thus in the morning and evening, when in consequence of the difference in longitude, daylight or darkness extends only part of the way across the ocean, the received signals are weak and sometimes cease altogether. It would almost appear as if electric waves in passing from dark space to illuminated space, and vice versa, were reflected in such a manner as to be deviated from their normal path.

It is probable that these difficulties would not be experienced in telegraphing over equal distances north and south, on about the same meridian, as in this case the passage from daylight to darkness would occur almost simultaneously over the whole distance between the two points.

Another curious result, on which hundreds of observations continued for years leave no further doubt, is that regularly, for short periods, at sunrise and sunset, and occasionally at other times, a shorter wave can be detected across the Atlantic in preference to the longer wave normally employed.

Thus at Clifden and Glace Bay when sending on an ordinary coupled circuit arranged so as to simultaneously radiate two waves, one 12,500 feet and the other 14,700 feet, although the longer wave is the one usually received at the other side of the ocean, regularly, about three hours after sunset at Clifden, and three hours before sunrise at Glace Bay, the shorter wave alone was received with remarkable strength, for a period of about one hour.

This effect occurred so regularly that the operators tuned their receivers to the shorter wave at the times mentioned, as a matter of ordinary routine.

With regard to the utility of wireless telegraphy there is no doubt that its use has become a necessity for the safety of shipping, all the principal liners and warships being already equipped, its extension to less important ships being only a matter of time, in view of the assistance it has provided in cases of danger.

Its application is also increasing as a means of communicating between outlying islands, and also for the ordinary purposes of telegraphic communication between villages and towns, especially in the colonies and in newly developed countries.

However great may be the importance of wireless telegraphy to ships and shipping, I believe it is destined to an equal position of importance in furnishing efficient and economical communication between distant parts of the world and in connecting European countries with their colonies and with

America. As a matter of fact, I am at the present time erecting a very large power station for the Italian Government at Coltano, for the purpose of communicating with the Italian colonies in East Africa, and with South America.

Whatever may be its present shortcomings and defects, there can be no doubt that wireless telegraphy - even over great distances - has come to stay, and will not only stay, but continue to advance.

If it should become possible to transmit waves right round the world, it may be found that the electrical energy travelling round all parts of the globe may be made to concentrate at the antipodes of the sending station. In this way it may some day be possible for messages to be sent to such distant lands by means of a very small amount of electrical energy, and therefore at a correspondingly small expense.

But I am leaving the regions of fact, and entering the regions of speculation, which, however, with the knowledge we have gradually gained on the subject, promise results both useful and instructive.

Not having the fortune of being conversant with the Swedish language, I have thought it best, although an Italian, to use the medium of the English language in delivering this address, as I know that English is more generally understood here than Italian.

1. G. Marconi, *Brit. Patent* No. 12,039, June 2, 1896.
2. *J. Inst. Elec. Engrs. (London)*, 28 (1899) 278.
3. See letter of Dr. Lodge in *The Times (London)*, June 22, 1897.
4. A. Slaby, *Die Funkentelegraphie*, Verlag von Leonhardt Simion, Berlin, 1897; see also A. Slaby, "The New Telegraphy", *The Century Magazine*, 55 (1898) 867.
5. *J. Inst. Elec. Engrs. (London)*, 28 (1899) 291.
6. *Brit. Patent* No. 12,326, June 1, 1898; *Brit. Patent* No. 6,982, April 1, 1899.
7. A. Blondel and G. Ferrie, "État actuel et Progrès de la Télégraphie sans Fil", read at the *Congrès International d'Électricité, Paris, 1900*; see also *J. Soc. Arts*, 49 (1901) 509.
8. *Brit. Patent* No. 7,777, April 26, 1900; see also *J. Soc. Arts*, 49 (1901) 510-11.
9. See Letter of Prof. J. A. Fleming in *The Times (London)*, October 4, 1900.
10. *Proc. Roy. Soc. (London)*, 72 (May 28, 1903).
11. J.A. Fleming, *The Principles of Electric Wave Telegraphy*, Longmans, Green & Co., London, 1906, p. 348.
12. J. Zenneck, *Ann. Physik*, [4], 23 (Sept. 1908) 846; *Physik. Z.*, 9 (1908) 50, 553.
13. *J. Soc. Arts*, 49 (1901) 512.
14. G. Marconi, lecture before the Royal Institution of Great Britain, June 13, 1902.

15. G. Marconi, "A Note on the Effect of Daylight upon the Propagation of Electromagnetic Impulses", *Proc. Roy. Soc. (London)*, 70 (June 12, 1902).
16. See also J. J. Thomson, "On Some Consequences, etc.", *Phil. Mag.*, [6] 4 (1902) 253.
17. See Ref. 11, p. 618.
18. *Riv. Marittima (Rome)*, October 1902.
19. G. Marconi, Paper read before the Royal Institution of Great Britain, March 3, 1905.
20. See also G. Marconi, Lecture before the Royal Institution of Great Britain, March 13, 1908.
21. G. Marconi, "On Methods whereby the Radiation of Electric Waves may be mainly confined, etc.", *Proc. Roy. Soc. (London)*, A 77 (1906).
22. G. Marconi, "Note on a Magnetic Detector of Electric Waves", *Proc. Roy. Soc. (London)*, 70 (1902) 341.