

# “SYNTHETIC METALS”: A NOVEL ROLE FOR ORGANIC POLYMERS

Nobel Lecture, December 8, 2000

by

ALAN G. MACDIARMID

Department of Chemistry, University of Pennsylvania, Philadelphia, Pennsylvania 19104-6323, USA.

## INTRODUCTION

An organic polymer that possesses the electrical, electronic, magnetic, and optical properties of a metal while retaining the mechanical properties, processibility, etc. commonly associated with a conventional polymer, is termed an “intrinsically conducting polymer” (ICP) more commonly known as a “synthetic metal”. Its properties are intrinsic to a “doped” form of the polymer. This class of polymer is completely different from “conducting polymers” which are merely a physical mixture of a nonconductive polymer with a conducting material such as a metal or carbon powder distributed throughout the material.

## THE CONCEPT OF DOPING

Conjugated organic polymers are either electrical insulators or semiconductors. Those that can have their conductivity increased by several orders of magnitude from the semiconductor regime are generally referred to as ‘electronic polymers’ and have become of very great scientific and technological importance since 1990 because of their use in light emitting diodes<sup>1</sup>. *Trans*-(CH)<sub>x</sub> and the emeraldine base form of polyaniline are used in Figure 1 to illustrate the increases in electrical conductivity of many orders of magnitude which can be obtained by doping. The conductivity attainable by an electronic polymer has very recently been increased an infinite number of times by the discovery of superconductivity in regioregular poly(3-hexylthiophene)<sup>2</sup>. Although this phenomenon was present only in a very thin layer of the polymer in a Field Effect (FET) configuration at a very low temperature (~2 K) it represents an historical quantum leap – superconductivity in an organic polymer!

Prior to the discovery of the novel protonic acid doping of polyaniline, during which the number of electrons associated with the polymer chain remain unchanged,<sup>3</sup> the doping of all conducting polymers had previously been accomplished by redox doping. This involves the partial addition (reduction)

## Conductivity increases with increased doping

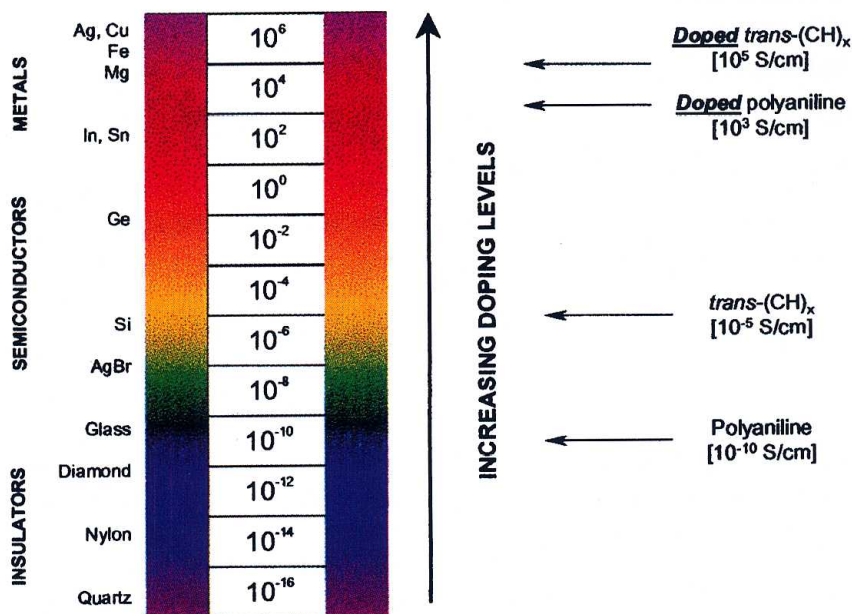

Figure 1. Conductivity of Electronic Polymers

or removal (oxidation) of electrons to or from the pi system of the polymer backbone<sup>4-6</sup>.

The concept of doping is the unique, central, underlying, and unifying theme which distinguishes conducting polymers from all other types of polymers<sup>7</sup>. During the doping process, an organic polymer, either an insulator or semiconductor having a small conductivity, typically in the range  $10^{-10}$  to  $10^{-5}$  S/cm, is converted to a polymer which is in the 'metallic' conducting regime ( $\sim 1$  to  $10^4$  S/cm). The controlled addition of known, usually small ( $\leq 10$  per cent) non-stoichiometric quantities of chemical species results in *dramatic* changes in the electronic, electrical, magnetic, optical, and structural properties of the polymer. Doping is reversible to produce the original polymer with little or no degradation of the polymer backbone. Both doping and undoping processes, involving dopant counterions which stabilize the doped state, may be carried out chemically or electrochemically<sup>6</sup>. Transitory doping by methods which introduce no dopant ions are also known<sup>8</sup>.

By controllably adjusting the doping level, a conductivity anywhere between that of the non-doped (insulating or semiconducting) and that of the fully doped (highly conducting) form of the polymer can be easily obtained. Conducting blends of a (doped) conducting polymer with a conventional polymer (insulator), whose conductivity can be adjusted by varying the relative proportions of each polymer, can be made<sup>9</sup>. This permits the optimization of the best properties of each type of polymer.

Since the initial discovery in 1977, that polyacetylene  $(\text{CH})_x$ , now commonly known as the prototype conducting polymer, could be *p*- or *n*-doped, either chemically or electrochemically to the metallic state<sup>7,10,11</sup>, the development of the field of conducting polymers has continued to accelerate at an unexpectedly rapid rate and a variety of other conducting polymers and their derivatives have been discovered<sup>5,6</sup>. This rapid growth rate has been stimulated by the field's fundamental synthetic novelty and importance to a cross-disciplinary section of investigators – chemists, electrochemists, biochemists, experimental and theoretical physicists, and electronic and electrical engineers and to important technological emerging applications of these materials.

In the “doped” state, the backbone of a conducting polymer consists of a delocalized pi system. In the undoped state, the polymer may have a conjugated backbone such as in *trans*- $(\text{CH})_x$  which is retained in a modified form after doping, or it may have a non-conjugated backbone, as in polyaniline (leucoemeraldine base form), which becomes truly conjugated only after *p*-doping, or a non-conjugated structure as in the emeraldine base form of polyaniline which becomes conjugated only after protonic acid doping.

## REDOX DOPING

All conducting polymers (and most of their derivatives), e.g. poly-(para-phenylene),  $\text{+}\langle\text{C}_6\text{H}_4\rangle\text{+}$ , poly(phenylenevinylene),  $\text{+}\langle\text{C}_6\text{H}_4\text{-CH=CH}\rangle\text{+}$ , polypyrrole,  $\text{+}\langle\text{N}\rangle\text{+}$ , polythiophene,  $\text{+}\langle\text{S}\rangle\text{+}$ , polyfuran,  $\text{+}\langle\text{O}\rangle\text{+}$ , poly(heteroaromatic vinylenes)

$\text{+}\langle\text{Y-CH=CH}\rangle\text{+}$  (where Y=NH, NR, S and O); polyaniline,  $\text{+}\langle\text{C}_6\text{H}_4\text{-NH}\rangle\text{+}$ ; etc., undergo either *p*- and/or *n*-redox doping by chemical and/or electrochemical processes during which the number of electrons associated with the polymer backbone changes<sup>5,6</sup>. Selected examples of the different types of doping are presented below.

*Chemical and electrochemical p-doping.* P-doping, i.e. partial oxidation of the  $\pi$  backbone of an organic polymer, was first discovered by treating *trans*- $(\text{CH})_x$  with an oxidizing agent such as iodine<sup>7</sup>, viz.,

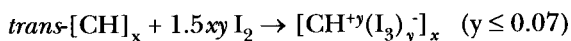

This process was accompanied by an increase in conductivity from  $\sim 10^{-5}$  S/cm to  $\sim 10^3$  S/cm. If the polymer is stretch-oriented five- to six-fold before doping, conductivities parallel to the direction of stretching up to  $\sim 10^5$  S/cm can be obtained<sup>5,6</sup>.

Approximately 85% of the positive charge is delocalized over 15 CH units (depicted below, for simplicity over only five units) to give a positive soliton, viz.,

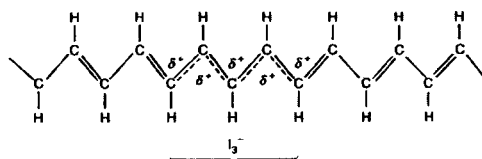

*P*-doping can also be accomplished by electrochemical anodic oxidation by immersing a *trans*-(CH)<sub>x</sub> film in, e.g. a solution of LiClO<sub>4</sub> dissolved in propylene carbonate and attaching it to the positive terminal of a DC power source, the negative terminal being attached to an electrode also immersed in the solution<sup>10</sup>, viz.,

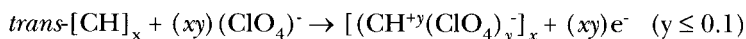

*Chemical and electrochemical n-doping.* *N*-doping, i.e. partial reduction of the backbone pi system of an organic polymer, was also discovered using *trans*-(CH)<sub>x</sub> by treating it with a reducing agent such as liquid sodium amalgam or preferably sodium naphthalide<sup>7</sup>, viz.,

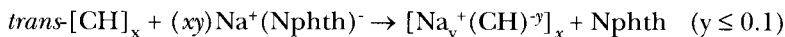

The antibonding π\* system is partially populated by this process which is accompanied by an increase in conductivity of ~10<sup>3</sup> S/cm.

*N*-doping can also be carried out by electrochemical cathodic reduction<sup>11</sup> by immersing a *trans*-(CH)<sub>x</sub> film in, e.g. a solution of LiClO<sub>4</sub>, dissolved in tetrahydrofuran and attaching it to the negative terminal of a DC power source, the positive terminal being attached to an electrode also immersed in the solution, viz.,

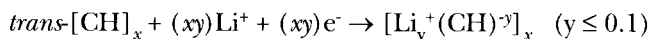

In all chemical and electrochemical p- and n-doping processes discovered for (CH)<sub>x</sub> and for the analogous processes in other conducting polymers, counter 'dopant' ions are introduced which stabilize the charge on the polymer backbone. In each case, spectroscopic signatures, e.g. those of solitons, polarons, bipolarons, etc., are obtained characteristic of the given charged polymer. However, the doping phenomena concept extends considerably beyond that given above to 'doping' processes where no counter dopant ion is involved, i.e. to doping processes in which transitory 'doped' species are produced, which have similar spectroscopic signatures to polymers containing dopant ions. Such type of doping can provide information not obtainable by chemical or electrochemical doping. Examples of such types of redox doping which can be termed 'photo-doping' and 'charge-injection doping' are given below.

## DOPING INVOLVING NO DOPANT IONS

*Photo-doping.* When *trans*-(CH)<sub>x</sub> for example, is exposed to radiation of energy greater than its band gap, electrons are promoted across the gap and the polymer undergoes 'photo-doping'. Under appropriate experimental conditions, spectroscopic signatures characteristic of, for example, solitons can be observed<sup>12</sup>, viz.,

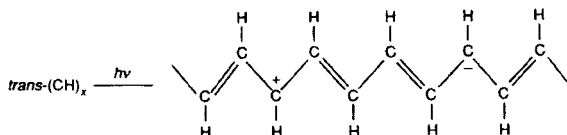

The positive and negative solitons are here illustrated diagrammatically for simplicity as residing only on one CH unit; they are actually delocalized over  $\sim 15$  CH units. They disappear rapidly due to recombination of electrons and holes when irradiation is discontinued. If a potential is applied during irradiation, then the electrons and holes separate and photoconductivity is observed.

*Charge-injection doping.* Charge-injection doping is most conveniently carried out using a metal/insulator/semiconductor (MIS) configuration involving a metal and a conducting polymer separated by a thin layer of a high dielectric strength insulator. It was this approach, which resulted in the observance of superconductivity in a polythiophene derivative, as described previously. Application of an appropriate potential across the structure can give rise, for example, to a surface charge layer, the 'accumulation' layer which has been extensively investigated for conducting polymers<sup>8,13</sup>. The resulting charges in the polymer, e.g.  $(\text{CH})_x$  or poly(3-hexylthiophene), are present without any associated dopant ion. The spectroscopic properties of the charged species so formed can therefore be examined in the absence of dopant ion. Using this approach, spectroscopic studies of  $(\text{CH})_x$  show the signatures characteristic of solitons and the mid-gap absorption band observed in the chemically and electrochemically doped polymer. However, coulombic interaction between charge on the chain and dopant ion is a very strong interaction and one that can totally alter the energetics of the system.

## NON-REDOX DOPING

This type of doping differs from redox doping described above in that the number of electrons associated with the polymer backbone does not change during the doping process.

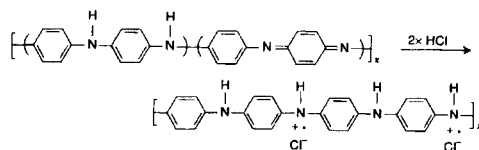

The energy levels are rearranged during doping. The emeraldine base form of polyaniline was the first example of the doping of an organic polymer to a highly conducting regime by a process of this type to produce an environmentally stable polysemiquinone radical cation. This was accomplished by treating emeraldine base with aqueous protonic acids and is accompanied by a nine to ten order of magnitude increase in conductivity (up to  $\sim 3$  S/cm) to produce the protonated emeraldine base<sup>14-16</sup>. Protonic acid doping has subsequently been extended to systems such as poly(heteroaromatic vinylenes)<sup>17</sup>.

## THE POLYANILINES

The polyanilines refer to a very important class of electronic/conducting polymers. They can be considered as being derived from a polymer, the base form of which has the generalized composition:

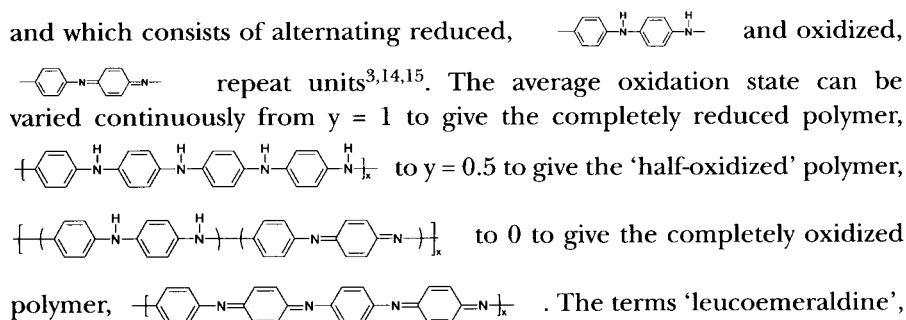

'emeraldine', and 'pernigraniline' refer to the different oxidation states of the polymer where  $y = 1, 0.5,$  and  $0,$  respectively, either in the base form, e.g. emeraldine base, or in the protonated salt form, e.g. emeraldine hydrochloride<sup>3,14,15</sup>. In principle, the imine nitrogen atoms can be protonated in whole or in part to give the corresponding salts, the degree of protonation of the polymeric base depending on its oxidation state and on the pH of the aqueous acid. Complete protonation of the imine nitrogen atoms in emeraldine base by aqueous HCl, for example, results in the formation of a delocalized polysemiquinone radical cation<sup>3,15,18</sup> and is accompanied by an increase in conductivity of  $\sim 10^{10}$ .

The partly protonated emeraldine hydrochloride salt can be synthesized easily either by the chemical or electrochemical oxidative polymerization of aniline<sup>3,14,15</sup>. It can be deprotonated by aqueous ammonium hydroxide to give emeraldine base powder (a semiconductor).

## ALLOWED OXIDATION STATES

As can be seen from the generalized formula of polyaniline base,

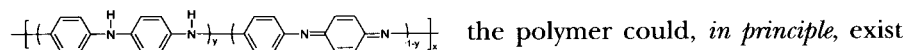

in a continuum of oxidation states ranging from the completely reduced material in the leucoemeraldine oxidation state,  $y = 1$  to the completely oxidized material in the pernigraniline oxidation state,  $y = 0$ . However, we have shown<sup>16</sup> that at least in N-methyl-2-pyrrolidinone (NMP) solution in the range  $y = 0$  to  $y = 0.5$  (emeraldine oxidation state) only two chromophores are present, characteristic of  $y = 1$  and  $y = 0.5$  species and that all intermediate oxidation states consist, at the molecular level, only of *mixtures* of the chromophores characteristic of these two states.

Since most of the properties of polyaniline of interest are concerned with the solid state, we have carried out a series of studies in the solid state which

show that the same phenomenon is true in the  $y = 1$  to  $y = 0.5$  oxidation state range and in the  $y = 0.5$  to  $y = 0$  oxidation state range. Within each of these ranges all intermediate oxidation states consist, at the molecular level, only of mixtures of the chromophores characteristic of the two states defining the beginning and end of each range<sup>19,20</sup>.

## DOPING

Polyaniline holds a special position amongst conducting polymers in that its most highly conducting doped form can be reached by two completely different processes – protonic acid doping and oxidative doping. Protonic acid doping of emeraldine base units with, for example 1M aqueous HCl results in complete protonation of the imine nitrogen atoms to give the fully protonated emeraldine hydrochloride salt<sup>14,15</sup>:

As shown in Figure 2, protonation is accompanied by a 9 to 10 order of magnitude increase in conductivity reaching a maximum in  $\sim 1$  M aqueous HCl.

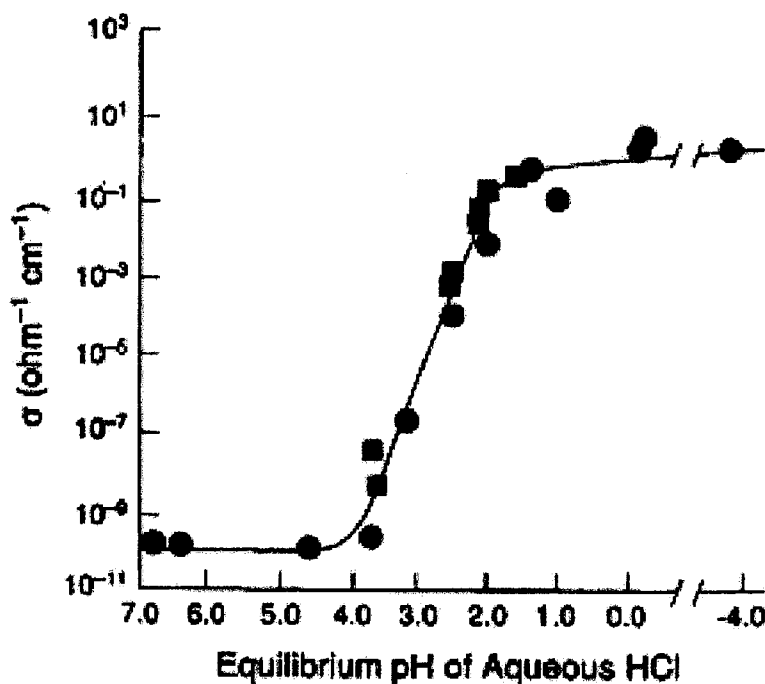
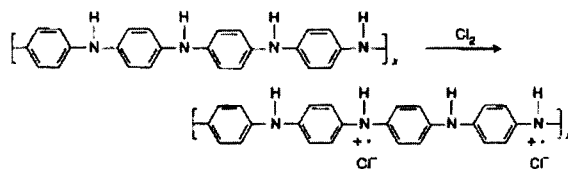

Figure 2. Conductivity of emeraldine base as a function of pH of HCl dopant solution as it undergoes protonic acid doping ( $\bullet$  and  $\blacksquare$  represent two independent series of experiments)<sup>14,15</sup>.

The same doped polymer can be obtained by chemical oxidation (p-doping) of leucoemeraldine base<sup>3</sup>. This actually involves the oxidation of the  $\sigma/\pi$  system rather than just the  $\pi$  system of the polymer as is usually the case in p-type doping. Its reaction with a solution of chlorine in carbon tetrachloride proceeds to give emeraldine hydrochloride:



## NANOELECTRONICS

The basic purpose of this research is to blend the now well-established field of electronic/conducting polymers with the new, emerging field of nanoscience, by electrostatic fabrication ("electrospinning") to produce "nanoelectronics" – electronic junctions and devices significantly smaller than the diameter of a human hair (~50,000 nm). It is commonly accepted that a nanomaterial is defined as one consisting of a substance or structure which exhibits at least one dimension of less than 100 nm (0.1  $\mu\text{m}$ )<sup>21</sup>.

Our objectives were: (i) to develop a method by which nanofibers (diameter < 100 nm) of organic polymers could be controllably and reproducibly fabricated such that in one given preparation, all fibers would have a diameter < 100 nm *and* (ii) to reproducibly and controllably fabricate, for the first time, nanofibers of electronic polymers (in their semiconducting and metallic regimes) *and/or* their blends in conventional organic polymers for the purpose of ascertaining their applicability in the fabrication of nanoelectronic devices.

We have made substantial progress in achieving these objectives by using a relatively little known, simple, convenient and inexpensive "electrospinning" method<sup>22–27</sup>. We have previously reported<sup>23</sup> fabrication of the first conducting polymer fibers (diameter ~950 nm to 2,100 nm) of polyaniline doped with *d,l* camphorsulfonic acid (Pan.HCSA) as a blend in polyethylene oxide (PEO). We were surprised to find that an electronic polymer, such as polyaniline, which might have been expected to be more susceptible to degradation than most conventional organic polymers, survived, without observable chemical or physical change, following the 25,000 V electrospinning fabrication process in air at room temperature.

*Electrospinning.* The electrospinning technique involves a simple, rapid, inexpensive, electrostatic, non-mechanical method in which a polymer solution in a variety of different possible common solvents, including water, is placed in a hypodermic syringe or in a glass pipette, at a fixed distance (5–30 cm) from a metal cathode<sup>24</sup>. The positive (anode) terminal of a variable high voltage transformer is attached to the metal tip of the hypodermic syringe or to a wire inserted into the polymer solution in the glass pipette, the negative terminal being attached to the metal cathode. The tip of the syringe can be placed vertically over the cathode or at any other convenient angle to it. When the voltage applied between the anode and cathode reaches a critical value, ~14,000 V at a ~20 cm separation, the charge overcomes the surface tension of the deformed drop of the polymer solution on the tip of the syringe and a jet is produced. Since the polymer molecules all bear the same



(positive) charge, they repel each other while traveling in air during a few milliseconds from the anode to cathode and become separated<sup>25</sup>. At the same time, evaporation of the solvent molecules occurs rapidly. Evaporation of solvent is also enhanced because the similarly-charged (positive) solvent molecules repel each other. Under appropriate conditions, dry, meters-long fibers accumulate on the surface of the cathode resulting in a non-woven mesh of nano- to micron diameter fibers depending on experimental parameters (Figure 3).

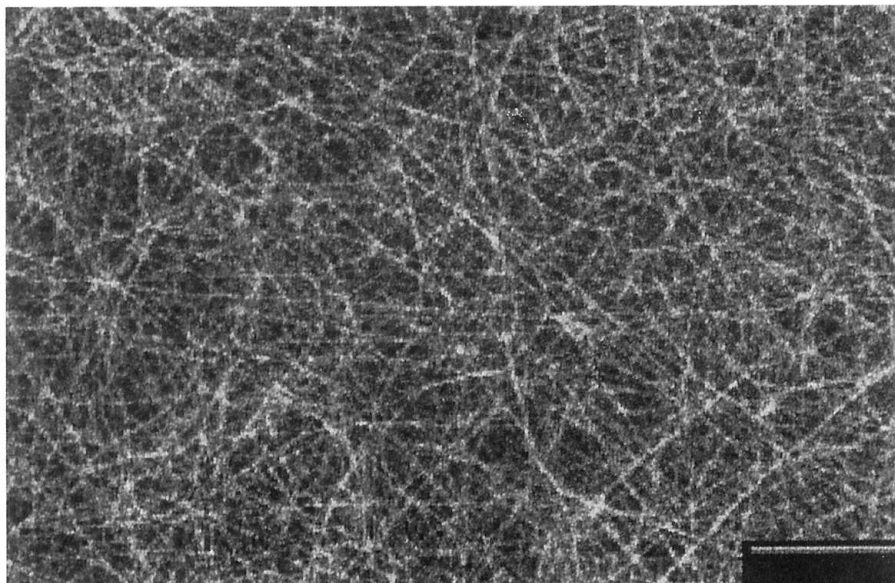

Figure 3. 50 wt% Nanofiber blend of PAn.HCSA fabricated from 2 wt% PAn.HCSA and 2 wt% PEO from chloroform solution at 25,000 V (anode/cathode separation, 25 cm). Scale bar: 100,000 nm.

*Nanofiber Fabrication.* Since the submicron fibers (500–1,600 nm) obtained in our initial work<sup>23</sup> were not classifiable as true “nanofibers,” our immediate objective was to break the “nanotechnology barrier” and to consistently and reproducibly fabricate true nanofibers (diameter <100 nm) of an organic polymer. This was accomplished (see Figure. 4) using an 8 wt% solution of polystyrene (Mw 212,400) in tetrahydrofuran at a potential of 20,000 V between the anode and cathode which were separated by 30 cm. The fibers were collected as a mat on an aluminum target and were found to have diameter characteristics: average, 43.1 nm; maximum, 55.0 nm; minimum, 26.9 nm. Other studies involving polystyrene gave fibers whose diameters were consistently < 100 nm; average, 30.5 nm; maximum, 44.8 nm; minimum, 16.0 nm. It might also be noted that the above 16 nm fiber is only ~30 polystyrene molecules wide. It is also of interest to note that a 16 nm fiber such as the one mentioned above lies well within the ~ 4–30 nm diameter range of multi-walled carbon nanotubes<sup>26</sup>.

*Electronic Polymer Fibers.* By using a previously observed method for producing polyaniline fibers<sup>27</sup> we have prepared highly-conducting sulfuric acid-

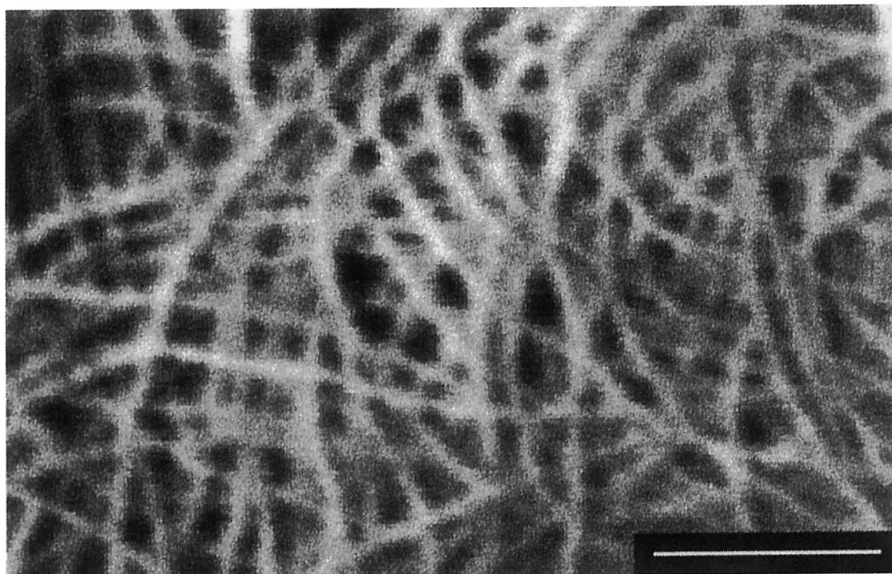

Figure 4. Electrospun fibers of polystyrene (see text). Scale bar: 1000 nm. The extended length of the fibers is clearly visible.

doped polyaniline fibers (diameters: average, 139 nm; maximum, 275 nm; minimum, 96nm) by placing a ~ 20 wt% solution of polyaniline in 98% sulfuric acid in a glass pipette with the tip ~ 3 cm above the surface of a copper cathode immersed in pure water at 5,000 V potential difference. The fibers collect in or on the surface of the water. The conductivity of a single fiber was ~ 0.1 S/cm, as expected since partial fiber de-doping occurred in the water cathode. The diameter and length of the fibers appear (Figure 5) to be sen-

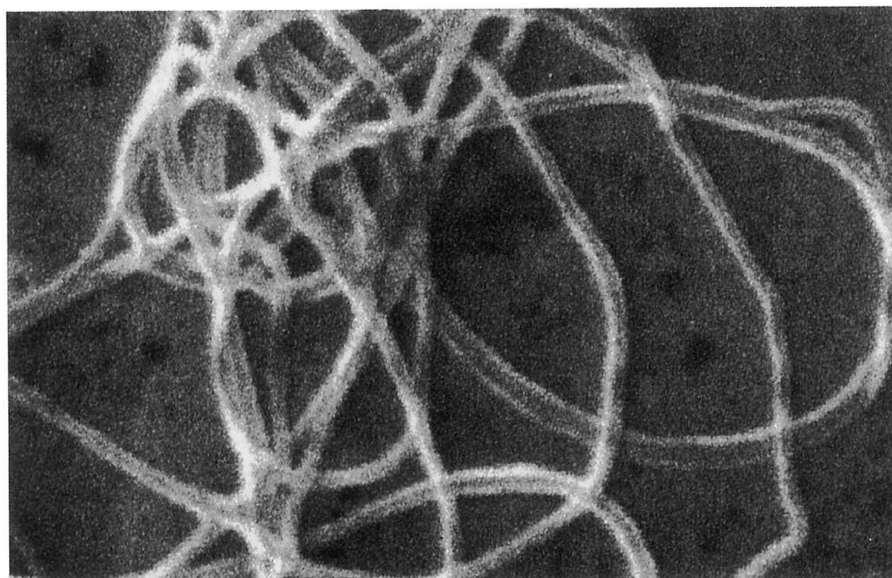

Figure 5. 100% polyaniline fiber with an average diameter of 139 nm.

sitive to the nature of the polyaniline used. No great difficulty is foreseen in producing fibers < 100 nm diameter.

It is relatively easy to prepare conducting blends of PAn.HCSA in a variety of different conventional polymers such as polyethylene oxide, polystyrene, polyacrylonitrile, etc. For example, ~ 20 wt% blends of PAn.HCSA in polystyrene (Mw 114,200) are obtained by electrospinning a chloroform solution; fiber diameter characteristics: average, 85.8 nm; maximum, 100.0 nm; minimum 72.0 nm. These fibers are sufficiently electrically conductive that their SEMs may be recorded without the necessity of applying a gold coating.

Separate, individual nanofibers can be collected and examined if so desired. An appropriate substrate – glass slide, silicon wafer or loop of copper wire, etc. – is held between the anode and cathode at a position close to the cathode for a few seconds to collect individual fibers (see Figure 6).

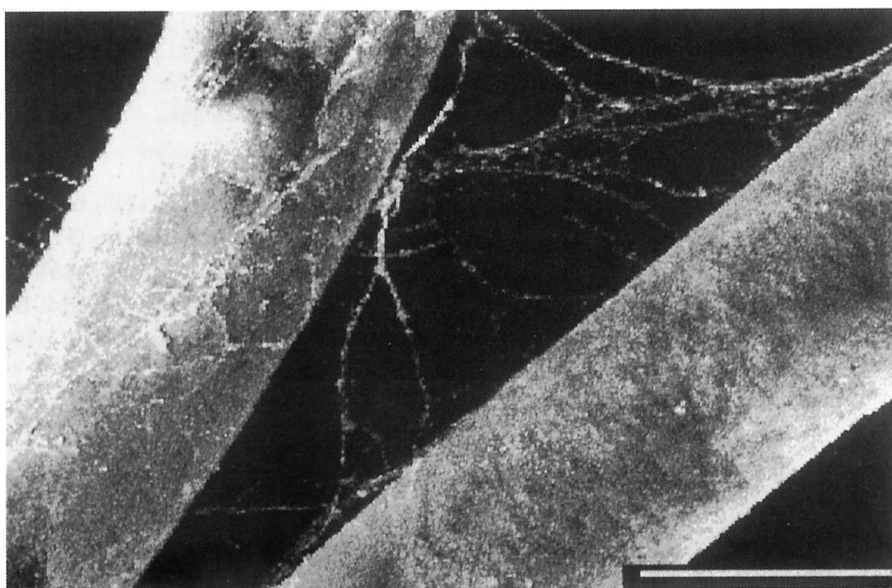

Figure 6. Polystyrene fibers collected on a bent copper wire (magnification 33x) and subsequently coated with a thin layer of polypyrrole by *in situ* deposition from aqueous solution. Scale bar: 1 mm.

Current/voltage (I/V) curves are given in Figure 7 for a single 419 nm diameter fiber (Fiber 1) and for a ~600nm diameter fiber (Fiber 2) of a blend of 50 wt% PAn.HCSA and polyethylene oxide collected on a silicon wafer coated with a thin layer of SiO<sub>2</sub>. Two gold electrodes separated by 60.3 μm are deposited on the fiber after its deposition on the substrate.

*Nanofibers as Substrates.* The large surface to volume ratio offered by nanofibers makes them excellent, potentially useful substrates for the fabrication of coaxial nanofibers consisting of superimposed layers of different materials. Catalysts and electronically active materials can be deposited on them by chemical, electrochemical, solvent, chemical vapor, or other means, for use in nanoelectronic junctions and devices.

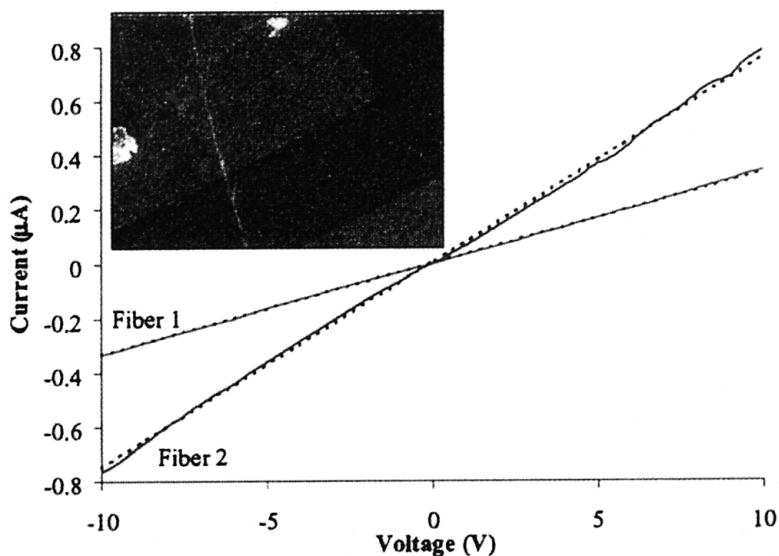

Figure 7. Current/voltage curves of 50 wt% PAn.HCSA/PEO blend nanofiber.

We have found, for example, that polyacrylonitrile nanofibers can be easily and evenly coated with a 20–25 nm layer of conducting polypyrrole (Figure 8) by immersion in an aqueous solution of polymerizing polypyrrole<sup>28</sup>. Analogously, we have found that electroless deposition of metals can also be performed. Polyacrylonitrile fibers, for example, can be evenly coated with gold by electroless deposition<sup>29</sup>.

*Carbon Nanofibers.* As previously reported<sup>30</sup> polyacrylonitrile fibers may be

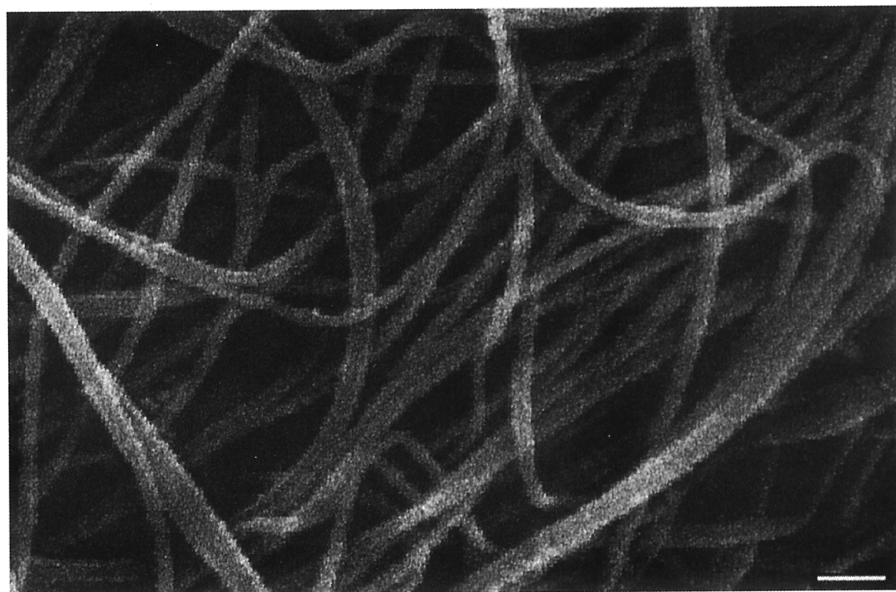

Figure 8. SEM of conducting polypyrrole coated polyacrylonitrile nanofibers. Scale bar: 1000 nm.

thermally converted to carbon nanofibers with some shrinkage. We have similarly converted polyacrylonitrile nanofibers to carbon nanofibers.

In summary, electronic polymers have been used for the past 20 years to produce rectifying diodes by Schottky and p/n junctions, transistors, light-emitting devices, photovoltaic cells, rechargeable batteries, etc<sup>1</sup>. Now, the ability to fabricate nanofibers of electronic polymers which are only a few molecules thick suggests the emergence of a field of nanoelectronics whereby the electronic properties of such nanofibers can be exploited for technological purposes.

### LINE PATTERNING OF CONDUCTING POLYMERS<sup>30</sup>

One of the exciting challenges of the first part of this century will be the development of low-cost disposable plastic/paper electronic devices<sup>31-33</sup>. Conventional inorganic conductors, such as metals, and semiconductors, such as silicon, commonly require multiple etching and lithographic steps in fabricating them for use in electronic devices. The number of processing steps and chemical etching steps involved limit the minimum price and therefore their applicability in disposable electronics. On the other hand, conducting polymers combine many advantages of plastics, e.g. flexibility and processing from solution, with the additional advantage of conductivity either in the metallic or semiconducting regimes; however, the lack of simple methods to obtain inexpensive conductive polymer shapes/patterns limit many applications. We here describe a novel, simple and cheap method to prepare patterns of conducting polymers by a process which we term, "Line Patterning".

Line Patterning uses the difference in selected physical and/or chemical properties between a substrate and insulating lines which have been printed on it by a conventional copying or printing process towards a fluid (or vapor) to which they are both simultaneously exposed. The substrate and printed lines react differently or at different rates with the fluid (or vapor) to which they have been exposed. This results in a non-uniform deposition on the substrate as compared to the printed lines. If the fluid contains a conducting polymer, which remains as a film after evaporation of the solvent, a pattern of conducting polymer results. A pattern is first designed on a computer and is then printed on, for example, an overhead transparency using a standard, non-modified office laser printer.

The printed (insulating) lines can be easily removed, if necessary, in a few seconds by ultrasonic treatment in toluene, dissolving the printed lines and leaving a clean pattern of deposited material on the substrate whose shape was originally defined by the now non-existent printed lines. Line Patterning has the following advantages: no photolithography is involved; no printing of conducting polymer is involved; it uses only, e.g., a standard office laser printer, which is not modified in any way; commercially available flexible, transparent plastic or paper substrates can be used; solutions of commercially available conducting or non-conducting polymers can be used from which the polymers may be deposited on substrates; it is inexpensive; rapid develop-

ment of customized patterns (within hours) from a computer designed pattern to product is routine.

We have exploited, for example, the observation that a commercial dispersion of poly-3,4-ethylenedioxythiophene (PEDOT, "Baytron P", Bayer Corp.) wets commercial plastic overhead transparency, but not the lines printed on it by a standard office laser printer. A coating of PEDOT can be applied by a roller and after evaporation of the solvent; the printed lines can be easily and cleanly removed by sonication, leaving only the conducting polymer on the transparency.

Two electrodes were prepared in this way, each containing 25 lines/inch. A drop of a standard commercial Polymer Dispersed Liquid Crystal Display (PDLC)<sup>34</sup> mixture containing an optical adhesive and 15  $\mu\text{m}$  spacer spheres was placed on the center of each electrode. The second electrode was placed on top at an angle of  $90^\circ$  to the first. This resulted in a  $(25 \times 25)$ , i.e. 625 pixels/sq. inch matrix. [Figure 9] Exposure to U/V light for a few minutes resulted in polymerization of the mixture to bind the two electrodes together and to produce a free-standing working PDLC liquid crystal display device. When an electrode pattern of 100 lines/inch was used a working 10,000 pixel/sq. inch display was produced.

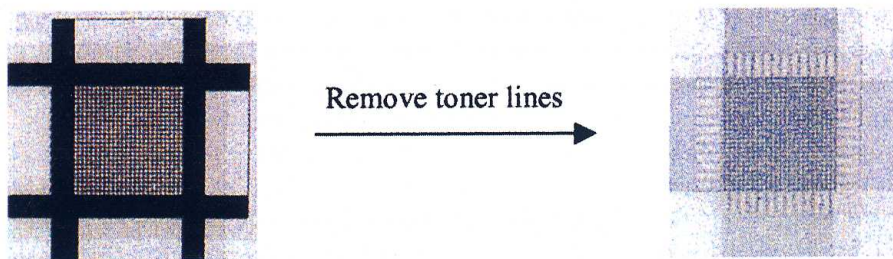
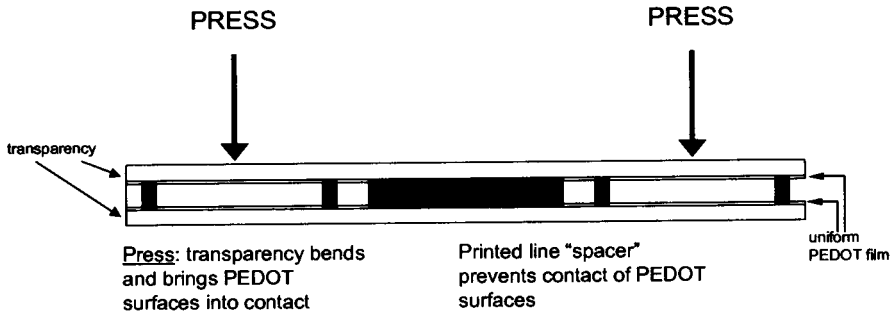

Figure 9. 625 pixel PDLC Liquid Crystal Display.

We have devised a novel way of separating conducting polymer circuits from each other by making use of the height ( $\sim 4\text{--}5 \mu\text{m}$ ) of the printed toner lines, using a standard office printer, above the substrate e.g. on an overhead transparency. This is illustrated [Figure 10 and 11] by a "push button" switch to open and close a simple electrical circuit. A combination of two patterned transparencies where the two adjacent conductive areas are electrically separated from each other by two  $\sim 4\text{--}5 \mu\text{m}$  non-conductive printed toner lines is obtained by placing the printed lines on top of each other as shown in Figures 11 and 12. Depression of the areas labeled "PRESS" causes the upper transparency to bend. This electrically connects the conducting PEDOT surfaces. When released, the transparency film returns back to its original position, thus breaking the electrical circuit.

The two-dimensional conducting polymer circuits may be readily converted to three-dimensional circuits by two different methods as shown in Figure 12 simply by (i) stapling two two-dimensional circuits together using a common office desk stapler. The metal staple joins together electrically the con-



■ represents  $(2 \times \sim 4.5 \mu\text{m} = \sim 9 \mu\text{m})$  "spacer" between the two conducting PEDOT surfaces.

Figure 10. A Simple Electronic Circuit ("push button" switch).

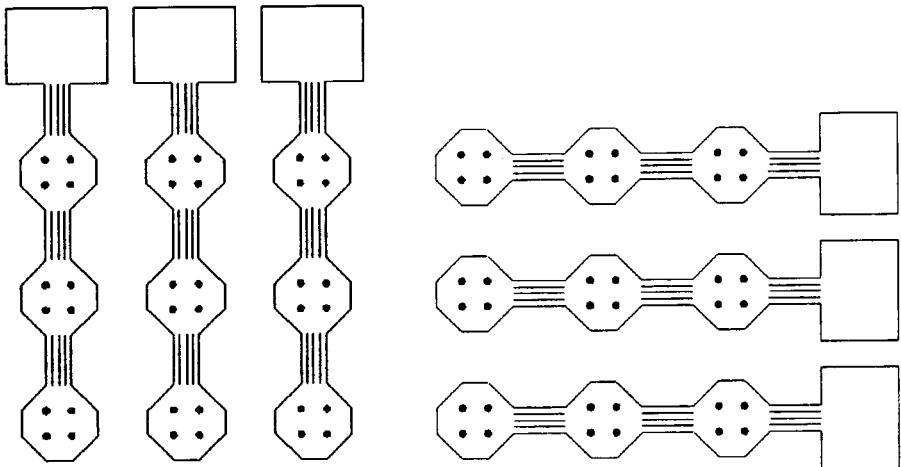

Figure 11. "Push button" switch.

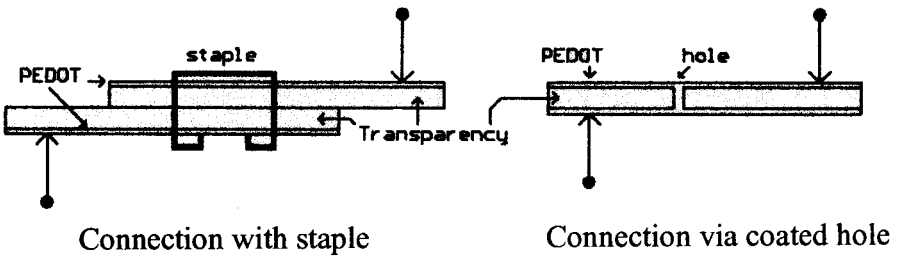

Figure 12. Three-Dimensional Connections.

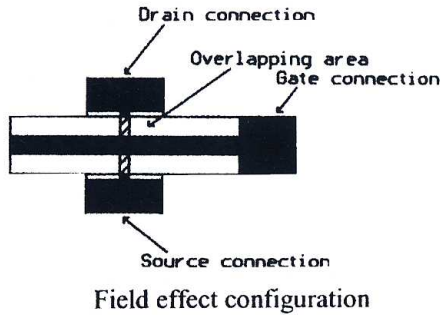
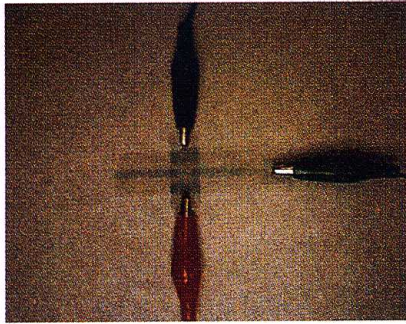

Figure 13. Field-Effect Doped "PEDOT".

ducting polymer areas on two different substrates *or* (ii) making a pinhole through the sheets, as shown, before applying the PEDOT solution. Some of the solution enters the pinhole and joins together electrically the conducting surfaces on the two different circuits.

We have recently observed a curious field effect which thin films of PEDOT exhibit when exposed to a positive gate potential in an FET configuration as shown in Figure 13. A source/drain electrode and a gate electrode are prepared by Line Patterning and are covered by a thin layer of PEDOT as described above. A drop of the optical adhesive containing spacer spheres described above is placed on the source/drain electrode upon which the gate

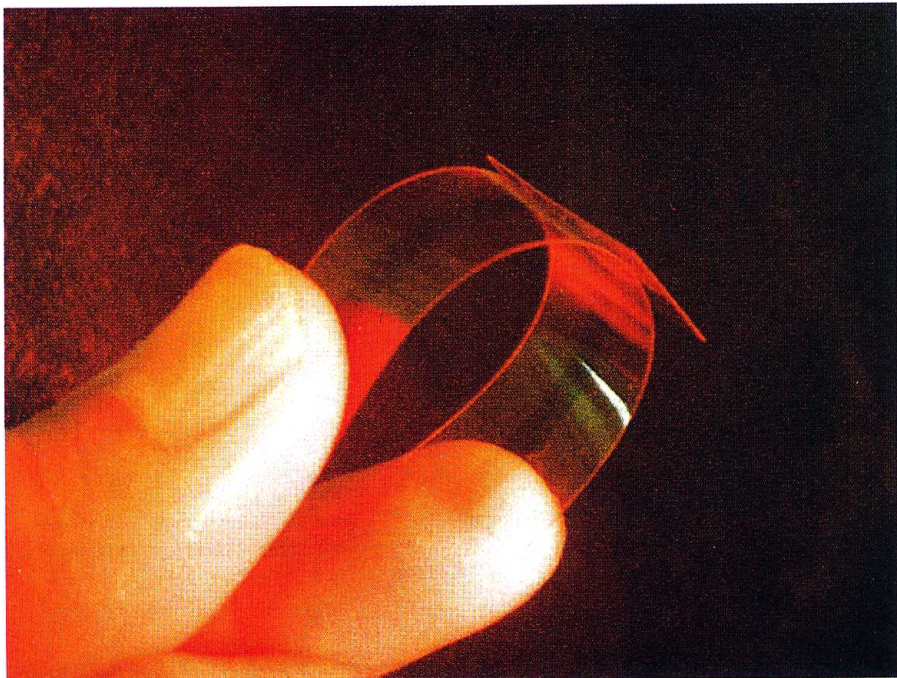

Figure 14. FET-type device.



electrode is then placed at  $90^\circ$ . The two electrodes are manually squeezed together and the optical adhesive is polymerized by exposure to U/V light as was done for the PDLC liquid crystal display described previously. Several thousand of these interconnected transistor-type devices could be readily fabricated per square in. by the Line Patterning process, if it were considered desirable. The free-standing, flexible device shown in Figures 13 and 14 is produced.

The device exhibits the same general reversible features commonly associated with a field effect transistor (FET) as shown in Figure 15.

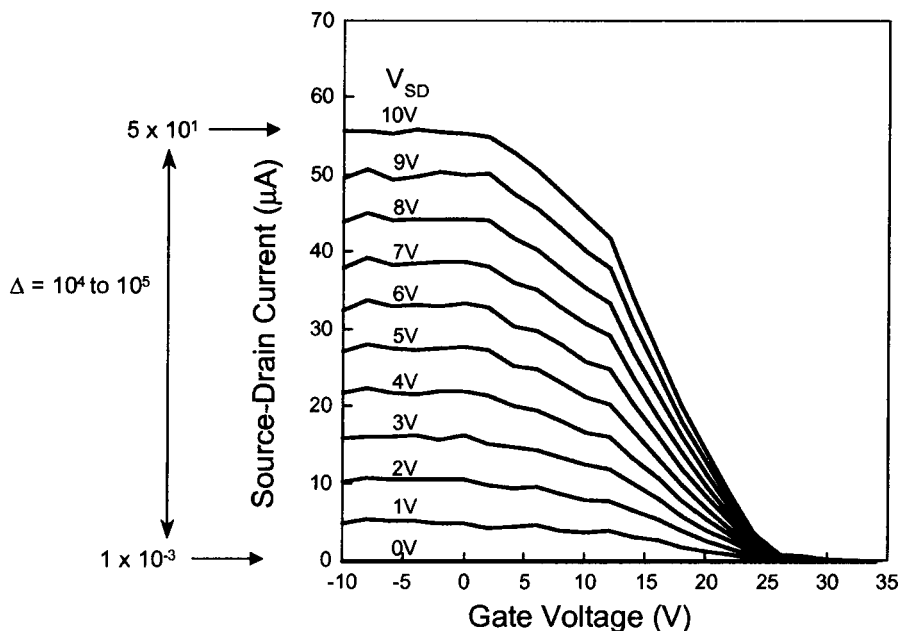

Figure 15. Field Effect Transistor characteristics.

The doped “metallic” PEDOT film ( $\sigma \sim 2 \text{ S/cm}$  at room temperature) would not be expected to show a change in conductivity by exposure to a field of this type under the configuration used. We believe this effect presents an entirely new method for ascertaining the nature of highly doped “metallic” conducting polymers. It has frequently been postulated that a doped conducting polymer consists of metallic “islands” surrounded by lowly conducting “beaches” as shown in Figure 16. We postulate that in the effect we have observed only the lowly conducting “beaches” and not the metallic “islands” respond to the applied field. The application of an electric field changes the conductivity of the “beaches” and hence the extent of electrical percolation in the source/drain PEDOT electrode between the metallic “islands”, hence changing the bulk conductivity of the material. The response time for our device is much slower than for a conventional field effect transistor. We therefore conjecture that the chief changes in conductivity are probably caused by

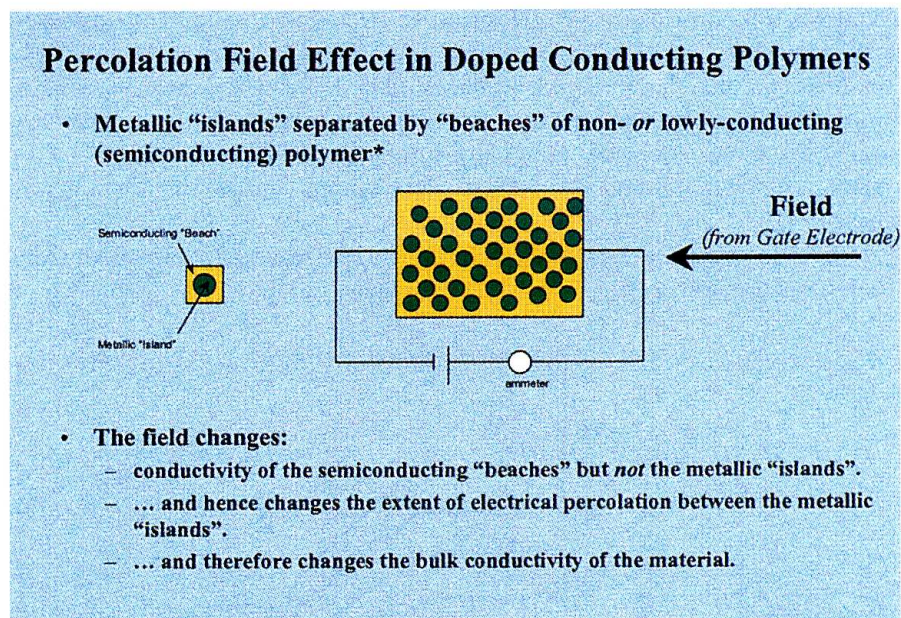

Figure 16. Percolation field effect in doped conducting polymers.

slow diffusion of the dopant anions under influence of the applied field. On removal of the field the system reverts to its original state.

Preliminary studies show that the effect is also present in polyaniline; it may therefore possibly be found in many other conducting polymers and would thus represent a general phenomenon characteristic of all conducting polymers, at least within certain ranges of doping.

#### SUMMARY

- Polyacetylene,  $(\text{CH})_x$ , the simplest organic polymer, can be reversibly doped to the metallic regime by partial oxidation or reduction either chemically or electrochemically.
- Polyaniline can be doped to the metallic regime by a simple acid/base protonation.
- A large number of electronic conductive polymers are now known.
- A variety of technological applications of electronic conductive polymers, present and projected, are apparent.

#### ACKNOWLEDGMENT

This Nobel Prize has world-wide implications since it shows the ever-increasing importance of interdisciplinary research – in this case collaborative research between a polymer chemist, Hideki Shirakawa, Alan Heeger, a physicist, and myself, an organometallic chemist. Each of us had the task of learning the specialized scientific language of the other in order to collec-

tively focus on one specific scientific challenge, an example of where  $1+1 + 1$  is more than 3!

The prize is also recognition of the good fortune that Alan, Hideki and I had in having each other as such excellent colleagues and also in having such creative colleagues in each of our respective individual research groups – the work stemming from a research group cannot be better than the persons carrying it out. The Prize is a recognition of them and their work and also the work of countless others world-wide during the past 23 years who put the “flesh on the skeleton work” carried out by us in the 1970’s at Penn. If it were not for them there would be no prize today in the field.

Research in an experimental science (and also in many other fields) cannot be accomplished without financial support for stipends, apparatus, supplies and the like. A funding organization and project officers within such an organization have tremendous control over the future of science and technology in any given country. In this respect Dr. Kenneth J. Wynne, my contracting officer at the U.S. Office of Naval Research for many years, before his recent retirement, had the scientific intuition and foresight to fund our first work on conducting polymers – the first funding of work of this type anywhere in the world. He funded it because of its scientific interest. The fact that it now has great technological potential was not a consideration at that time.

”Of what use is a beautiful poem”? It gives intellectual stimulation and enjoyment. Similarly with research. If it has some practical use, that is merely “icing on the cake!”

## EARLY STUDIES

*Polyacetylene*,  $(CH)_x$ : Alan J. Heeger (*formerly*, Physics Dept, Univ. of Penn) Hideki Shirakawa (Tsukuba University) and many undergraduate, graduate students and post doctoral fellows. *Financial Support*: Principally, US Office of Naval Research;\* University of Pennsylvania Materials Science Laboratory.

*Polyaniline*: Arthur J. Epstein (Physics Dept, Ohio State University) and many undergraduate, graduate students and post doctoral fellows. *Financial Support*: Principally, US Office of Naval Research;\* University of Pennsylvania Materials Science Laboratory.

## RECENT STUDIES

*Nanofibers (“Electrospinning”)*: I.D. Norris, J. Gao, F.K. Ko, W.E. Jones, Jr., A.T. Johnson, Jr. *Financial Support*: US Office of Naval Research;\* Army Research Office – MURI.

*Line Patterning*: D. Hohnholz, H. Okuzaki. *Financial Support*: Subcontract, Kent Displays, Inc. (ONR-SBIR Program); US Office of Naval Research;\* Fellowship from Ministry of Education, Science, Culture and Sports, Japan.

\* Dr. K.J. Wynne, Program Manager, US Office of Naval Research

## REFERENCES

1. H.S. Nalwa, (ed.), *Handbook of Organic Conductive Materials and Polymers*, Wiley, New York (1997); T.A. Skotheim, R.L. Elsenbaumer, J.F. Reynolds (eds.), *Handbook of Conducting Polymers*, 2nd Ed., Marcel Dekker, New York (1998).
2. J.H. Schon, A. Dodabalapur, Z. Bao, C. Kloc, O. Schenker, B. Batlogg, *Nature*, **410**, 189 (2001).
3. A.G. MacDiarmid and A.J. Epstein, *Faraday Discuss. Chem. Soc.*, **88**, 317 (1989) and references therein.
4. A.G. MacDiarmid and A.J. Heeger, *Synth. Met.*, **1**, 101 (1979/80) and references therein.
5. T.A. Skotheim, (ed.), *Handbook of Conducting Polymers, 1 & 2*, Marcel Dekker, New York (1986).
6. M.G. Kanatzidis, *Chemical & Engineering News*, 3 December, 36 (1990).
7. C.K. Chiang, C.R. Fincher, Jr., Y.W. Park, A.J. Heeger, H. Shirakawa, E.J. Louis, A.G. MacDiarmid, *Phys. Rev. Lett.*, **39**, 1098 (1977); C.K. Chiang, M.A. Druy, S.C. Gau, A.J. Heeger, E.J. Louis, A.G. MacDiarmid, *J. Am. Chem. Soc.*, **100**, 1013 (1978).
8. K.E. Ziemelis, A.T. Hussain, D.D.C. Bradley, R.H. Friend, J. Rilhe and G. Wegner, *Phys. Rev. Lett.*, **66**, 2231 (1991).
9. V.G. Kulkarni, W.R. Mathew, J.C. Campbell, C.J. Dinkins, and P.J. Durbin, in *49th ANTEC Conference Proceedings*, Society of Plastic Engineers and Plastic Engineering, Montreal, Canada, 5-9 May, p. 663 (1991); L.W. Shacklette, N.F. Colaneri, V.G. Kulkarni and B. Wessling, in *49th ANTEC Conference Proceedings*, Society of Plastic Engineers and Plastic Engineering, Montreal, Canada, 5-9 May, p. 665 (1991).
10. P.J. Nigrey, A.G. MacDiarmid and A.J. Heeger, *J. Chem. Soc. Chem. Commun.*, 594 (1979).
11. D. MacInnes, Jr, M.A. Druy, P.J. Nigrey, D.P. Nairns, A.G. MacDiarmid and A.J. Heeger, *J. Chem. Soc. Chem. Commun.*, 317 (1981).
12. A.J. Heeger, S. Kivelson, J.R. Schrieffer and W.-P. Su, *Rev. Mod. Phys.*, **60**, 781 (1988) and references therein.
13. J.H. Burroughes, C.A. Jones, and R.H. Friend, *Nature*, **335**, 137 (1988); J.H. Burroughes, D.D.C. Bradley, A.R. Brown, R.N. Marks, R.H. Friend, *et al.*, *Nature*, **347**, 539 (1990).
14. J.C. Chiang and A.G. MacDiarmid, *Synth. Met.*, **13**, 193 (1986).
15. A.G. MacDiarmid, J.-C. Chiang, A.F. Richter and A.J. Epstein, *Synth. Met.*, **18**, 285 (1987).
16. A.G. MacDiarmid and A.J. Epstein, *Faraday Discuss. Chem. Soc.*, **88**, 317 (1989) and references therein; A.G. MacDiarmid and A.J. Epstein, in *Science and applications of conducting polymers*, ed. W. R. Salaneck, D. T. Clark, and E. J. Samuelsen, Adam Hilger, Bristol, UK, p. 117 (1990).
17. C.C. Han and R.L. Elsenbaumer, *Synth. Met.*, **30**, 123 (1989).
18. A.G. MacDiarmid, J.-C. Chiang, A.F. Richter, N.L.D. Somasiri and A.J. Epstein, in *Conducting Polymers*, ed. L. Alcacer, Reidel Publications, Dordrecht, p. 105 (1987).
19. F.L. Lu, F. Wudl, M. Nowak and A.J. Heeger, *J. Am. Chem. Soc.*, **108**, 8311 (1986).
20. Y. Sun, A.G. MacDiarmid and A.J. Epstein, *J. Chem. Soc. Chem. Commun.*, 529 (1990).
21. "Nanotechnology- A Revolution in the Making – Vision for R&D in the Next Decade," report of the Interagency Working Group on Nanoscience, Engineering, and Technology, March 10, 1999.
22. A. Formhals, US Patent No. 1,975,504 (1934).
23. I.D. Norris, M.M. Shaker, F.K. Ko and A.G. MacDiarmid, *Synth. Met.*, **114**(2), 109 (2000); A.G. MacDiarmid, W.E. Jones, Jr., I.D. Norris, J. Gao, A.T. Johnson, Jr., N.J. Pinto, J. Hone, B. Han, F.K. Ko, H. Okuzaki and M. Llagune, *Synth. Met.*, **119**, 27 (2001).
24. J. Doshi and D.H. Reneker, *J. Electrostat.* **35**, 151 (1995); P.W. Gibson, H.L. Schreuder-Gibson and D. Riven, *AIChE J.* **45**, 190 (1999).

25. D.H. Reneker, A. L. Yarin, H.Fong and S. Koombhongse, *J. Appl. Phys.* **87**, 4531 (2000).
26. S. Iijima, *Nature*, **354**, 56 (1991).
27. D.H. Reneker and I. Chun, *Nanotechnology*, **7(3)**, 216 (1996).
28. Z. Huang, P-C. Wang, A.G. MacDiarmid, Y. Xia, and G. M. Whitesides, *Langmuir*, **13** (1997) 6480; R.V. Gregory, W.C. Kimbrell and H.H. Kuhn, *Synth. Met.*, **28(1-2)**, C823 (1989).
29. A.M. Sullivan and P.A. Kohl, *J. Electrochem. Soc.*, **142(7)**, 2250 (1995).
30. I. Chun, D.H. Reneker, H. Fong, X. Fang, J. Deitzel, N.B. Tan and K. Kearns, *J. Advanced Materials*, **31**, 36 (1999); D. Hohnholz and A.G. MacDiarmid, *Synth. Met.*, **121**, 1327 (2001).
31. A. Dodabalapur, Z. Bao, A. Makhija, J. G. Laquindanum, V. R. Raju, Y. Feng, H. E. Katz and J. Rogers, *App. Phys. Lett.*, **73**, 142 (1998) and refs. therein.
32. C.J. Drury, C.M.J. Mutsaers, C.M. Hart, M. Matters and D. M. de Leeuw, *App. Phys. Lett.*, **73**, 108 (1998) and refs. therein.
33. H. Okusaki and Y. Osada, *J. Intell. Mater. Syst. Struct.*, **4**, 50 (1993).
34. "Licrystal E7" (Merck Corp., Germany), "NOA-65 Optical Adhesive" (Norland Products, NH USA).