

# EVOLUTION OF IDEAS ON THE PRIMARY VISUAL CORTEX, 1955-1978: A BIASED HISTORICAL ACCOUNT

Nobel lecture, 8 December 1981

by

DAVID H. HUBEL

Harvard Medical School, Department of Neurobiology,  
Boston, Massachusetts, U.S.A.

## INTRODUCTION

In the early spring of 1958 I drove over to Baltimore from Washington, D.C., and in a cafeteria at Johns Hopkins Hospital met Stephen Kuffler and Torsten Wiesel, for a discussion that was more momentous for Torsten's and my future than either of us could have possibly imagined.

I had been at Walter Reed Army Institute of Research for three years, in the Neuropsychiatry Section headed by David Rioch, working under the supervision of M.G.F. Fuortes. I began at Walter Reed by developing a tungsten microelectrode and a technique for using it to record from chronically implanted cats, and I had been comparing the firing of cells in the visual pathways of sleeping and waking animals.

It was time for a change in my research tactics. In sleeping cats only diffuse light could reach the retina through the closed eyelids. Whether the cat was asleep or awake with eyes open, diffuse light failed to stimulate the cells in the striate cortex. In waking animals I had succeeded in activating many cells with moving spots on a screen, and had found that some cells were very selective in that they responded when a spot moved in one direction across the screen (e.g. from left to right) but not when it moved in the opposite direction (1) (Fig. 1). There were many cells that I could not influence at all. Obviously there was a gold mine in the visual cortex, but methods were needed that would permit the recording of single cells for many hours, and with the eyes immobilized, if the mine were ever to begin producing.

I had planned to do a postdoctoral fellowship at Johns Hopkins Medical School with Vernon Mountcastle, but the timing was awkward for him because he was remodeling his laboratories. One day Kuffler called and asked if I would like to work in his laboratory at the Wilmer Institute of Ophthalmology at the Johns Hopkins Hospital with Torsten Wiesel, until the remodeling was completed. That was expected to take about a year. I didn't have to be persuaded; some rigorous training in vision was just what I needed, and though Kuffler himself was no longer working in vision the tradition had been maintained in his laboratory. Torsten and I had visited each other's laboratories and it was clear that we had common interests and similar outlooks. Kuffler

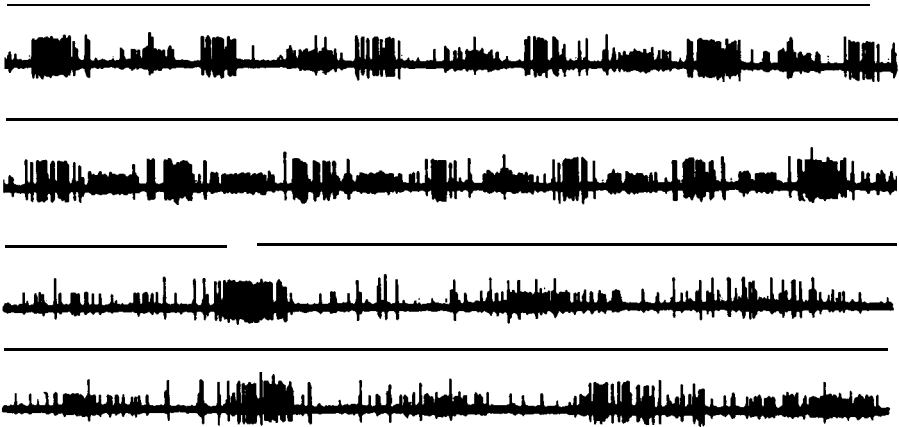

Figure 1. Continuous recording from striate cortex of an unrestrained cat. In each dual trace the lower member shows the microelectrode oscilloscope recording from two cells, one with large impulses, the other smaller ones. The stimulus was small to-and-fro hand movements in front of the cat. Each movement interrupted a light beam falling on a photoelectric cell, producing the notches in the upper beam. The upper two pairs of records represent fast movements, the lower ones slower movements. Each line represents 4 seconds. (1)

suggested that I come over to discuss plans, and that was what led to the meeting in the cafeteria.

It was not hard to decide what to do. Kuffler had described two types of retinal ganglion cells, which he called “on-center” and “off-center”. The receptive field of each type was made up of two mutually antagonistic regions, a center and a surround, one excitatory and the other inhibitory. In 1957 Barlow, FitzHugh and Kuffler had gone on to show that as a consequence retinal ganglion cells are less sensitive to diffuse light than to a spot just filling the receptive-field center (2). It took me some time to realize what this meant: that the way a cell responds to any visual scene will change very little when, for example, the sun goes behind a cloud and the light reflected from black and white objects decreases by a large factor. The cell virtually ignores this change, and our subjective assessment of the objects as black or white is likewise practically unaffected. Kuffler’s center-surround receptive fields thus began to explain why the appearance of objects depends so little on the intensity of the light source. Some years later Edwin Land showed that the appearance of a scene is similarly relatively independent of the exact color composition of the light source. The physiological basis of this color independence has yet to be worked out.

The strategy (to return to our cafeteria) seemed obvious. Torsten and I would simply extend Stephen Kuffler’s work to the brain; we would record from geniculate cells and cortical cells, map receptive fields with small spots, and look for any further processing of the visual information.

My reception in Kuffler’s office the first day was memorable. I was nervous and out of breath. Steve at his desk, rotated around on his chair and said “Hi, David! Take off your coat. Hang up your hat. Do up your fly.” His laboratory

was informal! But it took me a month, given my Canadian upbringing, to force myself to call him Steve. For the first three months no paycheck arrived and finally I screwed up the courage to go in and tell him. He laughed and laughed, and then said "I forgot!"

Torsten and I didn't waste much time. Within a week of my coming to Hopkins (to a dark and dingy inner windowless room of the Wilmer Institute basement, deemed ideal for visual studies) we did our first experiment. For the time being we finessed the geniculate (at Walter Reed I had convinced myself that geniculate cells were center-surround) and began right away with cortex. The going was rough. We had only the equipment for retinal stimulation and recording that had been designed a few years before by Talbot and Kuffler (3). A piece of apparatus resembling a small cyclotron held the anesthetized and paralyzed cat with its head facing almost directly upwards. A modified ophthalmoscope projected a background light and a spot stimulus onto the retina. The experimenter could look in, see the retina with its optic disc, area centralis and blood vessels, and observe the background light and the stimulus spots. Small spots of light were produced by sliding 2 cm x 5 cm metal rectangles containing various sizes of holes into a slot in the apparatus, just as one puts a slide into a slide projector. To obtain a black spot on a light background one used a piece of glass like a microscope slide, onto which a black dot had been glued. All this was ideal for stimulating the retina and recording directly from retinal ganglion cells, since one could see the electrode tip and know where to stimulate, but for cortical recording it was horrible. Finding a receptive field on the retina was difficult, and we could never remember what part of the retina we had stimulated. After a month or so we decided to have the cat face a projection screen, as I had at Walter Reed and as Talbot and Marshall had in 1941 (4). Having no other head holder, we continued for a while to use the ophthalmoscope's head holder, which posed a problem since the cat was facing directly up. To solve this we brought in some bed sheets which we slung between the pipes and cobwebs that graced the ceiling of the Wilmer basement, giving the setup the aura of a circus tent. On the sheets we projected our spots and slits. One day Vernon Mountcastle walked in on this scene, and was horror struck at the spectacle. The method was certainly inconvenient since we had to stare at the ceiling for the entire experiment. Then I remembered having seen in Mountcastle's laboratory a Horsley-Clarke head holder that was not only no longer being used but also had the name of the Wilmer Institute engraved on it. It was no other than the instrument that Talbot had designed for visual work when he and Marshall mapped out visual areas I and II in the cat, in 1941 (4). For years Vernon had used it in his somatosensory work, but he had recently obtained a fancier one. Torsten and I decided to reclaim the Wilmer instrument, not without some trepidation. To give ourselves confidence we both put on lab coats, for the first and last times in our lives, and looking very professional walked over to Physiology. Though Mountcastle was his usual friendly and generous self, I suspect he was loath to part with this treasure, but the inscription on the stainless steel was not to be denied and we walked off with it triumphantly. It is still in use (now at Harvard: we literally stole it from the

Wilmer), and has probably the longest history of uninterrupted service of any Horsley-Clarke in the world.

A short while before this adventure we had gone to a lecture by Vernon (this was a few years after his discovery of cortical columns) (5) in which he had amazed us by reporting on the results of recording from some 900 somatosensory cortical cells, for those days an astronomic number. We knew we could never catch up, so we catapulted ourselves to respectability by calling our first cell No. 3000 and numbering subsequent ones from there. When Vernon visited our circus tent we were in the middle of a S-unit recording, cell Nos. 3007, 3008, and 3009. We made sure that we mentioned their identification numbers. All three cells had the same receptive-field orientation but neither Vernon nor we realized, then, what that implied.

At times we were peculiarly inept. Our first perfusion of a cat was typical. One morning at about 2:00 a.m. we had arranged two huge bottles on an overhead shelf, for saline and formalin, and were switching over from saline to formalin when the rubber tubing came off the outlet of the formalin bottle and gave us an acrid early morning cold shower. We did not relish being preserved at so young an age! The reference to 2:00 a.m. perhaps deserves some comment, because neurophysiologists, at least those who study animals, have the reputation of doing experiments that last for days without respite. We soon found that such schedules were not for us. I knew we were losing traction in an experiment when Torsten began to talk to me in Swedish; usually this was around 3:00 a.m. The longest experiment we ever did was one in which I arrived home just as my family was sitting down for breakfast. I had almost driven off the road on the way back. At the risk of becoming what Mountcastle termed "part-time scientists" we decided to be more lenient with ourselves, giving the deteriorating condition of the animal as the official reason for stopping early.

Our first real discovery came about as a surprise. We had been doing experiments for about a month. We were still using the Talbot-Kuffler ophthalmoscope and were not getting very far: the cells simply would not respond to our spots and annuli. One day we made an especially stable recording. (We had adapted my chronic recording system, which made use of Davies' idea of a closed chamber (6). to the acute experimental animals, and no vibrations short of an earthquake were likely to dislodge things.) The cell in question lasted 9 hours, and by the end we had a very different feeling about what the cortex might be doing. For 3 or 4 hours we got absolutely nowhere. Then gradually we began to elicit some vague and inconsistent responses by stimulating somewhere in the midperiphery of the retina. We were inserting the glass slide with its black spot into the slot of the ophthalmoscope when suddenly over the audiometer the cell went off like a machine gun. After some fussing and fiddling we found out what was happening. The response had nothing to do with the black dot. As the glass slide was inserted its edge was casting onto the retina a faint but sharp shadow, a straight dark line on a light background. That was what the cell wanted, and it wanted it, moreover, in just one narrow range of orientations.

This was unheard of. It is hard, now, to think back and realize just how free we were from any idea of what cortical cells might be doing in an animal's daily life. That the retinas mapped onto the visual cortex in a systematic way was of course well known, but it was far from clear what this apparently unimaginative remapping was good for. It seemed inconceivable that the information would enter the cortex and leave it unmodified, especially when Kuffler's work in the retina had made it so clear that interesting transformations took place there between input and output. One heard the word "analysis" used to describe what the cortex might be doing, but what one was to understand by that vague term was never spelled out. In the somatosensory cortex, the only other cortical area being closely scrutinized, Mountcastle had found that the cells had properties not dramatically different from those of neurons at earlier stages.

Many of the ideas about cortical function then in circulation seem in retrospect almost outrageous. One has only to remember the talk of "suppressor strips", reverberating circuits, or electrical field effects. This last notion was taken so seriously that no less a figure than our laureate-colleague Roger Sperry had had to put it to rest, in 1955, by dicing up the cortex with mica plates to insulate the subdivisions, and by skewering it with tantalum wire to short out the fields, neither of which procedures seriously impaired cortical function (7, 8). Nevertheless the idea of ephaptic interactions was slow to die out. There were even doubts as to the existence of topographic representation, which was viewed by some as a kind of artifact. One study, in which a spot of light projected anywhere in the retina evoked potentials all over the visual cortex, was interpreted as a refutation of topographic representation, but the result almost certainly came from working with a dark-adapted cat and a spot so bright that it scattered light all over the retina. It is surprising, in retrospect, that ideas of non-localization could survive in the face of the masterly mapping of visual fields onto the cortex in rabbit, cat and monkey done by Talbot and Marshall far back in 1941 (4).

It took us months to convince ourselves that we weren't at the mercy of some optical artifact, such as anyone can produce by squinting one's eyes and making vertical rays emanate from street lights. We didn't want to make fools of ourselves quite so early in our careers. But recording in sequence in the same penetration several cells with several different optimal orientations would, I think, have convinced anyone. By January we were ready to take the cells we thought we could understand (we later called them "simple cells") and write them up. Then as always what guided and sustained us was the attitude of Stephen Kuffler, who never lectured or preached but simply reacted with buoyant enthusiasm whenever he thought we had found something interesting, and acted vague and noncommittal when he found something dull. Neither of us will ever forget writing our first abstract, for the International Congress of Physiology in 1959 (9). We labored over it, and finally gave a draft to Kuffler. The following day when I came in Torsten was looking more glum than usual, and said "I don't think Steve much liked our abstract". It was clear enough that Kuffler wasn't quite satisfied: his comments and suggestions contained

Single units were recorded extracellularly from ~~the~~ striate cortex of ~~the~~  
 lightly anesthetized cat. <sup>S</sup>With the eye immobilized restricted light stimuli of  
 various shapes were shone on the light adapted retina. <sup>Re the fields of various</sup> Most receptive fields  
~~cells were analyzed and found to have a receptive field which~~  
 could be subdivided into excitatory and inhibitory regions, as found for  
 in many respects was similar to that of ~~the~~ <sup>These</sup> ~~retinal~~ <sup>retinal</sup> ganglion cells (Kuffler, 1953). These regions mutually interacted,  
 so that a large spot covering the entire field was usually ineffective. However  
~~at times these responses were not as simple as the above and~~  
 excitatory and inhibitory areas were arranged in several types of specialized  
 balanced and other effects. ~~of which the most common was a large~~  
 and complex patterns, and specific stimuli were required for effective driving. ~~Some~~  
~~units were being ineffective in pattern.~~  
 concentric receptive fields described for retinal ganglion cells were not seen  
 in the cortex. For example, frequently an excitatory and inhibitory region was  
 long and narrow with areas of opposite type on either side only. <sup>the two flanking</sup>  
 regions were oriented in a vertical, horizontal or oblique manner. <sup>the two flanking</sup>  
 regions were often but not always equally distributed, ~~as in the case of the~~  
~~controversies.~~ <sup>They give the strongest response of a slit oriented</sup>  
 with this type of field a stationary slit of light when flashed  
 onto the retina with appropriate position and orientation gave (the strongest)  
 responses. <sup>the slit</sup> Responses to transverse movements of slits were also dependent on  
 the slit orientation. Many units could be binocularly activated, and when  
 mapped out in the two eyes separately the receptive fields were found to have  
 a similar organization.

Figure 2. First draft our first abstract (8), showing comments by Kuffler.

more words than our original (Fig. 2) ! Writing, it may be added, did not come easy to either of us at the beginning, and our first paper, in 1959 (10) went through eleven complete reworkings.

### HIERARCHY OF VISUAL CELLS

During the years 1959-62, first at the Wilmer Institute and then at Harvard Medical School, we were mainly concerned with comparing responses of cells in the lateral geniculate body and primary visual cortex of the cat. In the lateral geniculate we quickly confirmed my Walter Reed finding that the receptive

fields are like those of retinal ganglion cells in having an antagonistic concentric center-surround organization. But now we could compare directly the responses of a geniculate cell with those of a fiber from an afferent retinal ganglion cell, and we found that in geniculate cells the power of the receptive-field surround to cancel the input from the center was increased. This finding was subsequently confirmed and extended in a beautiful set of experiments by Cleland, Dubin and Levick (11), and for many years remained the only known function of the lateral geniculate body.

In the cat striate cortex it soon became evident that cells were more complex than geniculate cells, and came in several degrees of complexity (12). One set of cells could be described by techniques similar to those used in the retina by Kuffler; we called these "simple". Their receptive fields, like the fields of retinal ganglion cells and of lateral geniculate cells, were subdivided into antagonistic regions illumination of any one of which tended to increase or decrease the rate of firing. But simple cells differed from retinal ganglion cells and lateral geniculate cells in the striking departure of their receptive fields from circular symmetry; instead of a single circular boundary between center and surround the antagonistic subdivisions were separated by parallel straight lines whose orientation (vertical, horizontal or oblique) soon emerged as a fundamental property (Fig. 3a). The optimal stimulus, either a slit, dark bar or edge, was easily predictable from the geometry of the receptive field, so that a stationary line stimulus worked optimally when its boundaries coincided with the boundaries of the subdivisions (Fig. 3c), and displacing the line to a new position parallel to the old one generally resulted in a sharp decline in the response. Perhaps most remarkable of all was the precise nature of the spatial distribution of excitatory and inhibitory effects: not only did diffuse light produce no response (as though the excitatory and inhibitory effects were mutually cancelling with the precision of an acid-base titration), but any line oriented at  $90^\circ$  to the optimal was also without effect, regardless of its position along the field, suggesting that the subpopulations of receptors so stimulated also had precisely mutually cancelling effects.

In the cat, simple cells are mostly found in layer IV, which is the site of termination of the bulk of the afferents from the lateral geniculate body. The exact connections that lead to orientation specificity are still not known, but it is easy to think of plausible circuits. For example, the behavior of one of the commonest kinds of simple cells may be explained by supposing that the cell receives convergent excitatory input from a set of geniculate cells whose on-centers are distributed in overlapping fashion over a straight line (Fig. 3b). In the monkey, the cells of Layer IVc (where most geniculate fibers terminate) seem all to be concentric center-surround, and the simple cells are probably mainly in the layers immediately superficial to IVc. No one knows why this extra stage of center-surround cells is intercalated in the monkey's visual pathway.

The next set of cells we called "complex" because their properties cannot be derived in a single logical step from those of lateral geniculate cells (or, in the monkey, from the concentric cells of layer IVc). For the complex cell, com-

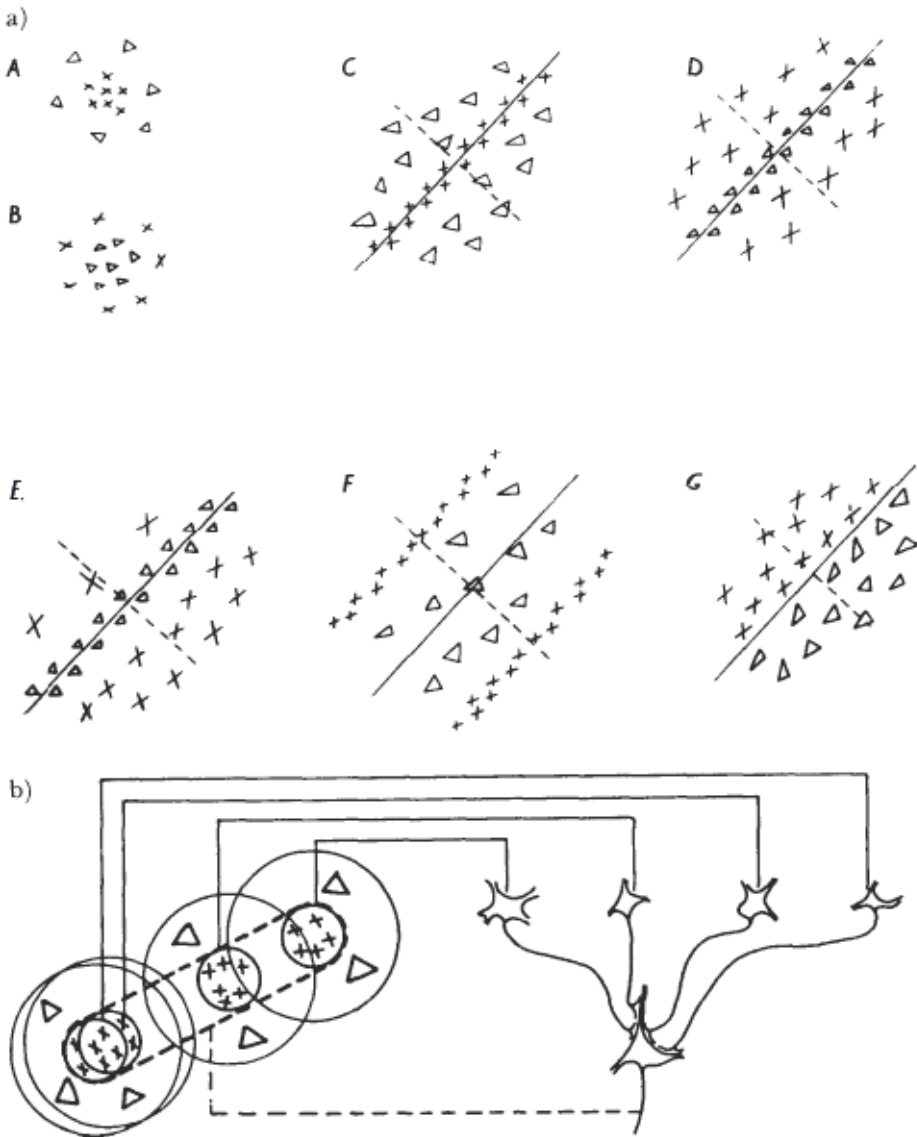

Figure 3. a) Common arrangement of lateral geniculate (A and B) and simple cortical (C–G) receptive fields. X, areas giving excitatory responses ('on' responses);  $\Delta$ , areas giving inhibitory responses ('off' responses). Receptive-field orientations are shown by continuous lines through field centers; in the figure these are all oblique, but each arrangement occurs in all orientations (Fig. 2 (12)).

b) Possible scheme for explaining the organization of simple receptive fields. A large number of lateral geniculate cells, of which four are illustrated in the right in the figure, have receptive fields with 'on' centers arranged along a straight line on the retina. All of these project upon a single cortical cell, and the synapses are supposed to be excitatory. The receptive field of the cortical cell will then have an elongated 'on' center indicated by the interrupted lines in the receptive-field diagram to the left of the figure (Fig. 19 (12)).

c) Responses to shining a rectangular slit of light  $1 \times 8^\circ$ , so that center of slit is superimposed on center of receptive field, in various orientations, as shown. Receptive field is of type C (see part (a) of this Figure), with axis vertically oriented (Fig. 3 (10)).



c)

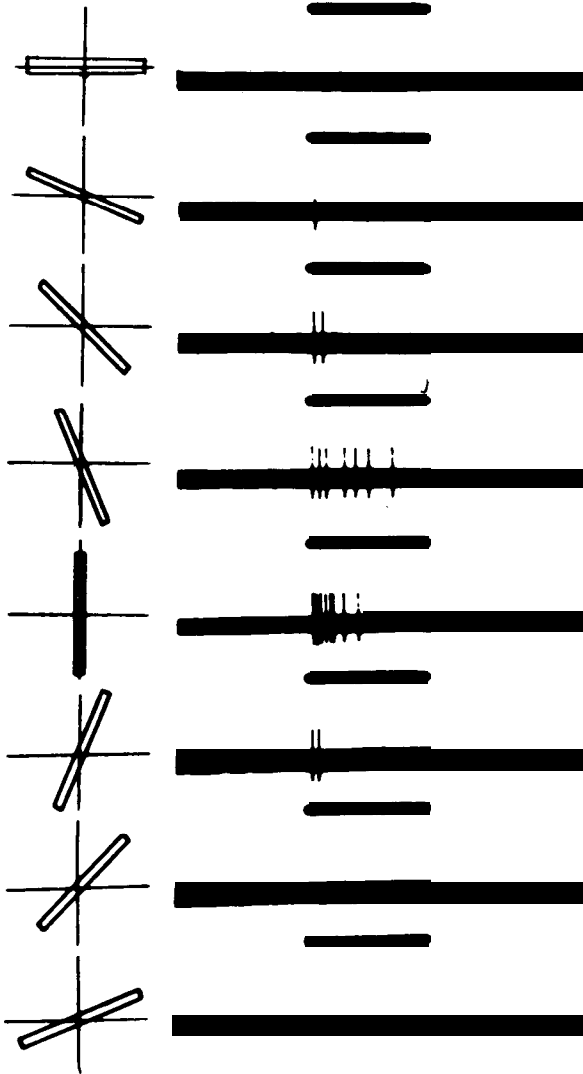

pared to the simple cell, the position of an optimally oriented line need not be so carefully specified: the line works anywhere in the receptive field, evoking about the same response wherever it is placed (Fig. 4a). This can most easily be explained by supposing that the complex cell receives inputs from many simple cells, all of whose receptive fields have the same orientation but differ slightly in position (Fig. 4b). Sharpness of tuning for orientation varies from cell to cell, but the optimal orientation of a typical complex cell in layer II or III in the monkey can be easily determined to the nearest 5-10°, with no more equipment than a slide projector.

For a complex cell, a properly oriented line produces especially powerful responses when it is swept across the receptive field (Fig. 4c). The discharge is generally well sustained as long as the line keeps moving, but falls off quickly if the stimulus is stationary. About half of the complex cells fire much better to one direction of movement than to the opposite direction, a quality called

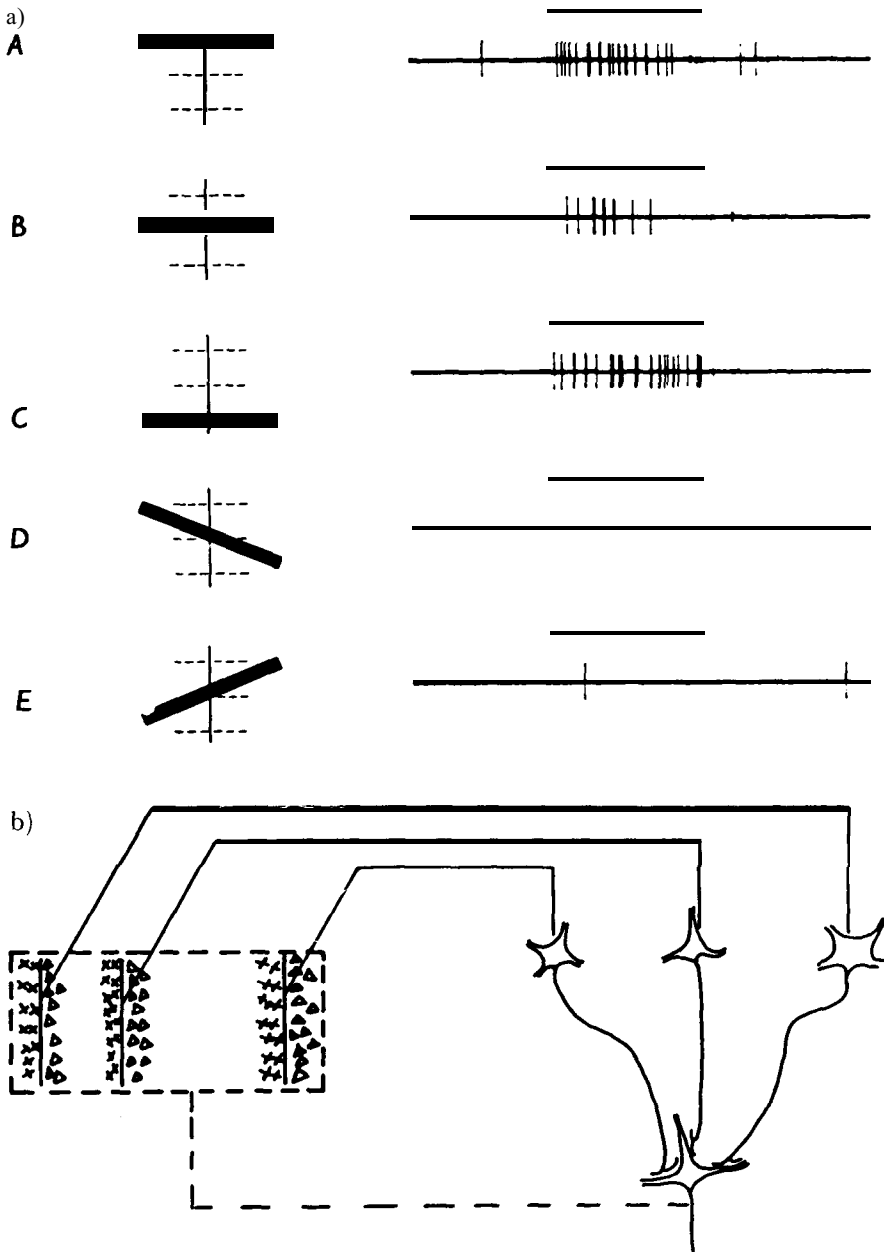
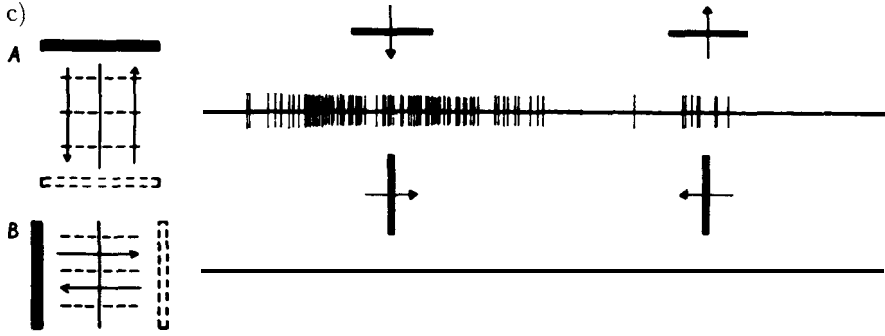

Figure 4. a) Complex cell responding best to a black horizontally oriented rectangle placed anywhere in the receptive field (A-C). Tilting the stimulus rendered it ineffective (D, E).

b) Same cell, showing response to a moving horizontal bar, downward movement better than upward (A), and no response to a moving vertical bar (B) Time 1 sec. (Figs. 7 and 8 (12)).

c) Possible scheme for explaining the organization of complex receptive fields. A number of cells with simple fields, of which three are shown schematically, are imagined to project to a single cortical cell of higher order. Each projecting neuron has a receptive field arranged as shown to the left: an excitatory region to the left and an inhibitory region to the right of a vertical straight-line boundary. The boundaries of the fields are staggered within an area outlined by the interrupted lines. Any vertical-edge stimulus falling across this rectangle, regardless of its position, will excite some simple-field cells, leading to excitation of the higher-order cell. (Fig. 20 (12)).



"directional selectivity", which probably cannot be explained by any simple projection of simple cells onto complex cells, but seems to require inhibitory connections with time delays of the sort proposed by Barlow and Levick for rabbit retinal ganglion cells (13).

### HYPERCOMPLEX CELLS

Many cells, perhaps 10-20% in area 17' of cat or monkey, respond best to a line (a slit, edge or dark bar) of limited length; when the line is prolonged in one direction or both, the response falls off. This is called "end stopping". In some cells the response to a very long line fails completely (Fig. 5) (14). We originally called these cells "hypercomplex" because we looked upon them as next in an ordered hierarchical series, after simple and complex. We saw hypercomplex cells first in areas 18 and 19 of the cat, and only later in area 17. Dreher subsequently found cells, in all other ways resembling simple cells, that showed a similar fall-off in response as the length of the stimulus exceeded some optimum (15). It seems awkward to call these cells hypercomplex; they are probably better termed "simple end-stopped" in contrast to "complex end-stopped".

Complex cells come in a wide variety of subtypes. Typical cells of layer II and III have relatively small receptive fields, low spontaneous activity, and in the monkey may not only be highly orientation selective but also fussy about wave length, perhaps responding to red lines but not white. They may or may not be end-stopped. Cells in layers V and VI have larger fields. Those in V have high spontaneous activity and many respond just as well to a very short moving line as to long one. Many cells in layer VI respond best to very long lines (16). These differences are doubtless related to the important fact, first shown with physiologic techniques by Toyama, Matsunami and Ohno (17) and confirmed and extended by anatomical techniques, that different layers project to different destinations - the upper layers mainly to other cortical regions, the fifth layer to the superior colliculus, pons and pulvinar, and VI back to the lateral geniculate body and to the claustrum.

In the last 10 or 15 years the subject of cortical receptive-held types has become rather a jungle, partly because the terms 'simple' and 'complex' are used differently by different people, and undoubtedly partly because the categories themselves are not cleanly separated. Our idea originally was to empha-

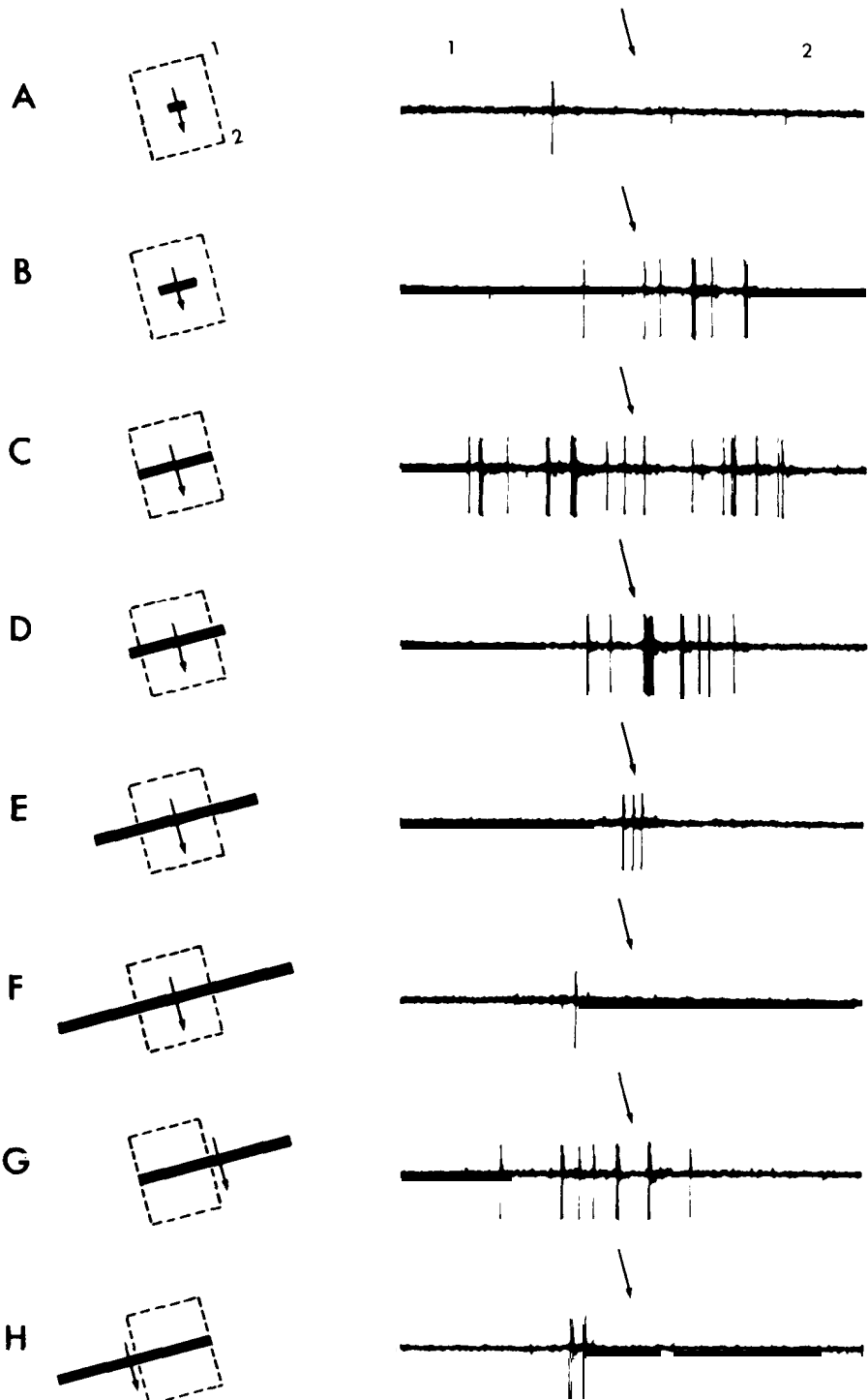

Figure 5. Hypercomplex cell, responding to a black bar oriented 2:30-8:30, moving downward. Optimum response occurred when stimulus swept over area outlined (C); stimulating more than this region (D-H) or less (A, B) resulted in a weaker response. Sweep duration 2.5 sec. (Fig. 19 (14)).

size the tendency toward increased complexity as one moves centrally along the visual path, and the possibility of accounting for a cell's behavior in terms of its inputs. The circuit diagrams we proposed were just a few examples from a number of plausible possibilities. Even today the actual circuit by which orientation specificity is derived from center-surround cells is not known, and indeed the techniques necessary for solving this may still not be available. One can nevertheless say that cells of different complexities, whose receptive fields are in the same part of the visual field and which have the same optimal orientation, are likely to be interconnected, whereas cells with different optimal orientations are far less likely to be interconnected. In the monkey a major difficulty with the hierarchical scheme as outlined here is the relative scarcity of simple cells, compared with the huge numbers of cells with concentric fields in IVc, or compared with the large number of complex cells above and below layer IV. The fact that the simple cells have been found mainly in layer IVb also agrees badly with Jennifer Lund's finding that layer IVc $\beta$  projects not to layer IVb but to layer III. One has to consider the possibility that in the monkey the simple-cell step may be skipped, perhaps by summing the inputs from cells in layer IV on dendrites of complex cells. In such a scheme each main dendritic branch of a complex cell would perform the function of a simple cell. All such speculation serves only to emphasize our ignorance of the exact way in which the properties of complex cells are built up.

Knowing how cortical cells respond to some visual stimuli and ignore others allows us to predict how a cell will react to any given visual scene. Most cortical cells respond poorly to diffuse light, so that when I gaze at a white object on a dark background, say an egg, I know that those cells in my area 17 whose receptive fields fall entirely within the boundaries of the object will be unaffected. Only the fields that are cut by the borders of the egg will be influenced, and then only if the local orientation of a border is about the same as the orientation of the receptive field. A slight change in position of the egg without changing its orientation will produce a dramatic change in the population of activated simple cells, but a much smaller change in the activated complex cells.

Orientation-specific simple or complex cells "detect" or are specific for the direction of a short line segment. The cells are thus best not thought of as "line detectors": they are no more line detectors than they are curve detectors. If our perception of a certain line or curve depends on simple or complex cells it presumably depends on a whole set of them, and how the information from such sets of cells is assembled at subsequent stages in the path, to build up what we call "percepts" of lines or curves (if indeed anything like that happens at all), is still a complete mystery.

## ARCHITECTURE

When I began my training in neurophysiology at Walter Reed I was lucky enough to be influenced by new and vigorous traditions of experimental neuroanatomy, represented by Walle Nauta, and by a new blend of neuroanatomy and neurophysiology represented at Walter Reed, Johns Hopkins, and the National Institutes of Health by (among others) Jerzy Rose, Vernon Mount-

castle, and Robert Galambos. One day very near the beginning of my term at Walter Reed, Jerzy Rose, on the steps of the Research Institute, very sternly told me that I had better make it my business to know exactly where my recording electrode was. I subsequently began to use the Hopkins - Walter Reed technique of making one electrode track or several parallel tracks through cortex, recording as many cells as possible in each track and then reconstructing the tracks from the histology. This made it possible to work out the response properties of single cells and also to learn how they were grouped. It was put to use most dramatically by Vernon Mountcastle, whose discovery of columns in the somatosensory cortex was surely the single most important contribution to the understanding of cerebral cortex since Cajal. Our addition to the reconstruction technique was the strategy of making multiple small (roughly 100  $\mu\text{m}$  diameter) electrolytic lesions along each track by passing small currents through the tungsten electrodes. I worked out this method at Walter Reed by watching the coagulation produced at the electrode tip on passing currents through egg white. The lesions made it possible to be sure of the positions of at least several points along a track; other positions were determined by interpolating depth readings of the microelectrode advancer.

By the early 1960s our research had extended into four different but overlapping areas. Closest to conventional neurophysiology was the working out of response properties (i.e. receptive fields) of single cells. We became increasingly involved with architecture, the grouping of cells according to function into layers and columns, studied by track reconstructions. This led in turn to experiments in which single-cell recording was combined with experimental anatomy. It began when one day James Sprague called to tell us that his chief histological technician, Jane Chen, was moving to Boston and needed a job: could we take her? Luckily we did, and so, despite our not possessing anatomical union cards, we acquired an expert in the Nauta method of making lesions in nervous tissue and selectively staining the degenerating axons. It seemed a terrible waste not to use this method and we soon got the idea of working out detailed pathways by making microelectrode lesions that were far smaller than conventional lesions and could be precisely placed by recording with the same electrodes. It became possible to make lesions in single layers of the lateral geniculate body, with results to be discussed shortly. Finally, still another phase of our work involved studies of newborn animals' postnatal development, and the effects of distorting normal sensory experience in young animals. This began in 1962 and grew steadily. Torsten Wiesel will discuss these experiments.

Having mentioned Jane Chen, this is perhaps as good a place as any to acknowledge our tremendous debt to many research assistants who have helped us over the past 22 years, especially to Jane and to Janet Wiitanen and Bea Storai, and also to Jaye Robinson, Martha Egan, Joan Weisenbeck, Karen Larson, Sharon Mates, Debra Hamburger, Yu-Wen Wu, Sue Fenstermaker, Stella Chow, Sarah Kennedy, Maureen Packard and Mary Nastuk. For photographic assistance I am grateful to Sandra Spinks, Carolyn Yoshikami and Marc Peloquin. In electronics and computers David Freeman has continued to

amaze us with his wizardry for 12 years. And for secretarial help and preservation of morale and sanity I want to thank Sheila Barton, Pat Schubert and Olivia Brum.

### ORIENTATION COLUMNS

What our three simultaneously recorded cells, Nos. 3009, 3010 and 3011, mapped out on the overhead sheet in September 1958, with their parallel orientation axes and separate but overlapping field positions, were telling us was that neighboring cells have similar orientations but slightly different

6<sup>a</sup>)

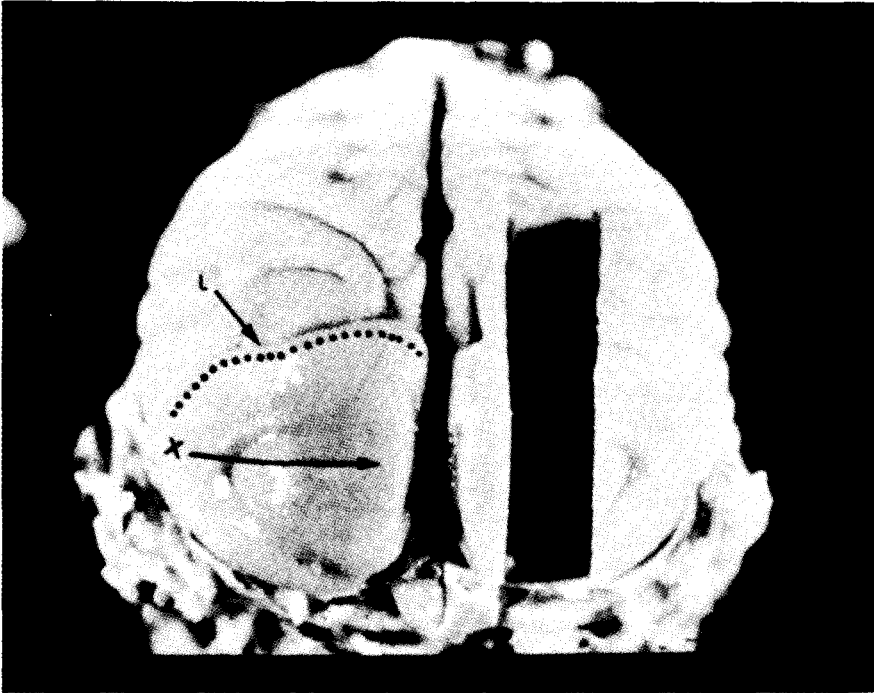
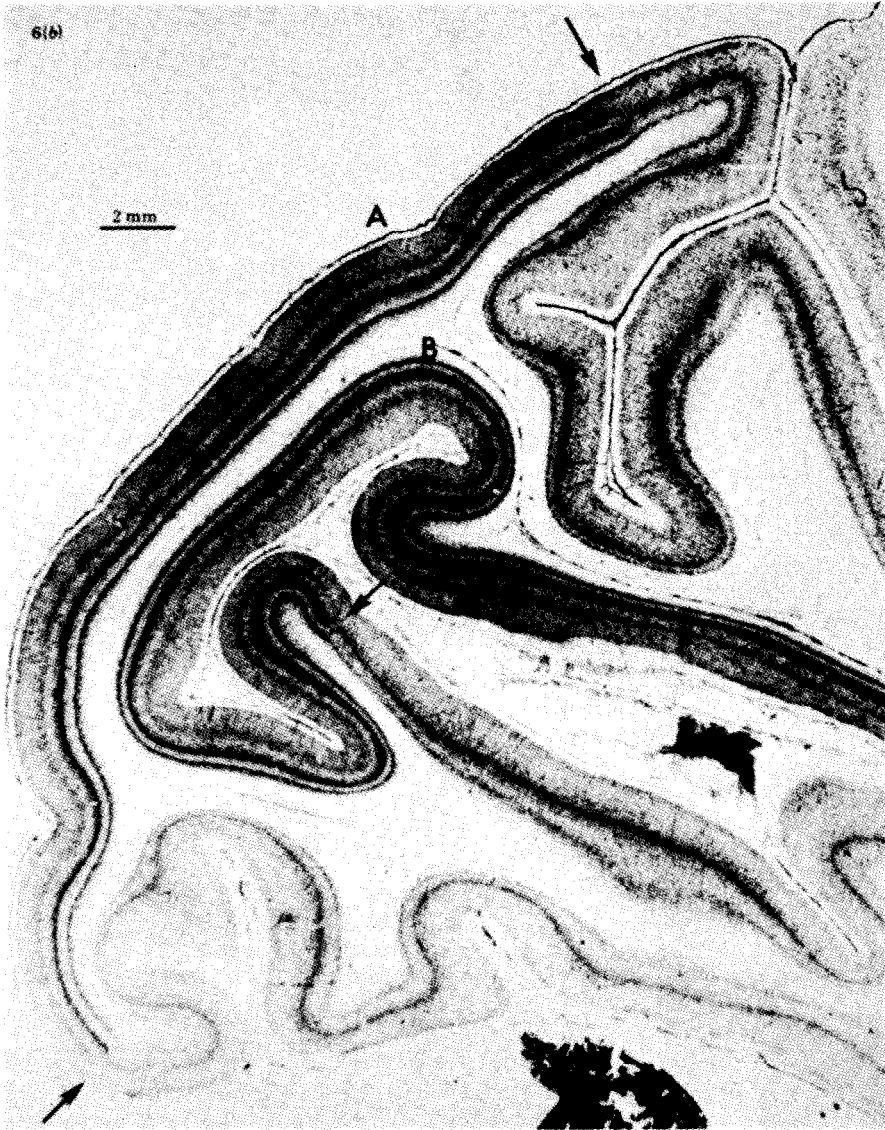

Figure 6. a) Brain of a macaque monkey, perfused with formalin, viewed from above and behind. The occipital lobe is demarcated in front by the lunate sulcus (L) and consists mainly of the striate cortex, area 17, which occupies most of the smooth surface, extending forward to the dotted line (the 17 - 18 border). If followed medially area 17 curves around the medial surface of the brain and continues in a complex buried fold, a part of which lies underneath the convexity and parallel to it. X marks the projection of the fovea; movement in the direction of the arrow corresponds to movement along the horizon; movement along the dotted line, to movement down along the vertical midline of the visual field. The brain on removal from the skull does not, of course, look exactly like this: the groove in the right hemisphere was made by removing a parasagittal block of tissue to produce the cross section of Fig. 6b. (Fig. 6a (29)).

b) Low power Nissl-stained section from a parasagittal block such as that of Fig. 6a. It is what would be seen if one could stand in the groove of 6a and look to the left. A marks the outer convexity; B the buried fold, and arrows indicate the 17 - 18 borders, the upper right one of which is indicated by the dotted line in Fig. 6a. (Fig. 6b (29)).

c) Cross section through monkey striate cortex showing conventional layering designations. W, white matter. Deeper layers (VI, V) of the buried fold of cortex are shown in the lower part of the figure (compare Fig. 6b). Cresyl violet. (Fig. 10 (29)).



receptive-field positions. We of course knew about our visitor Mountcastle's somatosensory columns, and we began to suspect that cells might be grouped in striate cortex according to orientation; but to prove it was not easy.

Our first indication of the beauty of the arrangements of cell groupings came in 1961 in one of our first recordings from striate cortex of monkey, a spider monkey named George. In one penetration, which went into the cortex at an angle of about  $45^\circ$  and was 2.5 mm long, we were struck right away by something we had only seen hints of before: as the electrode advanced the orientations of successively recorded cells progressed in small steps, of about  $10^\circ$  for every advance of  $50\ \mu\text{m}$ . We began the penetration around 8:00 p.m.; five hours later we had recorded 53 successive orientations without a single



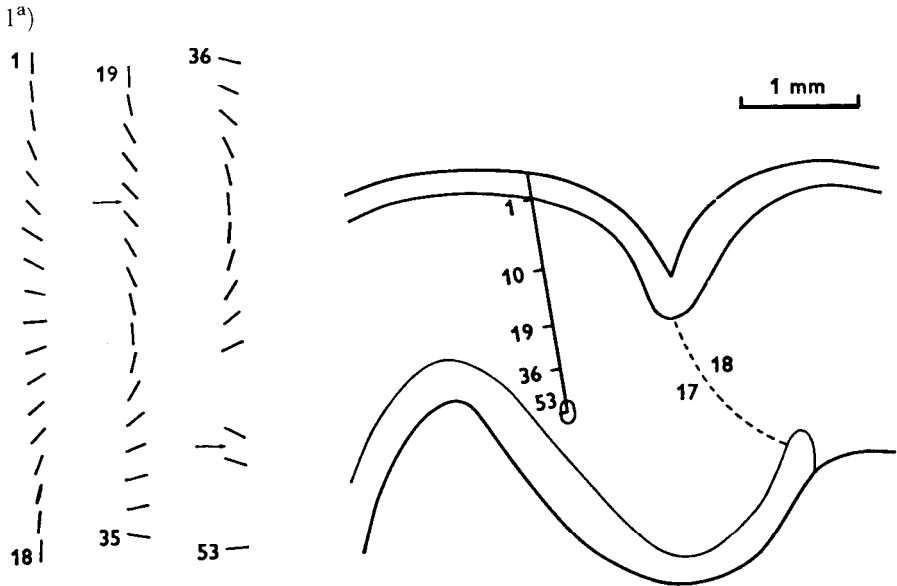
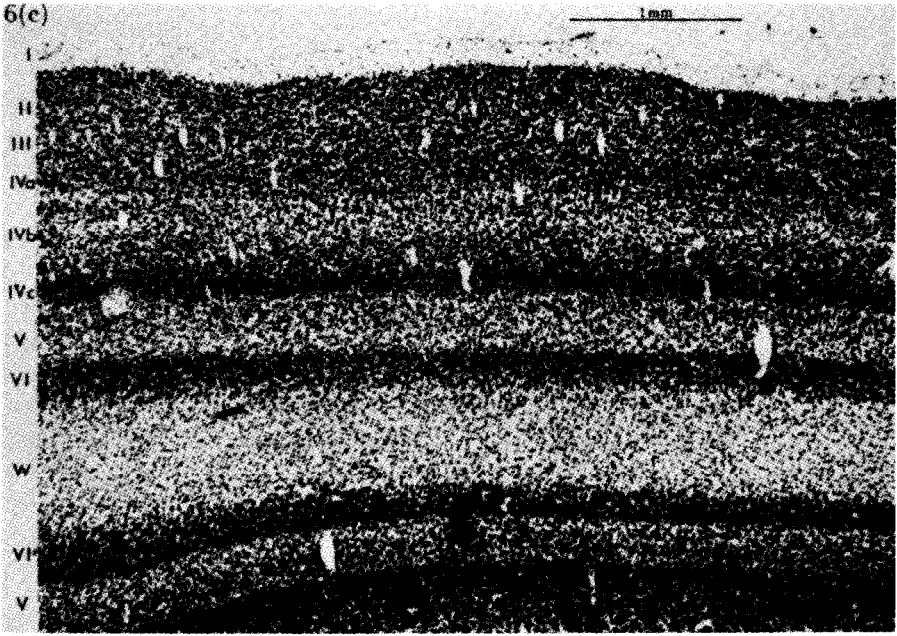
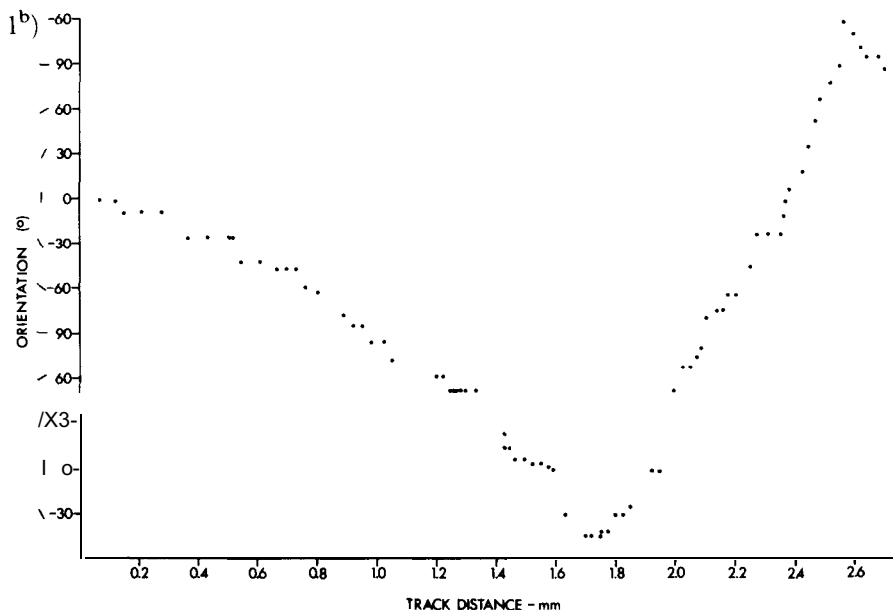

Figure 7. a) Reconstruction of a penetration through striate cortex about 1 mm from 17-18 border, near occipital pole of a spider monkey called George. To the left of the figure the lines indicate receptive-field orientations of cells in the columns traversed; each line represents one or several units recorded against a rich unresolved background activity. Arrows indicate reversal of directions of shifts in orientation (32).

b) Graph of stimulus orientation in degrees vs. distance along electrode track in mm, in the experiment shown in (a). Vertical is taken as 0°, clockwise is positive, anticlockwise negative.



large jump in orientation (Fig. 7). During the entire time, in which I wielded the slide projector and Torsten mapped the fields, neither of us moved from our seats. Fortunately our fluid intake that day had not been excessive! I have shown this illustration many times. So far only one person, Francis Crick, has asked why there was no interruption in layer IVc, where according to dogma the cells are not orientation-specific. The answer is that I don't know.

In the cat we had had occasional suggestions of similar orderliness, and so we decided to address directly the problem of the shape and arrangement of the groupings (18). By making several closely-spaced oblique parallel penetrations we convinced ourselves that the groupings were really columns in that they extended from surface to white matter and had walls that were perpendicular to the layers (Fig. 8). We next made multiple close-spaced penetrations, advancing the electrode just far enough in each penetration to record one cell or a group of cells. To map a few square mm of cortex this way required 50–100 penetrations, each of which took about 10–15 minutes. We decided it might be better to change careers, perhaps to chicken farming. But although the experiments were by our standards exhausting they did succeed in showing that orientation columns in the cat are not generally pillars but parallel slabs that intersect the surface either as straight parallel stripes or swirls (Fig. 9).

Reversals in direction of orientation shift, like those shown in Fig. 7, are found in most penetrations. They occur irregularly, on the average about once every millimeter, and not at any particular orientation such as vertical or horizontal. We still do not know how to interpret them. Between reversals the plots of orientation vs. electrode position are remarkably linear (19). I once, to exercise a new programmable calculator, actually determined the coefficient of linear correlation of such a graph. It was 0.998, which I took to mean that the line must be very straight indeed.

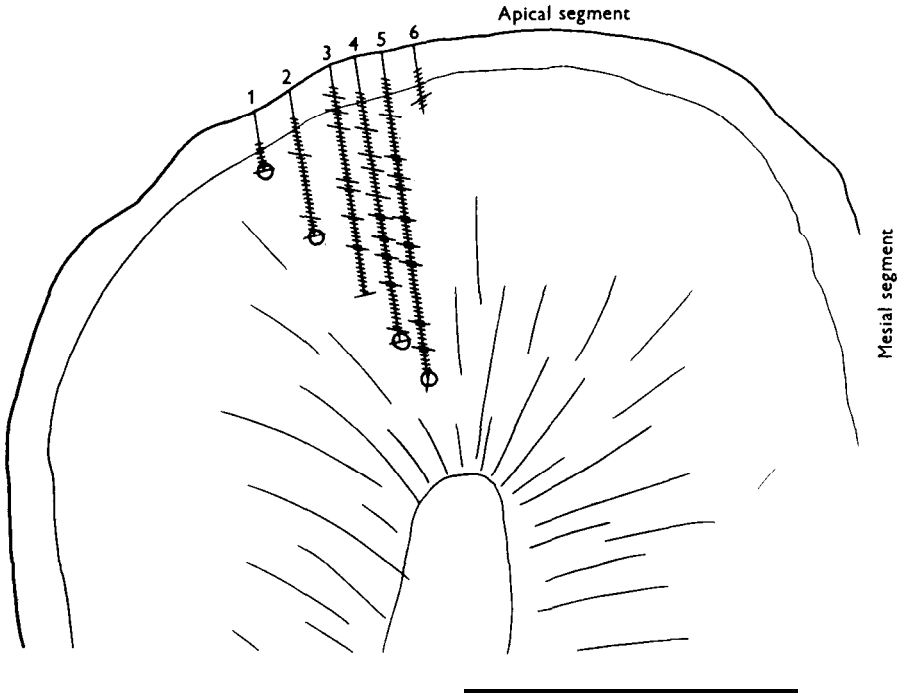

Figure 8. Coronal section through cat visual cortex showing reconstructions of 6 parallel microelectrode penetrations. (Nos. 1, 2, 4 and 5 end with lesions shown as circles.) Short lines perpendicular to tracks indicate receptive-field orientation; lines perpendicular to tracks represent horizontal orientation. (The longer of these lines represent single cells, the shorter ones, multiple unit recordings). Most of the territory traversed by penetrations 2-5 is in one orientation column, whose left hand border lies at the ends of tracks 2-4. Scale 1 mm. (Fig. 2 (18)).

For some years we had the impression that regular sequences like the one shown in Fig. 7 are rare - that most sequences are either more or less random or else the orientation hovers around one angle for some distance and then goes to a new angle and hovers there. Chaos and hovering do occur but they are exceptional, as are major jumps of 45-90°. It took us a long time to realize that regularity is the rule, not the exception, probably because only around the mid-1970s did we begin making very oblique or tangential penetrations. Also for these experiments to be successful requires electrodes coarse enough to record activity throughout a penetration, and not simply every 100  $\mu\text{m}$  or so. Such electrodes look less aesthetically pleasing, a fact that I think has happily tended to keep down competition.

Our attempts to learn more about the geometry of orientation columns in the monkey by using the 2-deoxyglucose technique (20) suggest that iso-orientation lines form a periodic pattern but are far from straight, being full of swirls and interruptions. Experiments done since then (21) suggest that the deoxyglucose is possibly also labelling the cytochrome blobs (see below). Similar work in the tree shrew by Humphrey (22) has shown a much more regular pattern and Stryker, Wiesel and I have seen more regularity in the cat (unpublished). Both tree shrew and cat lack the cytochrome blobs.

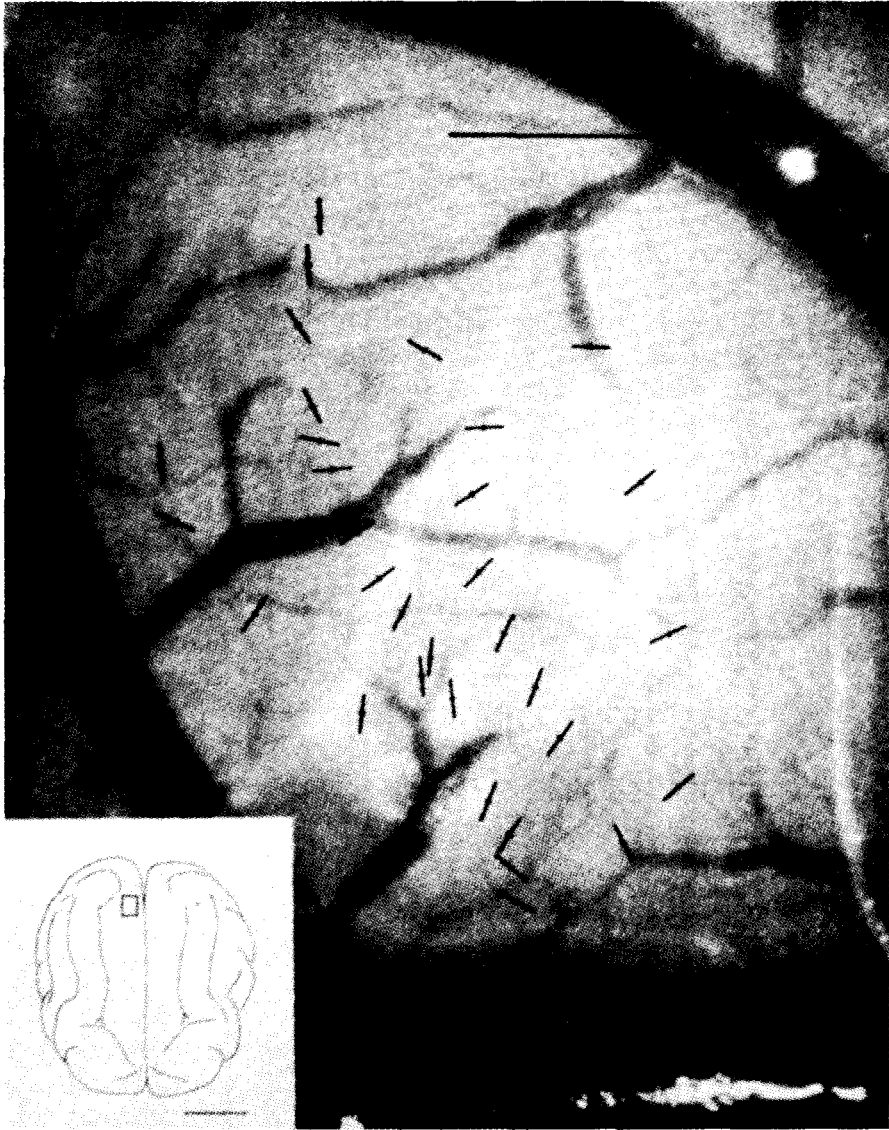

Figure 9. Surface map of a small region of cat visual cortex. Receptive field orientations are shown for 32 superficial penetrations. Regions of relatively constant orientation run more or less right-to-left in the figure, or media-lateral on the brain (see inset). Going from above down, in the figure, or from posterior to anterior of the brain, is associated with anticlockwise rotation. Scale 1 mm; inset scale 1 cm. (Plate 2 (18)).

### OCULAR DOMINANCE COLUMNS

A major finding in our 1959 and 1962 papers (10, 12), besides the orientation selectivity, was the presence in the striate cortex of a high proportion of binocular cells. Since recordings from the lateral geniculate body had made it clear that cells at that stage are for all practical purposes monocular, this answered the question of where, in the retinogeniculocortical pathway, cells

first received convergent input from the two eyes. More interesting to us than the mere binocularity was the similarity of a given cell's receptive fields in the two eyes, in size, complexity, orientation and position. Presumably this forms the basis of the fusion of the images in the two eyes. It still seems remarkable that a cell should not only be wired with the precision necessary to produce complex or hypercomplex properties, but should have a duplicate set of such connections, one from each eye. (That this is hard wired at birth will form some of the material for Torsten Wiesel's lecture.) Though the optimum stimulus is the same for the two eyes, the responses evoked are not necessarily equal; for a given cell one eye is often better than the other. It is as if the two sets of connections were qualitatively similar but, for many cells, different in density. We termed this relative effectiveness of the two eyes "eye preference" or "relative ocular dominance".

In the macaque it was evident from the earliest experiments that neighboring cells have similar eye preferences. In vertical penetrations the preference remains the same all the way through the cortex. Layer IVc, in which cells are monocular, is an exception; here the eye that above and below layer IV merely dominates the cells actually monopolizes them. In penetrations that run parallel to the layers there is an alternation of eye preference, with shifts roughly

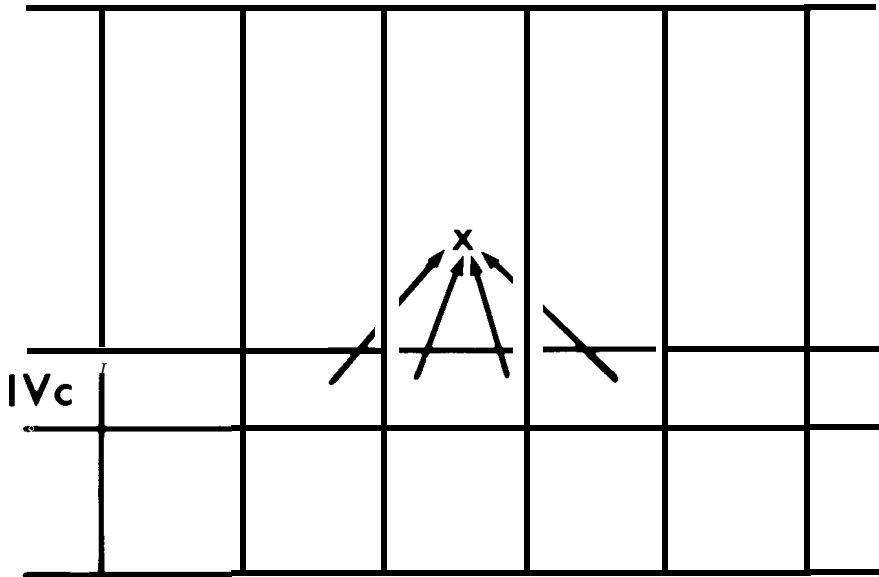

Figure 10. Scheme to illustrate the wiring of a binocular cell in a layer above (or below) layer IVc. The bulk of the afferents to the striate cortex from the lateral geniculate body, themselves monocular, are in the macaque monkey strictly segregated by eye affiliation in layer IVc, and thus the cells in this layer are strictly monocular. A cell outside of IVc, labelled X in the diagram, receives its input connections, directly or indirectly by one or more synapses, from cells in IVc (to some extent also, perhaps, from layers IVa and VI). Cells in IVc will be more likely to feed into X the closer they are to it; consequently X is likely to be binocular, dominated by the eye corresponding to the nearest patch in IVc. The degree of dominance by that eye is greater, the closer X is to being centered in its ocular dominance column, and cells near a boundary may be roughly equally influenced by the two eyes. (Fig. 12 (29)).

every 0.5 mm. The conclusion is that the terminals from cells of the lateral geniculate distribute themselves in layer IVc according to eye of origin, in alternating patches about 0.5 mm wide. In the layers above and below layer IV horizontal and diagonal connections lead to a mixing that is incomplete, so that a cell above a given patch is dominated by the eye supplying that patch but receives subsidiary input from neighboring patches (Fig. 10).

The geometry of these layer-IV patches interested us greatly, and was finally determined by several independent anatomical methods, the first of which involved the Nauta method and modifications of the Nauta method for staining terminals worked out first by Fink and Heimer and then by a most able and energetic research assistant, Janet Wiitanen (23). By making small lesions in single geniculate layers we were able to see the patchy distribution of degenerating terminals in layer IV, which in a face-on view takes the form not of circumscribed patches but of parallel stripes. We also showed that the ventral (magnocellular) pair of layers projects to the upper half of IVc, (subsequently called IVc  $\alpha$  by Jennifer Lund), whereas the dorsal 4 layers project to the lower half (IVc  $\beta$ ), and that the line of Gennari (IVb), once thought to receive the strongest projection, is actually almost bereft of geniculate terminals.

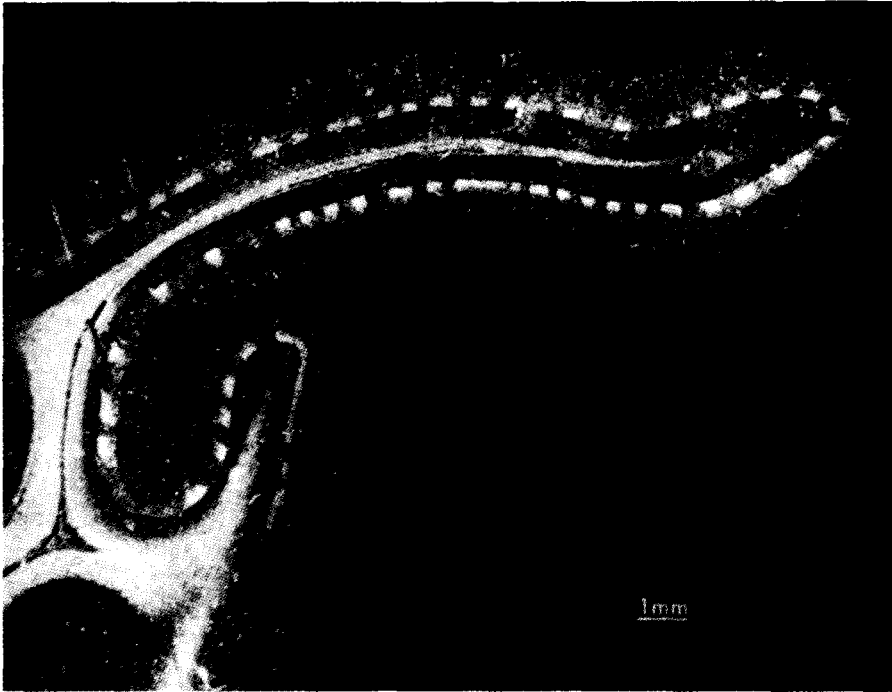

Figure 1 I. Dark-field autoradiograph of striate cortex in an adult macaque in which the ipsilateral eye had been injected with tritiated proline-fucose 2 weeks before. Labeled areas show as white. Section passes in a plane roughly perpendicular to the exposed surface of the occipital lobe, and to the buried part immediately beneath (roughly, through the arrow of Fig. 6a). In all, about 56 labelled patches can be seen. (Fig. 22 (29)).

While the Nauta studies were still in progress we read a paper in which Bernice Grafstein reported that after injecting a radioactive aminoacid into the eye of a rat, radioactive label could be detected in the contralateral visual cortex, as though transneuronal transport had taken place in the geniculate (24). (The rat retinogeniculocortical pathway is mainly crossed.) It occurred to us that if we injected the eye of a monkey we might be able to see label autoradiographically in area 17. We tried it, but could see nothing. Soon after, while visiting Ray Guillery in Wisconsin, I saw some aminoacid transport autoradiographs which showed nothing in light field but in which label was perfectly obvious in dark field. I rushed back, we got out our slides, borrowed a dark-field condenser, and found beautiful alternating patches throughout all the binocular part of area 17 (25) (Fig. 11). This method allowed us to reconstruct ocular dominance columns over much wider expanses than could be mapped with the Nauta method (Fig. 12). It led to a study of the pre- and postnatal visual development of ocular dominance columns, and the effects of visual deprivation on the columns, which Torsten will describe.

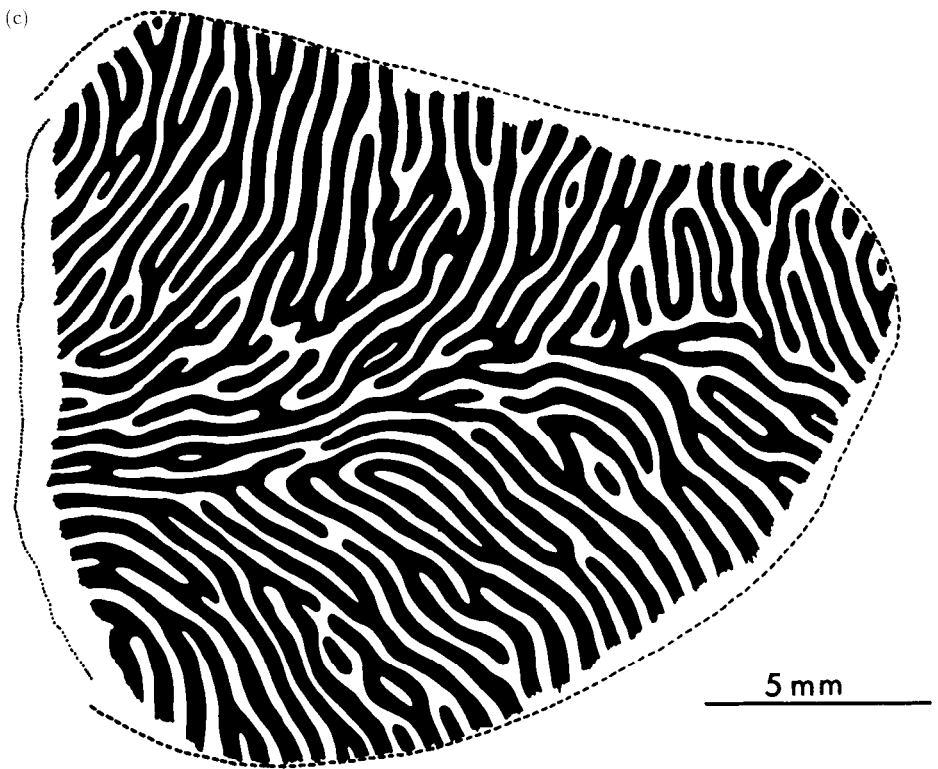
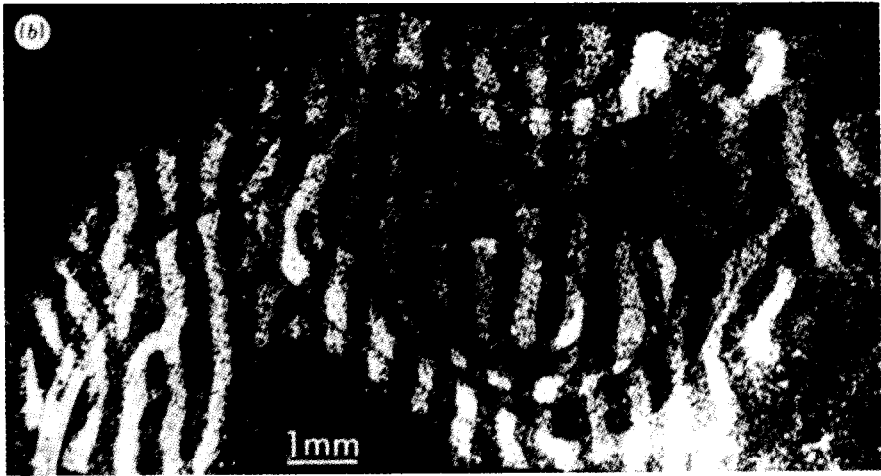

Figure 12. Autoradiographs from the same (normal) animal as Fig. 11, but hemisphere contralateral to the injected eye (dark field).

a) A section tangential to the exposed dome-like surface of the occipital lobe, just grazing layer V, which appears as an oval, surrounded by layer IVc, which appears as a ring containing the labelled parallel bands: these appear as light against the dark background.

b) A composite made by cutting out layer IVc from a number of parallel sections such as the one shown in (a), and pasting them together to show the bands over an area some millimeters in extent.

c) Reconstruction of layer IVc ocular dominance columns over the entire exposed part of area 17 in the right occipital lobe, made from a series of reduced-silver sections (33). The region represented is the same as the part of the right occipital lobe shown in Fig. 6a. Dotted line on the left represents the midsagittal plane where the cortex bends around. Dashed c-shaped curve is the 17-18 border, whose apex, to the extreme right, represents the fovea. Every other column has been blackened in, so as to exhibit the twofold nature of the set of subdivisions. Note the relative constancy of column widths.





## RELATIONSHIP BETWEEN COLUMNS, MAGNIFICATION AND FIELD SIZE

To me the main pleasures of doing science are in getting ideas for experiments, doing surgery, designing and making equipment, and above all the rare moments in which some apparently isolated facts click into place like a Chinese puzzle. When a collaboration works, as ours has, the ideas and the clicking into place often occur simultaneously or collaboratively; usually neither of us has known (or cared) exactly where or from whom ideas came from, and sometimes one idea has occurred to one of us, only to be forgotten and later resurrected by the other. One of the most exciting moments was the realization that our orientation columns, extending through the full thickness of the cat cortex, contain just those simple and complex cells (later we could add the hypercomplex) that our hierarchical schemes had proposed were interconnected (12). This gave the column a meaning: a little machine that takes care of contours in a certain orientation in a certain part of the visual field. If the cells of one set are to be interconnected, and to some extent isolated from neighboring sets, it makes obvious sense to gather them together. As Lorente de N6 showed (26), most of the connections in the cortex run in an up-and-down direction; lateral or oblique connections tend to be short (mostly limited to 1 to 2 mm) and less rich. These ideas were not entirely new, since Mountcastle had clearly enunciated the principle of the column as an independent unit of function. What was new in the visual cortex was a clear function, the transformation of information from circularly symmetric form to orientation-specific form, and the stepwise increase in complexity.

A similar argument applies to the ocular dominance columns, a pair of which constitutes a machine for combining inputs from the two eyes—combining, but not completely combining, in a peculiar grudging way and for reasons still not at all clear, but probably related in some way to stereopsis. (Whatever the explanation of the systematically incomplete blending, it will have to take into account the virtual but not complete absence of dominance columns in squirrel monkeys.) If the eyes are to be kept functionally to some extent separate, it is economical of connections to pack together cells of a given eye preference.

To my mind our most aesthetically attractive and exciting formulation has been the hypercolumn (not, I admit, a very attractive term!) and its relation to magnification. The idea grew up gradually, but took an initial spurt as a result of a question asked by Werner Reichardt during a seminar that I gave in Tübingen. I had been describing the ordered orientation sequences found in monkeys like George, when Werner asked how one avoided the difficulty arising from the fact that as you move across the cortex visual field position is changing, in addition to orientation. Could this mean that if you looked closely you would find, in one small part of the visual field, only a small select group of orientations represented? The answer seemed obvious: I explained that in any one part of the visual field all orientations are represented, in fact probably several times over. Afterwards the question nagged me. There must be more to it than that. We began to put some seemingly isolated facts together. The visual

fields map systematically onto the cortex but the map is distorted: the fovea is disproportionately represented, with 1 mm about equivalent to  $1/6^\circ$  of visual field. As one goes out in the visual field the representation falls off, logarithmically, as Daniel and Whitteridge had shown (27), so that in the far periphery the relationship is more like  $1 \text{ mm} = 6^\circ$ . Meanwhile the average size of receptive fields grows from center of gaze to periphery. This is not unexpected when one considers that in the fovea our acuity is very much higher than in the periphery. To do the job in more detail takes more cells, each looking after a smaller region; to accommodate the cells takes more cortical surface area. I had always been surprised that the part of the cortex representing the fovea is not obviously thicker than that representing the periphery: the surprise, I suppose, comes from the fact that in the retina near the fovea the ganglion cell layer is many times thicker than in the periphery. The cortex must be going out of its

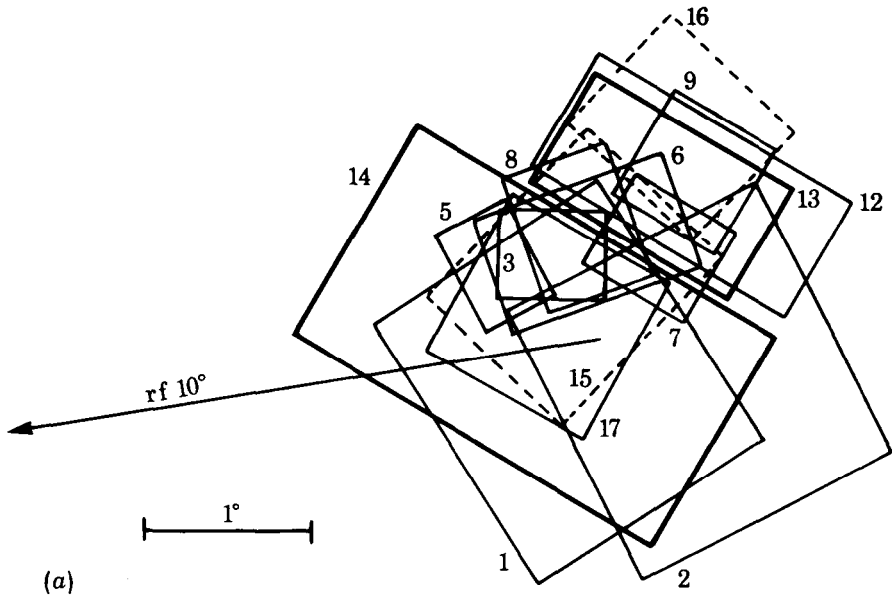
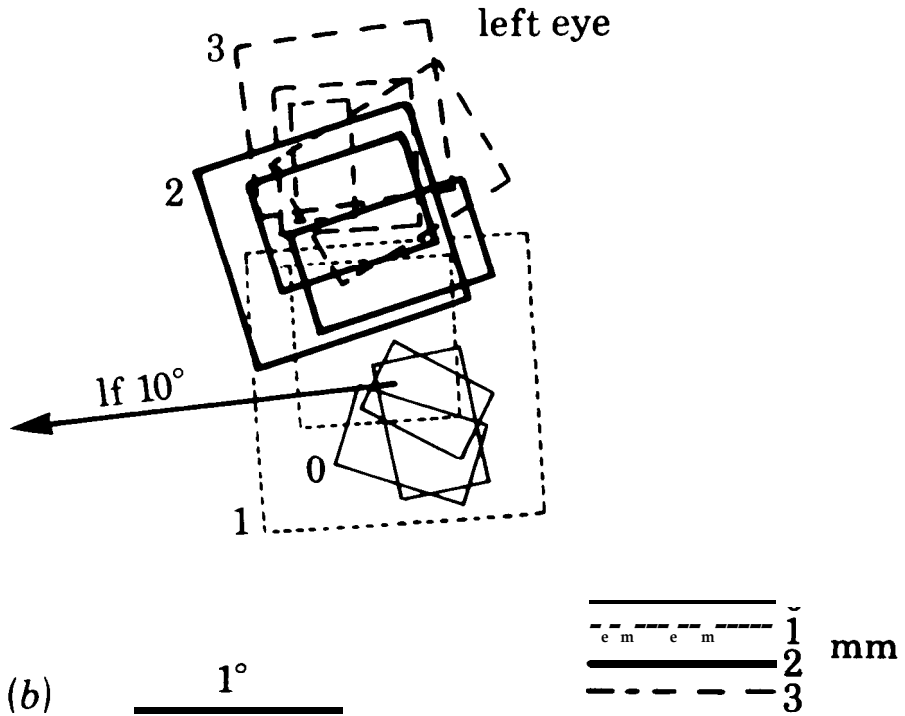

Figure 13. a) Receptive-field scatter: Receptive field boundaries of 17 cells recorded in a penetration through monkey striate cortex in a direction perpendicular to the surface. Note the variation in size, and the more or less random scatter in the precise positions of the fields. The penetration was made in a part of the cortex corresponding to a visual field location  $10^\circ$  from the center of gaze, just above the horizontal meridian. Fields are shown for one eye only. Numbers indicate the order in which the cells were recorded. (Fig. 1 (28)).

b) Receptive-field drift: Receptive fields mapped during one oblique, almost tangential penetration through striate cortex, in roughly the same region as in (a). A few fields were mapped along each of four  $100 \mu\text{m}$  segments, spaced at 1 mm intervals. These four groups of fields are labelled 0, 1, 2 and 3. Each new set of fields was slightly above the other, in the visual field, as predicted from the direction of movement of the electrode and from the topographic map of visual fields onto cortex. Roughly a 2 mm movement through cortex was required to displace the fields from one region to an entirely new region. (Fig. 2 (28)).



way to keep its uniformity by devoting to the detailed tasks more area rather than more thickness.

We decided to look more carefully at the relationship between receptive-field size and area of cortex per unit area of visual field (28). When an electrode is pushed vertically through the cortex and encounters a hundred or so cells in traversing the full thickness, the receptive fields vary to some extent in size, and in a rather random way in position, so that the hundred maps when superimposed cover an area several times that of an average receptive field (Fig. 13a). We call this the "aggregate receptive field" for a particular point on the cortex. On making a penetration parallel to the surface there is a gradual drift in field position, superimposed on the random staggering, in a direction dictated by the topographic map (Fig. 13b). We began to wonder whether there was any law connecting the rate of this drift in aggregate position and the size of the fields. It was easy to get a direct answer. It turned out that a movement of about 2 mm across the cortex is just sufficient to produce a displacement, in the visual field, out of the region where one started and into an entirely new region. This held everywhere across the striate cortex (and consequently in the visual field). In the fovea the displacement was tiny and so were the fields. As one went out, both increased in size, in parallel fashion (Fig. 14). Now things indeed seemed to mesh. George and other monkeys had taught us that a 1-2 mm movement across cortex is accompanied by an angular shift in receptive-field orientation of 180-360°, more than one full complement of orientations. We have termed such a set of orientation columns (180°) a "hypercolumn". Meanwhile, the

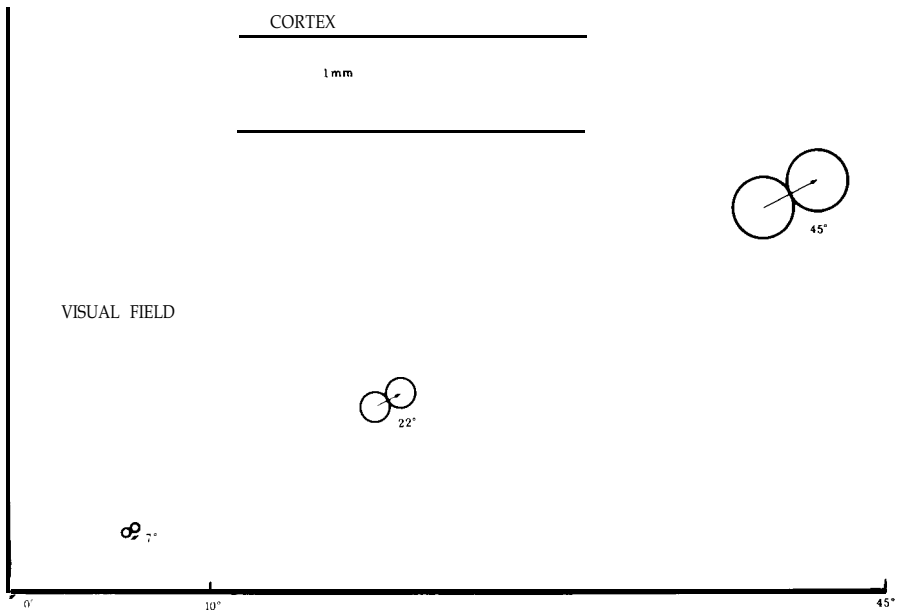

Figure 14. Variation of receptive-field drift with eccentricity: The diagram represents one quadrant of the field of vision, and the circles represent aggregate receptive fields, the territory collectively occupied by respective fields of cells encountered in a microelectrode penetration perpendicular to the cortical surface. Each pair of circles illustrates the movement in aggregate receptive field accompanying a movement along the cortex of 1-2 mm. Both the displacement and the aggregate field size vary with distance from the fovea (eccentricity), but they do so in parallel fashion. Close to the fovea the fields are tiny, but so is the displacement accompanying a 1-2 mm movement along the cortex. The greater the distance from the fovea, the greater the two become, but they continue to remain roughly equal (28).

ocular dominance shifts back and forth so as to take care of both eyes every millimeter - a hypercolumn for ocular dominance. Thus, in one or two square millimeters there seems to exist all the machinery necessary to look after everything the visual cortex is responsible for, in a certain small part of the visual world. The machines are the same everywhere; in some parts the information on which they do their job is less detailed, but covers more visual field (Fig. 15).

Uniformity is surely a huge advantage in development, for genetic specifications need only be laid down for a 1-2 mm block of neural tissue, together with the instruction to make a thousand or so.

We could, incidentally, have called the entire machine a hypercolumn, but we did not. The term as we define it refers to a complete set of columns of one type. I mention this because uniformity has obvious advantages, not just for the cortex but also for terminology. Perhaps one could use "module" to refer to the complete machine.

There are two qualifications to all of this. I do not mean to imply that there need really be 2,000 separate definable entities. It need not matter whether one begins a set of orientation columns at vertical, horizontal or any one of the

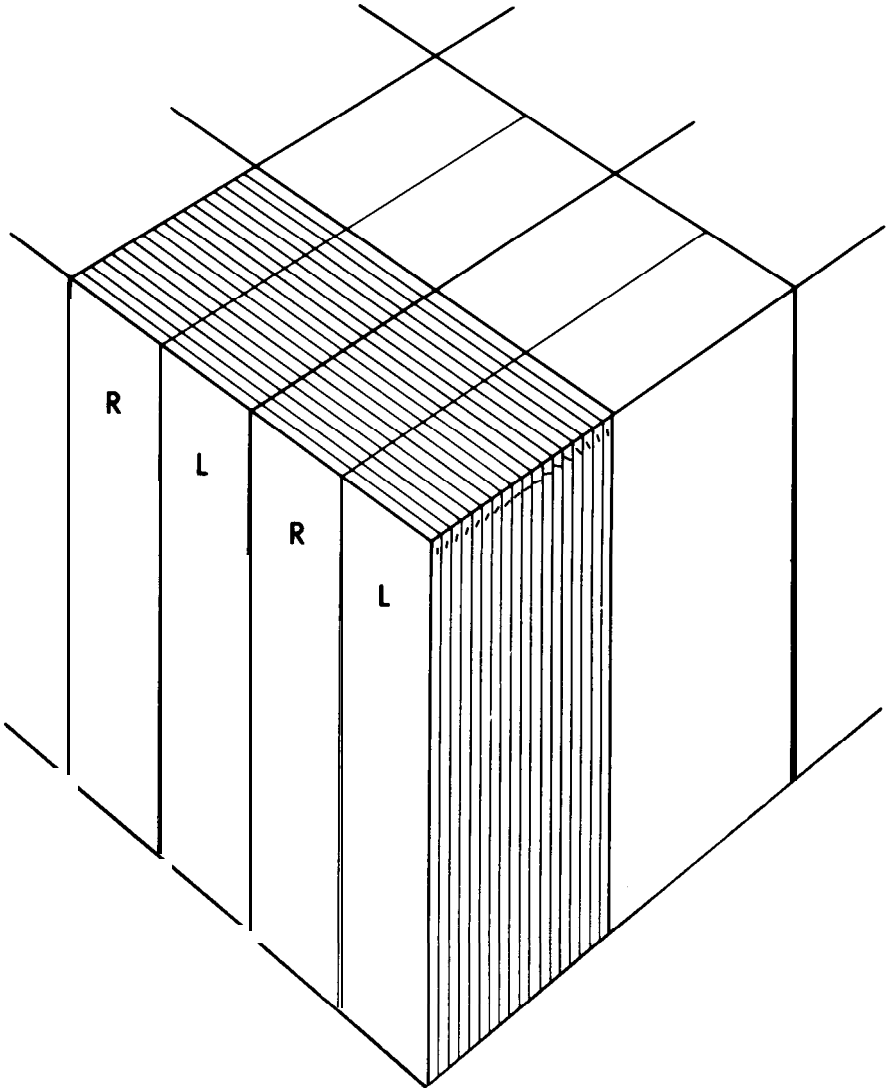

Figure 15. Model of the striate cortex, to show roughly the dimensions of the ocular dominance slabs (L,R) in relation to the orientation slabs and the cortical thickness. Thinner lines separate individual columns; thicker lines demarcate the two types of hypercolumn: two pairs of ocular dominance columns and two sets of orientation columns. The placing of these hypercolumn boundaries is of course arbitrary; one could as well begin the orientation hypercolumn at horizontal or any of the obliques. The decision to show the two sets of columns as intersecting at right angles is also arbitrary, since there is at present no evidence as to the relationship between the two sets. Finally, for convenience the slabs are shown as plane surfaces, but whereas the dominance columns are indeed more or less flat, the orientation columns are not known to be so, and may when viewed from above have the form of swirls. (Fig. 27 (29)).

obliques; the decision is arbitrary. One requires two dominance columns, a left and a right, and it makes no difference which one begins with. (In fact, as I will soon point out, it now looks as though the blocks of tissue may really be discrete, to a degree that we could not have imagined two years ago.) Second, there may well be some differences in cortical machinery between the center and periphery of the visual field. Color vision and stereopsis, for example, probably decline in importance far out in the visual fields. I say this not to be obsessively complete but because in the next few years someone will probably find some difference and pronounce the concept wrong. It may of course be wrong, but I hope it will be for interesting reasons.

I should perhaps point out that the retina must be nonuniform if it is to do a more detailed job in the center. To have more area devoted to the center than to the periphery is not an option open to it, because it is a globe. Were it anything else the optics would be awkward and the eye could not rotate in its socket.

A few years ago, in a Ferrier Lecture (29), Torsten and I ended by saying that the striate cortex is probably now (was, then) in broad outline, understood. This was done deliberately: one did not want the well to dry up. When one wants rain the best strategy is to leave raincoat and umbrella at home. So the best way to guarantee future employment was to declare the job finished. It certainly worked. Two years ago Anita Hendrickson and her coworkers and our laboratory independently discovered that monkey striate cortex, when sectioned parallel to the surface and through layers II and III and stained for the enzyme cytochrome oxidase, shows a polka-dot pattern of dark blobs quasi-regularly spaced 1/2- 1 mm apart (Fig. 16) (30,21). It is as if the animal's brain had the measles. The pattern has been seen with several other enzymatic stains, suggesting that either the activity or the machinery is different in the blob regions. The pattern has been found in all primates examined, including man, but not in any nonprimates. In macaque the blobs are clearly lined up along ocular dominance columns (19). Over the past year Margaret Livingstone and I have shown that the cells in the blobs lack orientation selectivity, resembling, at least superficially, cells of layer IVc (31). They are selectively labeled after large injections of radioactive proline into the lateral geniculate body, so it is clear that their inputs are not identical to the inputs to the rest of layers II and III. Thus, an entire system has opened up whose existence we were previously quite unaware of and whose anatomy and functions we do not yet understand. We are especially anxious to learn what, if any, the relationship is between the cytochrome blobs and the orientation columns.

Things are at an exciting stage. There is no point leaving the umbrella home; it is raining, and raining hard.

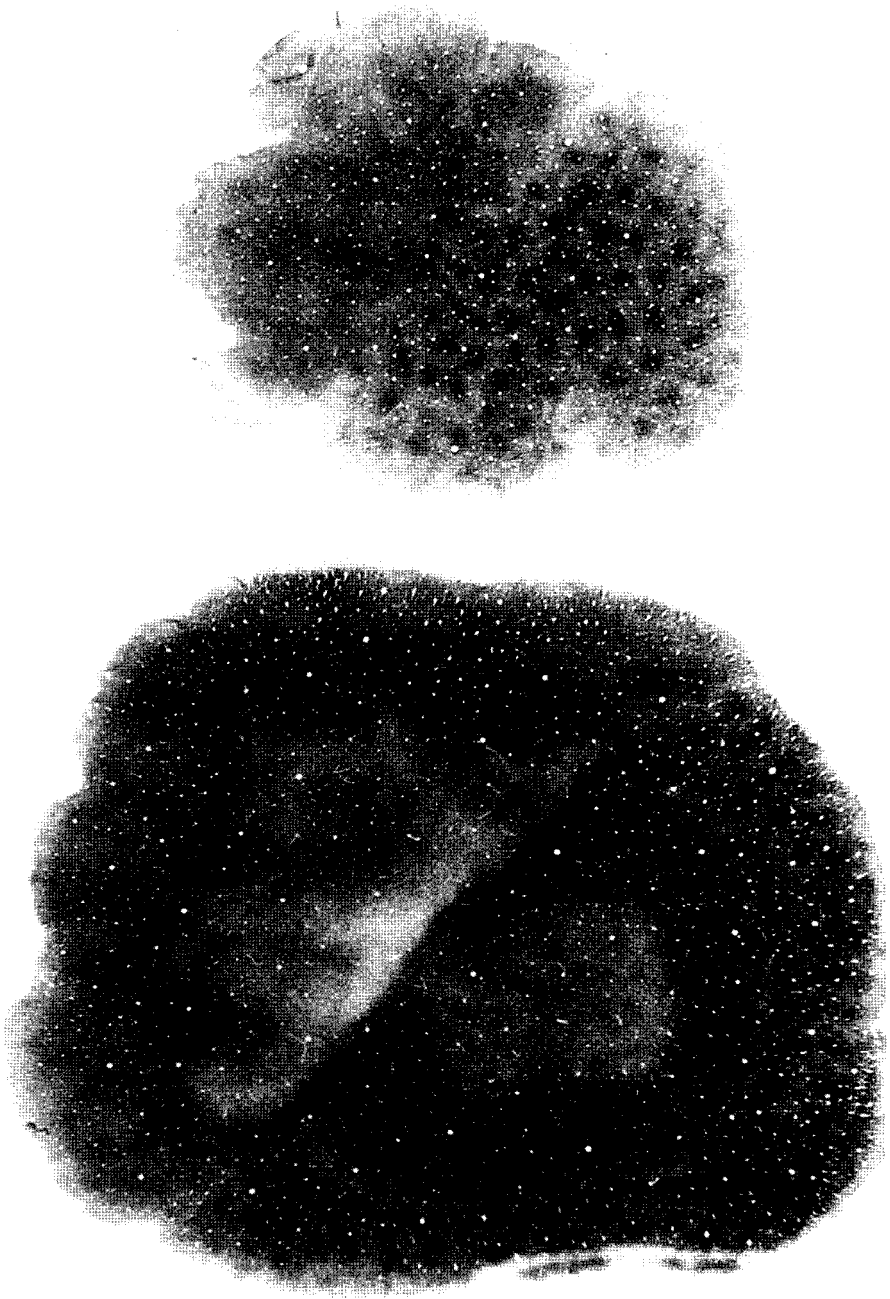

Figure 16. Tangential sections through the visual cortex of the squirrel monkey; cytochrome oxidase stain. The sections pass through the 17-18 border, which runs obliquely in the figure with area 17 below and to the right and 18 above and left. (Hubel and Livingstone, unpublished) The left-hand section passes through layer III, and the blobs can be seen easily in area 17. The right-hand section is tangential to layer V where blobs can be again seen, though faintly; these lie in register with the upper-layer blobs. The coarse pattern in area 18 is now under study and promises to be interesting.

## REFERENCES

1. Hubel, D. H., (1958) Cortical unit responses to visual stimuli in nonanesthetized cats. *Amer. J. Ophthalmol.* 46:110-122.
2. Barlow, H. B., FitzHugh, R. and Kuffler, S. W., (1957) Dark adaptation, absolute threshold and Purkinje shift in single units of the cat's retina. *J. Physiol.* 137: 327-337.
3. Talbot, S. A. and Kuffler, S. W., (1952) A multibeam ophthalmoscope for the study of retinal physiology. *J. Opt. Soc. Am.* 42:931-936.
4. Talbot, S. A. and Marshall, W. H., (1941) Physiological studies on neural mechanisms of visual localization and discrimination. *Am. J. Ophthalmol.* 24:1255-1263.
5. Mountcastle, V. B., (1957) Modality and topographic properties of single neurons of cat's somatic sensory cortex. *J. Neurophysiol.* 20:408-434.
6. Davies, P. W., (1956) Chamber for microelectrode studies in the cerebral cortex. *Science* 124: 179-180.
7. Sperry, R. W., Miner, N., and Meyers, R. E., (1955) Visual pattern perception following subpial slicing and tantalum wire implantations in the visual cortex. *J. Comp. Physiol. Psych.* 48:50-58.
8. Sperry, R. W. and Miner, N., (1955) Pattern perception following insertion of mica plates into visual cortex. *J. Comp. Physiol. Psych.* 48:463-469.
9. Hubel, D. H. and Wiesel, T. N., (1959) Respective field organization of single units in the striate cortex of cat. *XXI Int. Congr. Physiol. Sci.* Buenos Aires, p.131.
10. Hubel, D. H. and Wiesel, T. N., (1959) Receptive fields of single neurones in the cat's striate cortex. *J. Physiol.* 148:574-591.
11. Cleland, B. G., Dubin, M. W., and Levick, W. R., (1971) Simultaneous recording of input and output of lateral geniculate neurones. *Nature New Biol.* 231:191-192.
12. Hubel, D. H. and Wiesel, T. N., (1962) Receptive fields. binocular interaction and functional architecture in the cat's visual cortex. *J. Physiol.* 160:106-154.
13. Barlow, H. B. and Levick, W. R., (1965) The mechanism of directionally selective units in rabbit's retina. *J. Physiol.* 178:477-504.
14. Hubel, D. H. and Wiesel, T. N., (1965) Receptive fields and functional architecture in two non-striate visual areas (18 and 19) of the cat. *J. Neurophysiol.* 28:229-289.
15. Dreher, B. (1972) Hypercomplex cells in the cat's striate cortex. *Invest. Ophthalmol.* 11:355-356.
16. Gilbert, C. D. (1977) Laminar differences in receptive field properties of cells in cat visual cortex. *J. Physiol.* 268:391-421.
17. Toyama, K., Matsunami, K., and Ohno, T., (1969) Antidromic identification of association, commissural and corticofugal efferent cells in cat visual cortex. *Brain Res.* 14:513-517.
18. Hubel, D. H. and Wiesel, T. N., (1963) Shape and arrangement of columns in cat's striate cortex. *J. Physiol.* 165:559-568.
19. Hubel, D. H. and Wiesel, T. N., (1974) Sequence regularity and geometry of orientation columns in the monkey striate cortex. *J. Comp. Neur.* 158:267-294.
20. Sokoloff, L., Reivich, M., Kennedy, C., DesRosiers, M. H., Patlak, C. S., Pettigrew, K. D., Sakurada, O. and Shinohara, M., (1977) The [<sup>14</sup>C] deoxyglucose method for the measurement of local cerebral glucose utilization: theory, procedure, and normal values in the conscious and anesthetized albino rat. *J. Neurochem.* 28:897-916.
21. Horton, J. C. and Hubel, D. H., (1981) Regular patchy distribution of cytochrome oxidase staining in primary visual cortex of macaque monkey. *Nature* 292:762-764.
22. Humphrey, A. L., Skeen, L. G., and Norton, T. T., (1980) Topographic organization of the orientation column system in the striate cortex of the tree shrew (*Tupaia glis*). II. Deoxyglucose mapping. *J. Comp. Neur.* 192:549-566.
23. Hubel, D. H. and Wiesel, T. N., (1972) Laminar and columnar distribution of geniculocortical fibers in the macaque monkey. *J. Comp. Neur.* 146:421-450.
24. Grafstein, B. (1971) Transneuronal transfer of radioactivity in the central nervous system. *Science* 172:177-179.



25. Wiesel, T. N., Hubel, D. H., and Lam, D. M. K., (1974) Autoradiographic demonstration of ocular-dominance columns in the monkey striate cortex by means of transneuronal transport. *Brain Res.* 79:273-279.
26. Lorente de N6, R. (1949) Cerebral cortex: architecture, intracortical connections, motor projections. Chapt. 15 in Fulton, J. F.: *Physiology of the Nervous System*. 3rd edition, Oxford University Press, New York and London.
27. Daniel, P. M. and Whitteridge, D., (1961) The representation of the visual field on the cerebral cortex in monkeys. *J. Physiol., Lond.* 159:203-221.
28. Hubel, D. H. and Wiesel, T. N., (1974) Uniformity of monkey striate cortex: a parallel relationship between field size, scatter, and magnification factor. *J. Comp. Neur.* 158:295-306.
29. Hubel, D. H. and Wiesel, T. N., (1977) Ferrier Lecture. Functional architecture of macaque monkey visual cortex. *Proc. R. Soc. Lond. B.* 198:1-59.
30. Hendrickson, A. E., Hunt, S. P., and Wu, J.-Y., (1981) Immunocytochemical localization of glutamic acid decarboxylase in monkey striate cortex. *Nature* 292:605-607.
31. Hubel, D. H. and Livingstone, M. S., (1981) Regions of poor orientation tuning coincide with patches of cytochrome oxidase staining in monkey striate cortex. *Neurosci. Abst.* 11th Ann. Meeting, Los Angeles, 118.12.
32. Hubel, D. H. and Wiesel, T. N., (1968) Receptive fields and functional architecture of monkey striate cortex. *J. Physiol.* 195:215-243.
33. LeVay, S., Hubel, D. H., and Wiesel, T. N., (1975) The pattern of ocular dominance columns in macaque visual cortex revealed by a reduced silver stain. *J. Comp. Neur.* 159:559-576.