

JAROSLAV HEYROVSKÝ

The trends of polarography

Nobel Lecture, December 11, 1959

The reason why I keep some 38 years to the electrochemical researches with the dropping mercury electrode is its exquisite property as electrode material. Its physical conditions of dropping as well as the chemical changes during the passage of the electric current are well defined, and the phenomena displayed at the dropping mercury electrode proceed with strict reproducibility. Owing to the latter property the processes at the electrode can be exactly expressed mathematically. According to the registering apparatus called "polarograph", which draws automatically curves characteristic of the electrode processes, the electrochemical studies with the dropping mercury electrode and the analytical methods developed on these investigations have been called "polarography".

The capillary electrode is normally a 8 cm long, 5-6 mm thick tube with the inner bore of 0.05 to 0.1 mm, from which the drops of mercury fall off every 3 to 6 seconds according to the height of the mercury reservoir which is about 40 cm above the tip of the capillary (Fig. 1).

In order that the current passing through this electrode be entirely given by the composition of the solution surrounding it, the second electrode has to be indifferent, unpolarizable, of a constant potential; most suitably it is the layer of mercury at the bottom of the electrolytic vessel (Fig. 2).

To apply the external voltage to the cell we use a potentiometric arrangement shown in Fig. 2. From a 2 or 4 volt lead accumulator an increasing voltage (E) is branched off and the corresponding current is determined by the deflexion of the galvanometer. In such an arrangement the whole applied voltage, E , acts at the small polarizable electrode and determines its potential. The solution has to be conductive by an (about 0.1 N) indifferent electrolyte. Until the year 1924 the galvanometer deflexions were plotted by hand on the ordinate against the voltage applied by pushing the wheel of the Kohlrausch drum to different values. It took a couple of hours to obtain a full graph, point by point from 0 to 2 V. To accelerate the plotting of the curves we have constructed with Shikata in 1924 an automatic device, the "polarograph" (Fig. 3) by rotating the Kohlrausch drum mechanically, and syn-

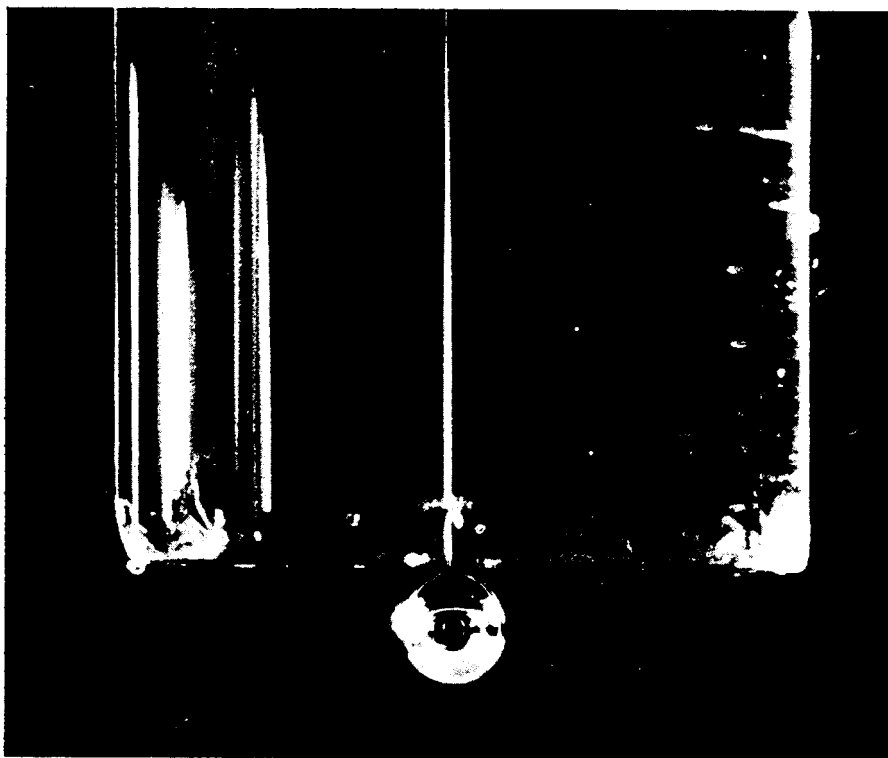

Fig. 1. Mouth of the dropping mercury electrode.

chronously moving also a photographic paper. This mechanism draws the current-voltage diagram (the "polarogram") in less than 10 minutes with all the advantages of automatic recording. The galvanometer has to be damped to register, instead of the instantaneous current, the mean current during each drop. It is not advisable to damp the motion of the galvanometer mirror so far that the oscillations disappear; the regularity of the oscillations is a good check of the right functioning of the apparatus (Fig. 4).

Next, the forms of the current-voltage curves were classified according to the various processes occurring at the dropping electrode. The most fundamental of these is the "charging current" which accompanies every drop-formation conveying to the drop the charge corresponding to the externally applied potential. As this charge depends on the capacity of the dropping electrode and does not involve any electrolytic changes, the current is also termed "capacity current" or "nonfaradayic current" (Fig. 5). It is very small, of the order of 10^{-7} amp pro volt and ordinarily is regarded as

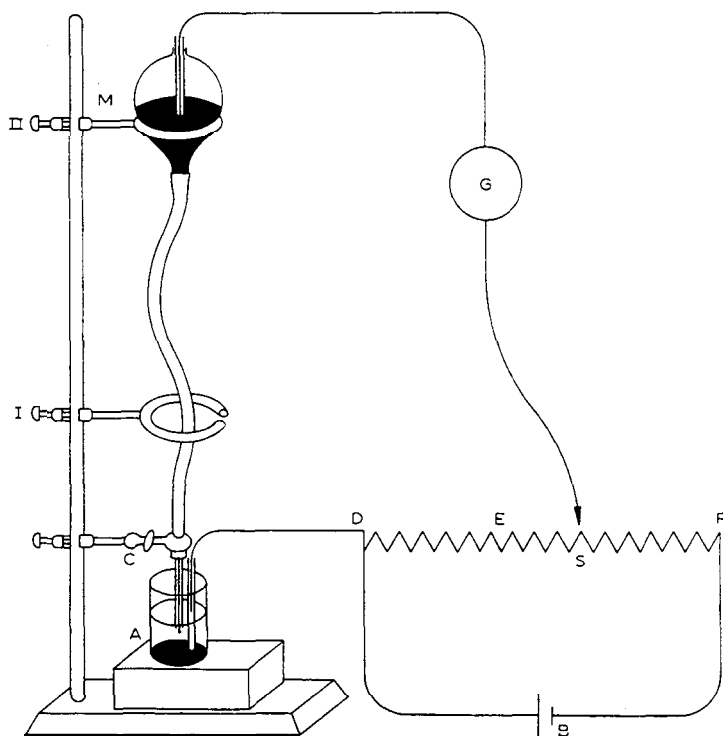

Fig. 2. Simplest polarographic arrangement.

negligible. However, the charging current plays an important role in oscillographic polarography where it is considerably greater. At a certain potential an electrolytic process starts, reduction or oxidation, which is shown by the passage of the current due to electrolysis. In the simplest case molecules or ions of the reducible or oxidizable substances interchange electrons with the electrode and hereby are removed from the electrode surface. Then new molecules of the electroactive substance - the depolarizer - diffuse from the interior of the solution to the surface of the electrode. **Ilkovič**² has calculated the current governed by diffusion to the surface of the expanding drop, deducing (in 1933) the formula of the "diffusion current":

$$i_a = 0.627 nF \cdot D^{1/2} m^{2/3} t^{1/6} C$$

where n is the number of electrons involved in the reaction, F the charge of Faraday, D the diffusion constant, m the rate of flow of mercury through the capillary, t the drop-time, and C the concentration of the depolarizer. This

is the most exact electrochemical law announced since Faraday's laws in 1833. When corrected for spherical diffusion according to Koutecký³, the agreement with experimental results is complete. Fig. 6 gives the reproducibility of a polarogram showing the diffusion current due to atmospheric oxygen in an alkaline solution.

Basing on this law the equations for the current-voltage curves due to the reductions and oxidations of depolarizers were deduced, from which the rule of constancy of the half-wave potentials, $E_{1/2}$, follows⁴. These values introduced new electrochemical constants (Figs. 7, 8) which have their thermodynamic significance giving affinities of electrode reactions. Also constants of complexes can be derived from such equations⁵ (Fig. 9).

In 1943 Wiesner⁶ discovered another sort of currents controlled by the rate of the chemical reaction yielding the depolarizer at the electrode. For example, formaldehyde or glucose give at ordinary temperature much smaller waves than expected from the Ilkovič formula (Fig. 10). Evidently a

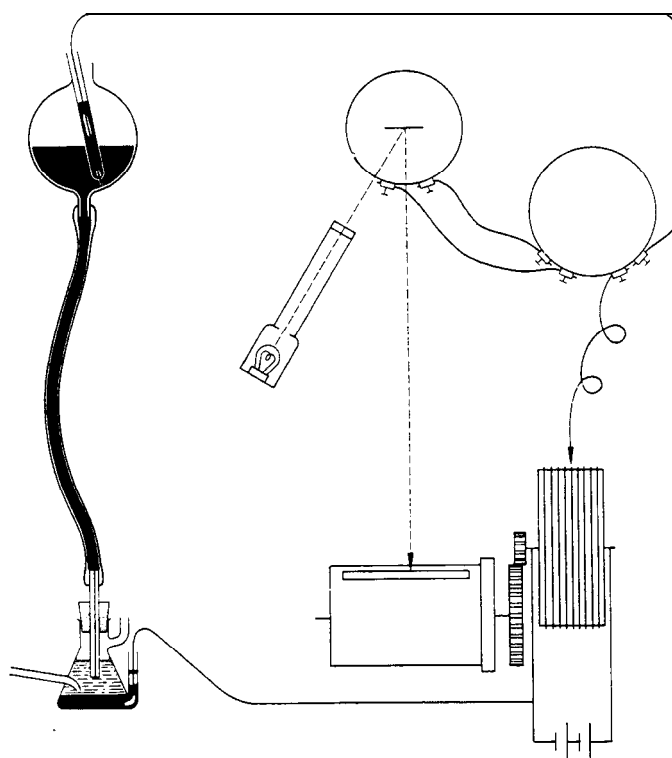

Fig. 3. Scheme of the polarograph.

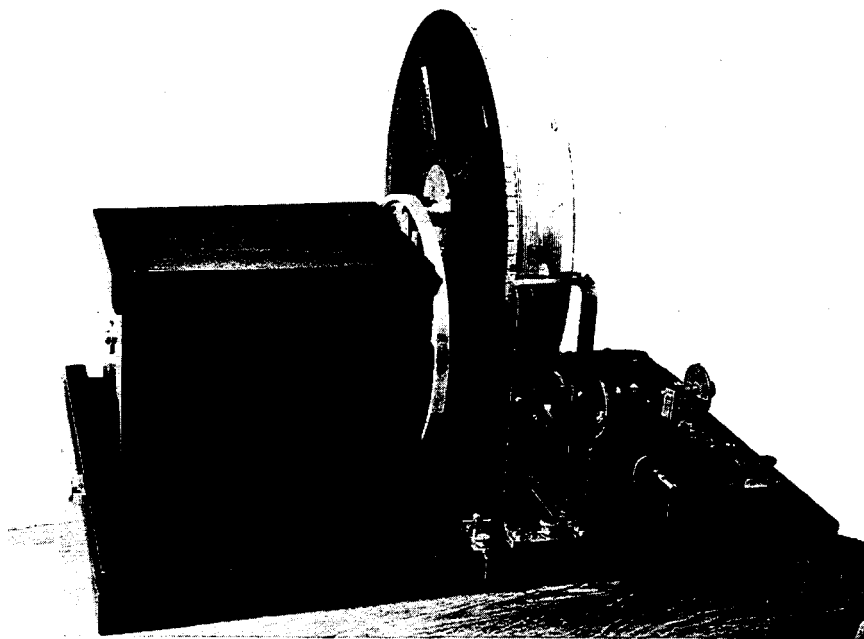

Fig. 4. The first polarograph.

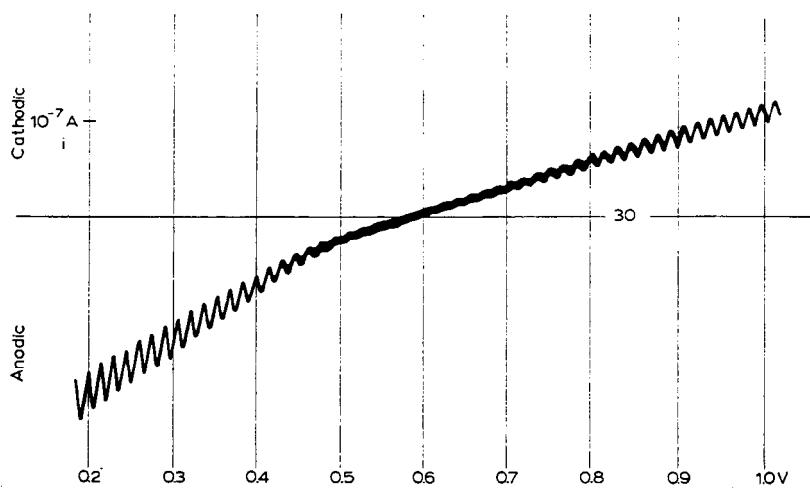

Fig. 5. Capacity current in 0.1 M KCl freed from air.

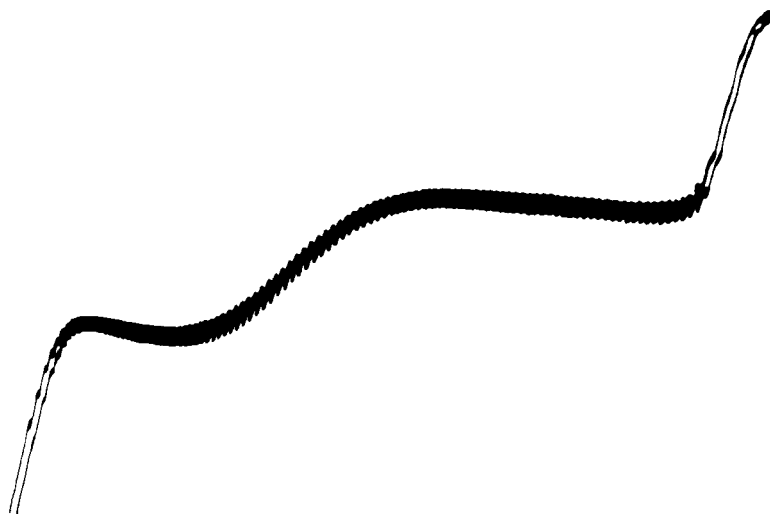

Fig. 6. Diffusion current of oxygen reduction in 0.1 M KOH. Curve repeated to show the reproducibility.

slower process than diffusion furnishes the depolarizer. In the case of formaldehyde the molecules of methylene-glycol $\text{H}_2\text{C}(\text{OH})_2$ ⁷ have to be dehydrated to form the actual depolarizer which is H_2CO . The current is given by the rate of the dehydration, which of course depends on pH. Such currents are termed "kinetic" and bring the possibility to measure the rates of fast chemical reactions. Wiesner *et al.*⁸ obtained from the currents due to glucose the kinetic constants of mutarotation and calculated the amount of the free aldehyde in 0.655 M glucose at 25°C as 0.0030%. From the ratios of the two waves which appear in the reduction of a reducible acid, we are able to calculate the very high rates of the recombination of the ions with the kinetic constants of the order 10^7 to 10^{11} (Fig. 11).

Contrary to the kinetic currents very much higher are the polarographic currents due to catalytic processes in the evolution of hydrogen, especially those due to SH groups. For example, cystine and proteins in NH_3 buffers containing cobalt ions give a 500 to 700 times higher "catalytic" wave as cystine without the catalyst. Of these reactions the most noteworthy is the serological reaction of Brdicka⁹ (Fig. 12), to which many publications relate. This is characterized by the "protein double wave" (Fig. 13) which has been found to depend on the pathological state of the patient. All inflammations cause an increase of the protein wave. In non-feverish state it is cancer which is invariably manifested by an elevated protein wave. After the removal of



Fig. 7. Constancy of the half-wave potential in solution of various concentrations of CdCl_2 .

the cancerous centre, the reaction becomes normal; metastases elevate it. It has been ascertained that the proteins responsible for the cancer reaction are mucoproteins, belonging to the γ -2-globulins. Electrophoresis shows that the mucoproteins are akin to the serum component MP-2. On the other hand, liver diseases lower the protein wave, so that in liver troubles the polarographic test is specific.

Another type of polarographic current-voltage curves, closely connected with Kučera's anomalous maximum on the electrocapillary curve, are sharp maxima of current, which at a certain voltage fall to the limiting diffusion current¹⁰ (Fig. 14). An inspection of the dropping electrode through the microscope reveals vehement streaming of the electrolyte along the lines of force to the electrode. Such maxima are very easily suppressed by slight traces of adsorbable matter, like fatty acids, dye-stuffs (Fig. 15), gelatin and other colloids, and in this way indicate very sensitively the degree of purity of solutions. The practical applications of the phenomenon of maxima are manifold. They are termed maxima of the 1st order when formed in dilute electrolytes (Figs. 14, 15). In concentrated solutions there appear rounded

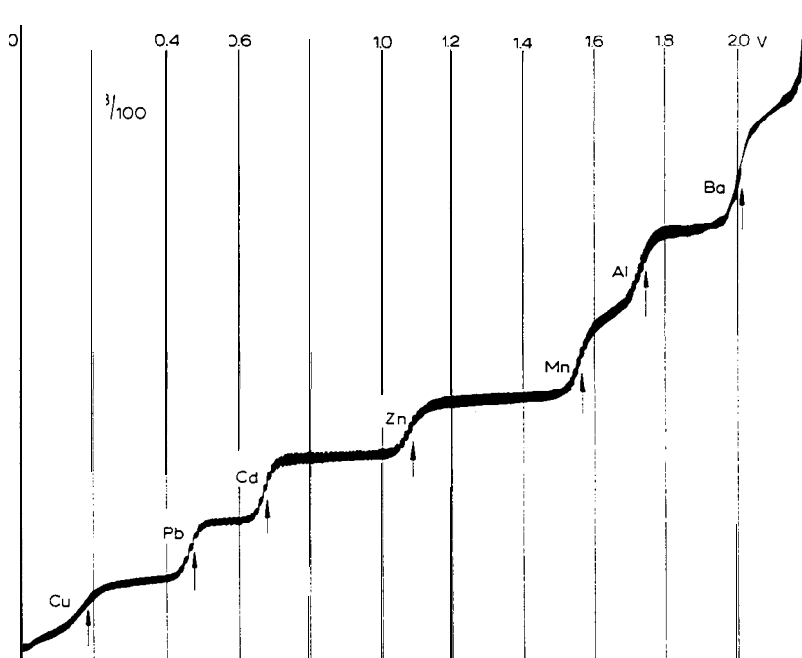

Fig. 8. Polarographic spectrum showing seven cations in the solution.

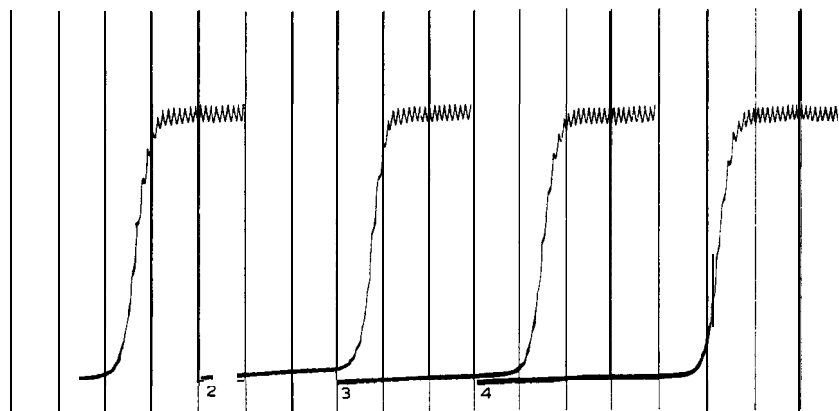

Fig. 9. Shift of the reduction wave of Pb^{2+} ions due to increasing concentration of NaOH. Concentration of lead ions $5 \cdot 10^{-4} \text{ M}$, concentration of NaOH (1 and 2) $1.2 \cdot 10^{-3} \text{ M}$; (3) 0.1 M, (4) 1 M. Anode potential -0.28 V from S.C.E.

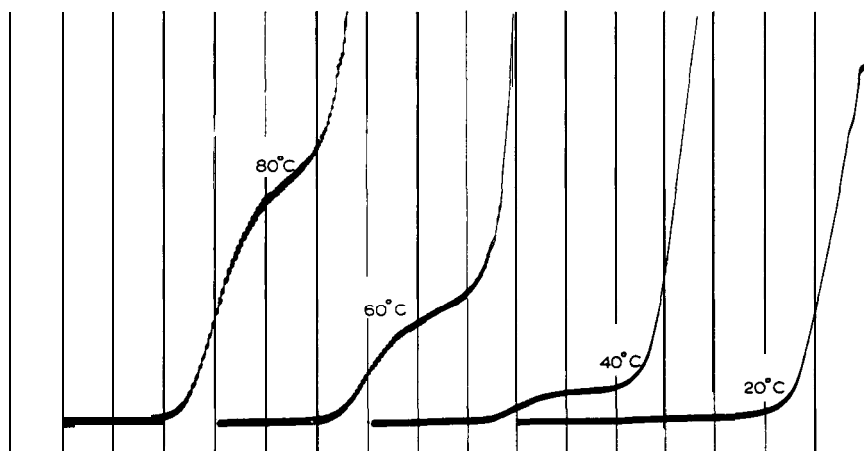

Fig. 10. Kinetic currents of glucose at various temperatures.

maxima of the 2nd order, due to the adhesion of the solution to the moving mercury surface at high rates of flow; they are also suppressed by colloids like gelatin (Fig. 16).

I have only referred to polarography of aqueous solutions. However, similar types of curves and electrode reactions may be followed in many nonaqueous conducting solutions, e.g. in acetonitrile, dioxane, alcohols, glacial acetic acid, sulphuric acid, liquid ammonia, and fused salts. In all of them *Ilkovič's* law has been found to hold good at all temperatures.

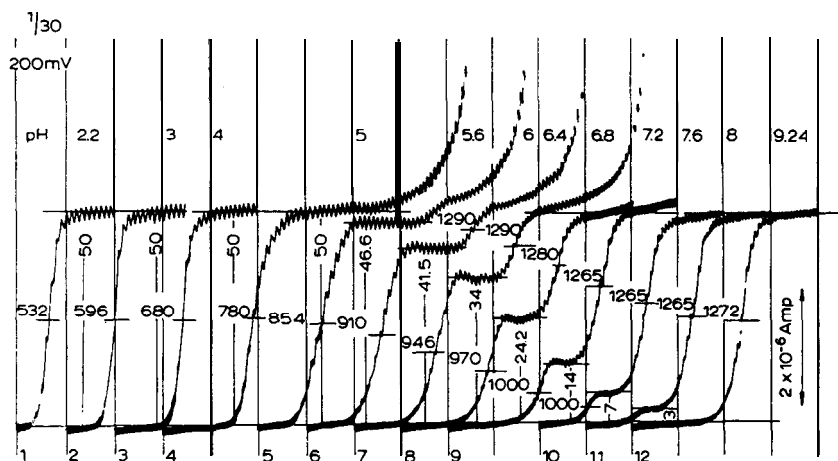

Fig. 11. Polarographic reduction waves of phenylglyoxylic acid in buffer solutions of various pH.

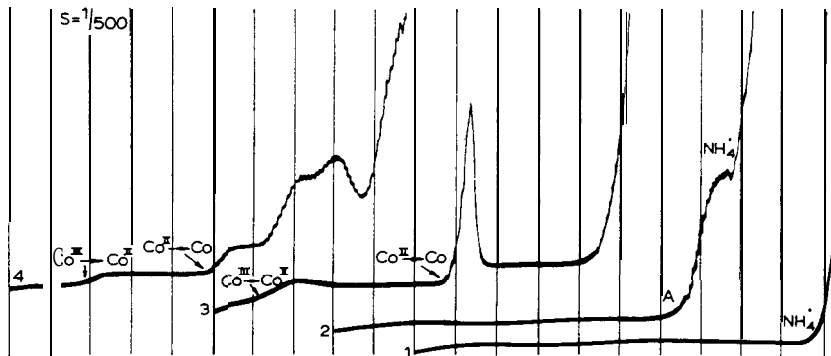

Fig. 12. The effect of proteins in ammoniacal solutions without and with the presence of cobalt.

Curve 1: $0.1 N NH_4Cl, 0.1 N NH_3$ in human serum diluted 1:400. Curve 2: in solution. Curve 3: $0.001 M Co(NH_3)_6Cl_3, 0.1 N NH_4Cl$ in human serum diluted 1:400. Curve 4: in solution. Curves start at 0 V, abscissae 200 mV.

The current-voltage curves are reproducible enough to yield with sufficient exactness even their derivative curve $di/dE - E$ (Fig. 17). Since at the half-wave potential the ordinary primitive curve has an inflexion, the derivative curve shows there a maximum, the height of which is proportional to the concentration of the depolarizer. The potential of the maximum indicates the quality. There are several methods to obtain the derivative curve automatically.

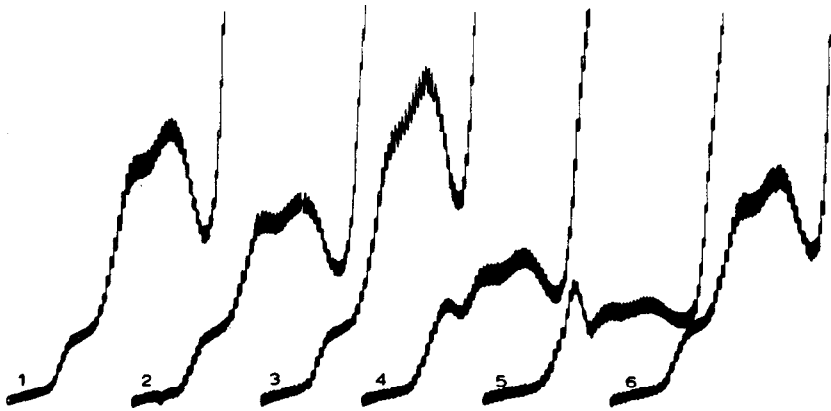

Fig. 13. Brdiika's test with blood sera of various pathological states. (1) status febrilis; (2) tumor hepatis susp.; (3) ca ventriculi susp.; (4) normal serum; (5) cirrhosis hepatis; (6) arteriosclerosis.

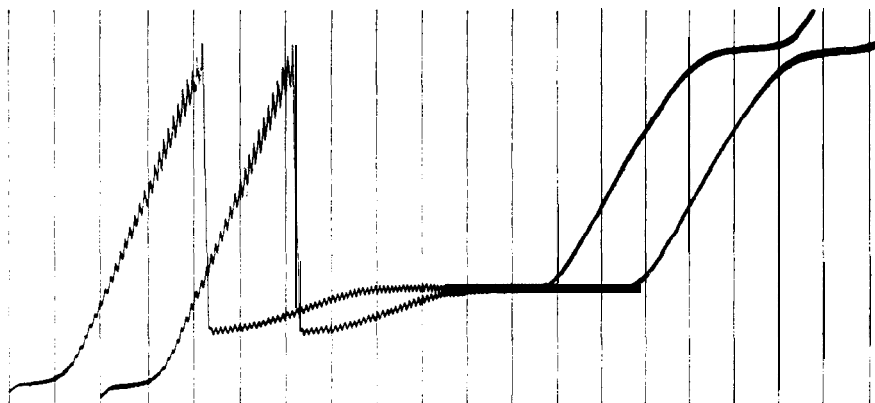

Fig. 14. Maximum of the first order on the wave of oxygen in 0.001 M KCl.

The sensitivity of the polarographic method is high, showing depolarizers in a $5 \cdot 10^{-6} M$ concentration even in 0.1 cm^3 , in a special vessel even in 0.005 m^3 , in which $5 \cdot 10^{-11} \text{ g}$ of a depolarizer may be ascertained (Fig. 18b). The most sensitive test is that of ruthenium which is shown in a $5 \cdot 10^{-10} M$ concentration¹². With the Barker's "square wave polarograph"¹³ where the charging current is practically eliminated, and the electrolytic one strongly amplified, curves are obtained of a derivative character, which show 10^{-8} mol per litre (Fig. 19).

Most sensitive is polarography combined with the measurements of radio-

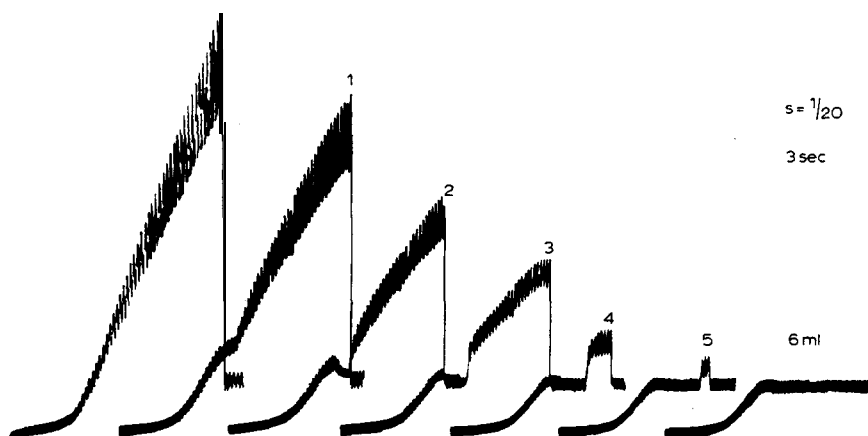

Fig. 15. Suppression of the maximum by a solution of fuchsin acid salt. ($10^{-3} M$ fuchsin acid salt added to 50 ml 0.001 M KCl)

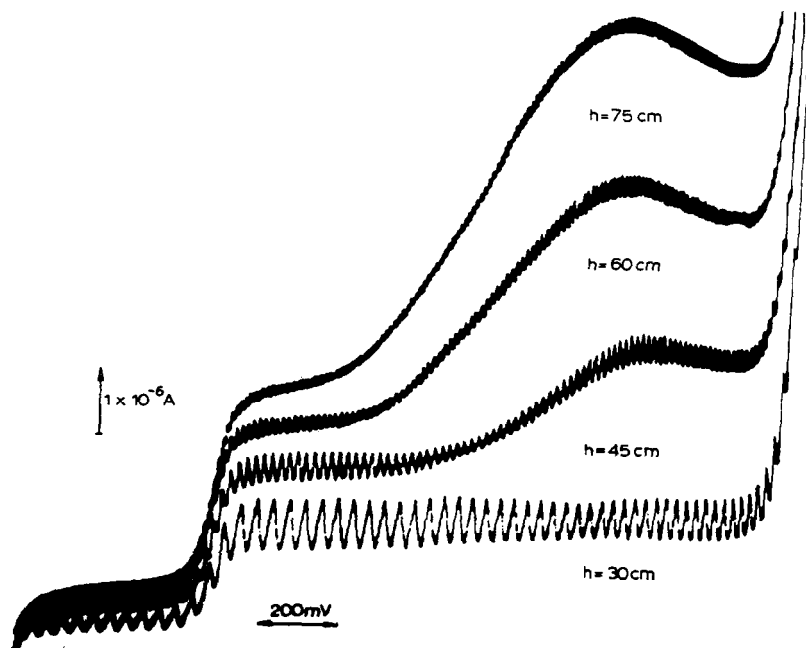

Fig. 16. Maximum of the second order due to CdCl₂ in 4.5 M KCl. Influence of increasing the rate of flow of mercury (h , height of the mercury reservoir). Conditions: $\times 10^{-3}$ N CdCl₂; N₂ atm.; 18°C.

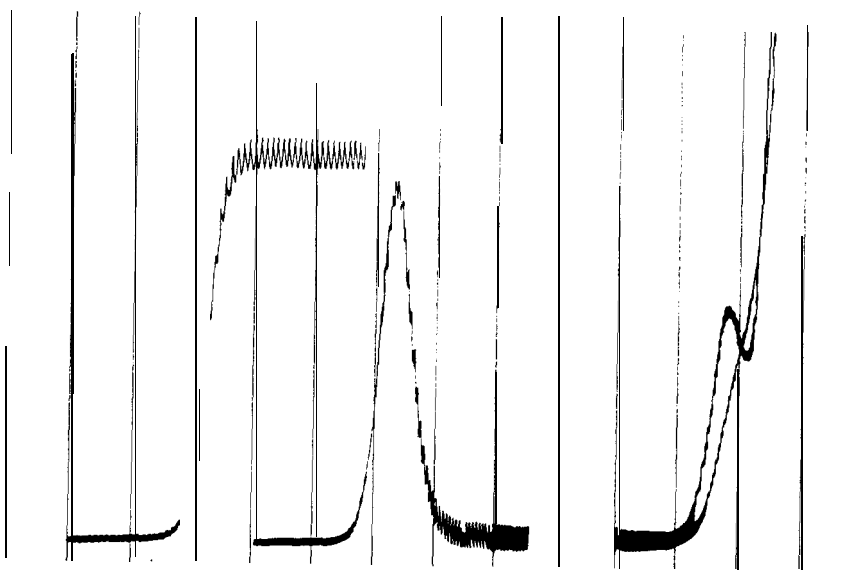

Fig. 17. Primitive and derivative polarographic curves: (left) 0.001 M CdCl₂ in ammonia buffer solution, 0.1 N NH₃ in NH₄Cl; (right) 0.001 M CdCl₂ in 0.1 N LiOH.

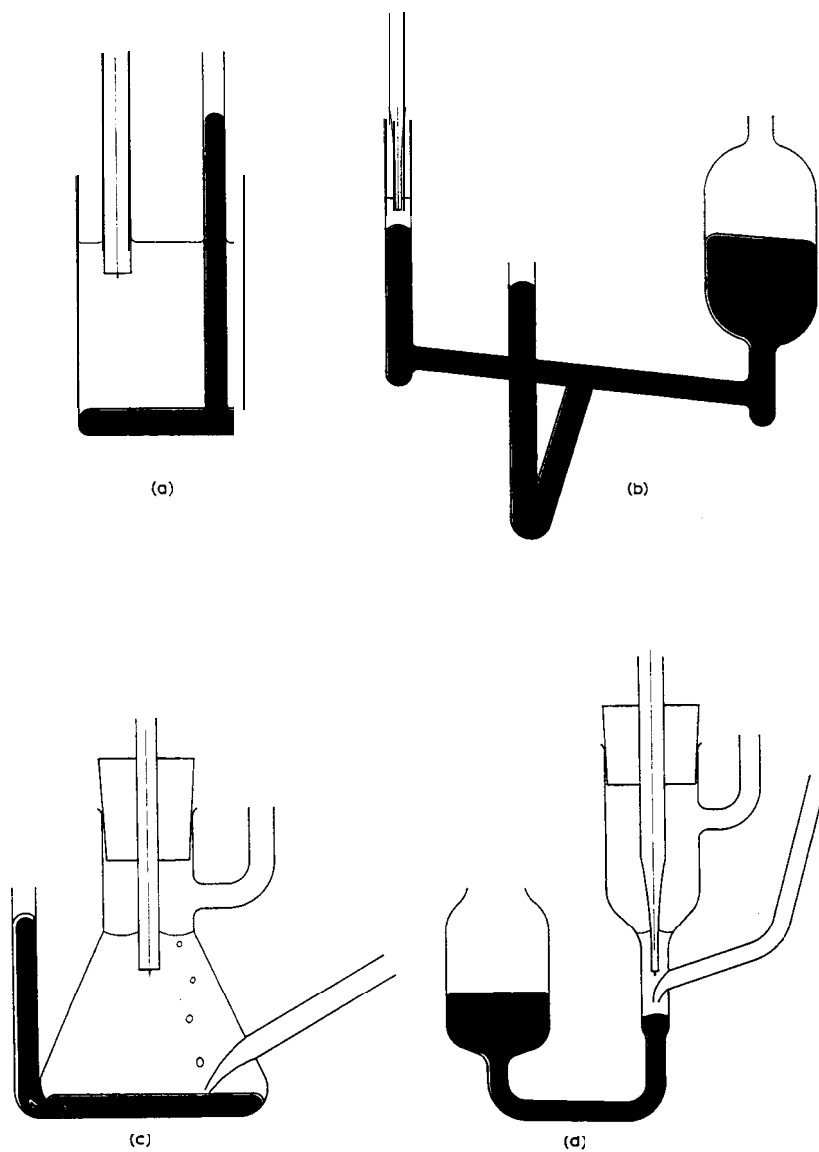

Fig. 18. Polarographic cells for standard- (a,c) and micro- (b,d) analysis.

activity (Fig. 20)¹⁴. The method consists in measuring the activity of the β and γ radiation of mercury drops on which the radioactive metal has been deposited. Isotopes, of course, cannot be distinguished, but e.g. from a mixture of radioactive zirconium 95 and its daughter substance, niobium 95, zirconium 95 can be separated, because it is deposited at the electrode,

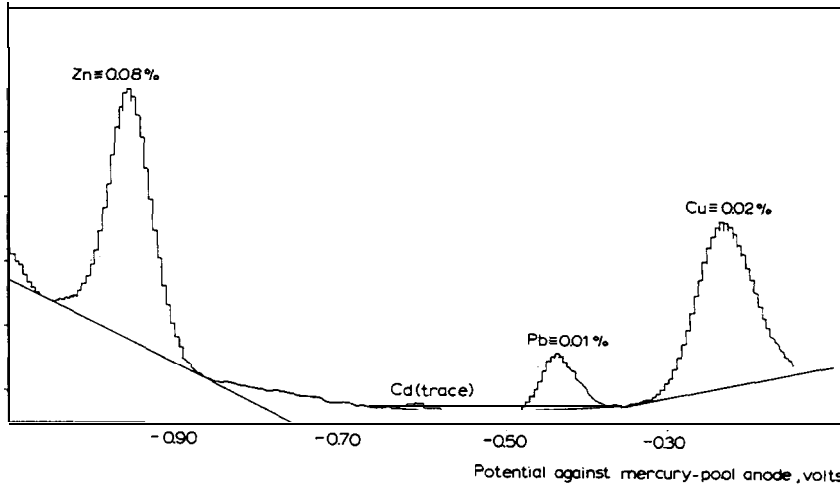

Fig. 19. Square wave polarogram of an analysis of aluminium alloy; 200 mg of sample in 100 ml of 1 M KCl.

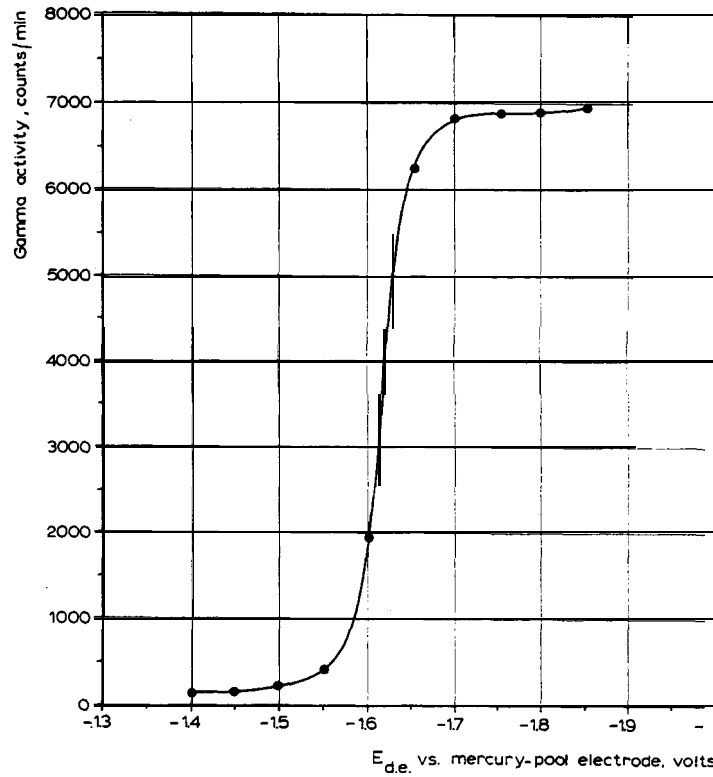

Fig. 20. Plotting of radioactivity of mercury drops against the applied potential.

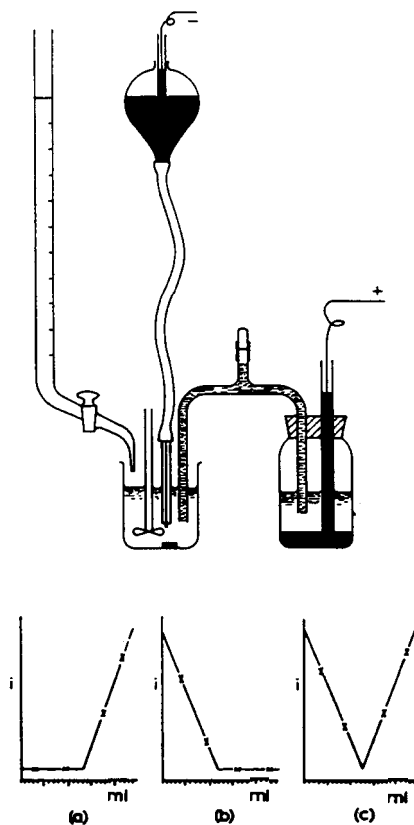

Fig. 21. Limiting current titrations (arrangement and diagrams).

whereas niobium remains in solution. This radioactive technique promises wide applications not only by enabling one to carry out quick, accurate analyses and separations of radionuclides, but also to learn basic electrochemistry of very dilute solutions and electrode reactions. The sensitivity is that of radioactive methods.

All the above-mentioned polarographic methods are used for analytical determinations, qualitative and quantitative, in microdoses as well as macrodoses of inorganic or organic depolarizers. If the substance to be determined is not a depolarizer, it may be chemically converted into a depolarizer and so determined. For example benzene is no depolarizer, its traces in air are noxious and its microdetermination wanted. The smallest traces of benzene are easily converted by nitration into nitrobenzene and after alkalization exactly determined in expired air, in blood or urine.

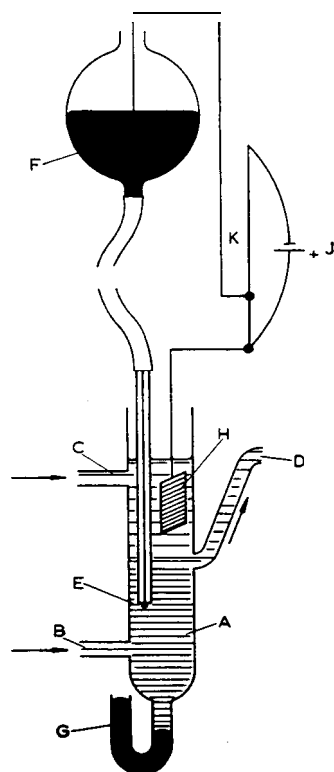

Fig. 22. Scheme of a continuous polarographic analyzer. (E) indicating electrode; (H) redox electrode of constant potential; (A) solution to be analysed; (B) inlet; (C) redox mixture inlet; (D) outlet.

A new trend in volumetric analysis has been introduced by polarographic titrations¹⁵ (1926) later called "polarometric" by Majer (1936) and "amperometric" by Kolthoff (1939), which use the limiting current to indicate the end-point. The indicating electrode may be not only the dropping electrode, but also a rotating or vibrating solid metallic electrode. The accuracy of the polarographic titration here reaches 0.3 %. For the titration graph suffice two readings of the current before and two after the equivalence point. The method does not want a polarograph; a potentiometer and a galvanometer of less sensitivity suffice (Fig. 21).

Based on the polarographic experience there are constructed special continuous polarographic analysers¹⁶ following for many weeks without interruption the content of solutions flowing through the cell (Fig. 22). They are used in industry for the automatic control and regulation of technical pro-

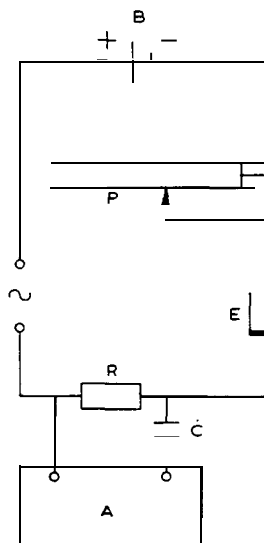

Fig. 23. Circuit of Breyer's alternating-current polarography. (A) voltmeter; (B) accumulator; (C) condenser; (E) dropping mercury cell; (P) potentiometer; (R) resistance; (V) alternating voltage.

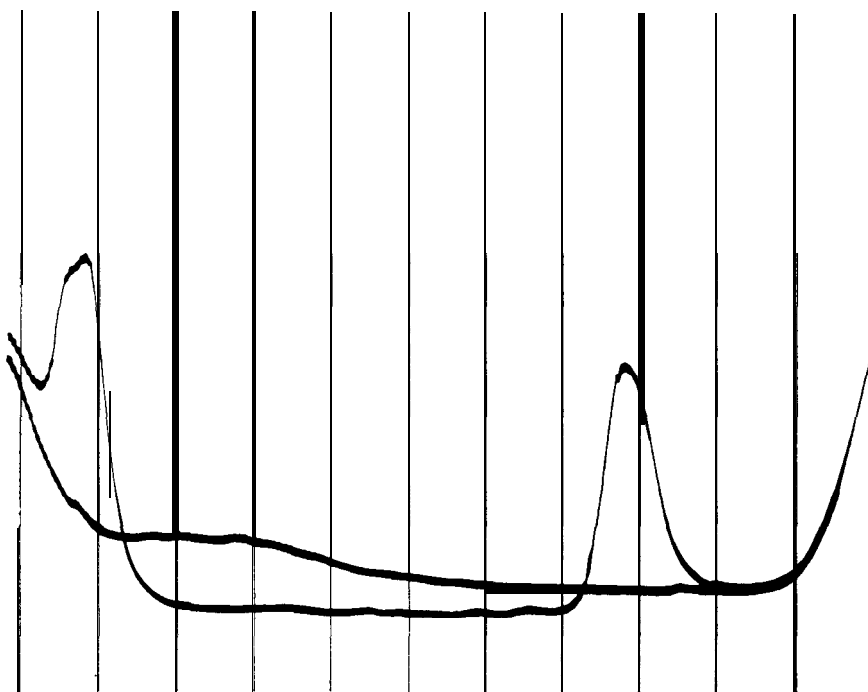

Fig. 24. Tensammetric maxima due to adsorption and desorption of cyclohexanol in acetate buffer solution. (*Upper curve* : pure solution).

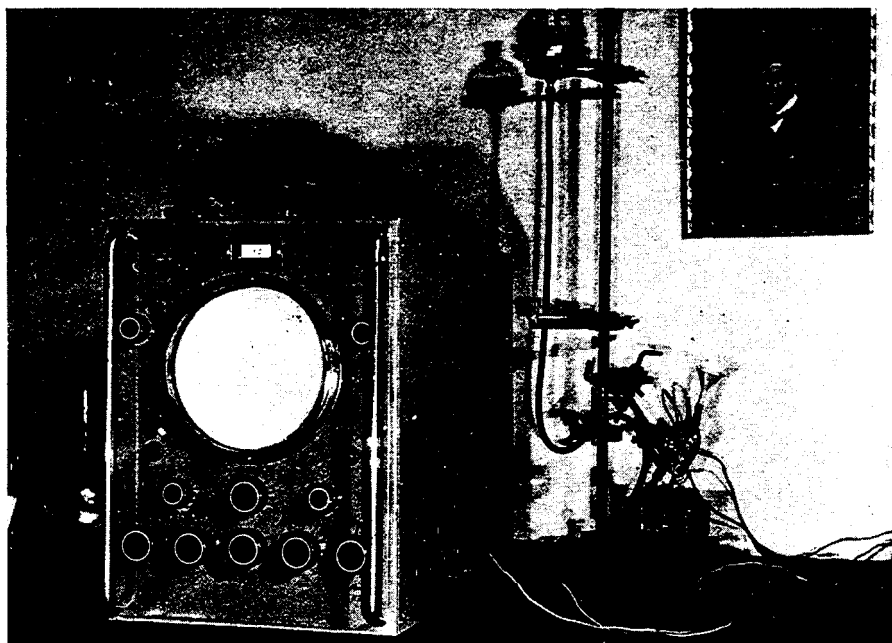

Fig. 25. Oscilloscope for polarographic analysis.

cesses, and for recording the presence of noxious gases in the atmosphere, like SO_2 , HCN , CO , etc.

Breyer and his co-workers¹⁷ introduced in 1944 the "tensammetric" method which uses the dropping mercury arrangement by applying a slowly increasing voltage with superposed alternating voltage (Fig. 23) of some 10 to 30 mV and 50 Hz frequency. The alternating current which passes through the polarographic cell is measured, and the current-voltage curve recorded. The method resembles the derivative method inasmuch as it gives peaks at the half-wave potentials of reversible depolarizers, but is very sensitive to adsorbable substances which change the surface tension of mercury electrode (Fig. 25). Hence the name "tensammetry". The changes of the capacity due to adsorption produce on the current-voltage curves peaks often 100 times higher than is the normal height of the wave of the organic depolarizers. The chief advantage of Breyer's tensammetric method is that it can determine with high sensitivity many organic substances which are polarographically inactive, provided they are surface active.

A great field, opened to polarography since 1938, is "oscillographic polarog-

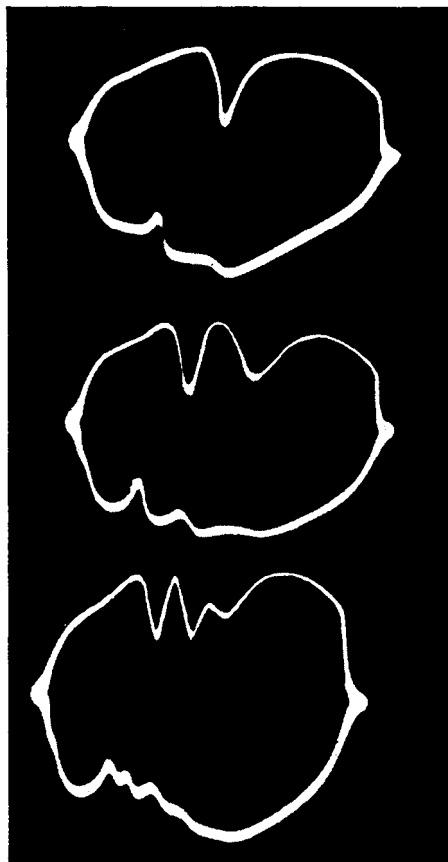

Fig. 26. Oscillographic diagram $dE/dt = f(E)$ of *o*-nitrophenol (*above*),
m-nitrophenol (*middle*)
and mixture of *o*- and *m*-nitrophenols (*below*).

raphy¹⁸ which substitutes the cathode-ray, oscillograph for the galvanometer and voltmeter (Fig. 26). This brings the velocity of recording a polarographic curve to 1/50 second with about the same accuracy of analytical determinations as in classical polarography (Fig. 27).

We meet often with the opinion that polarography did not bring anything new into chemistry except an improvement of analytical methods. That is decidedly not so, since in the study of reductions or oxidations many otherwise inaccessible physico-chemical constants are determinable. Polarography helps the investigation of chemical structure of organic and lately

even inorganic compounds. Striking are the results arrived at by polarographic studies of complexes of Co, Ni, Fe, Cr, the current-voltage curves of which disclose strange valencies. Vlček proved, for example, that cobalt in dipyriddy complexes is reduced¹⁹ from Co^{III} to Co^{II} , and Co^{II} to Co^{I} , and basing on these studies he succeeded in preparing crystalline monovalent

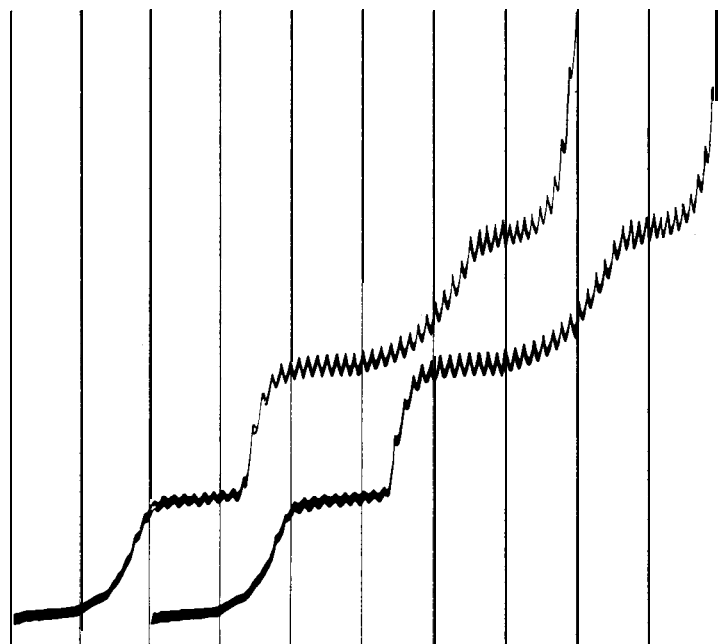

Fig. 27. Three-stage reduction of the chromic tripyridyl complex. Each step corresponds to the uptake of one electron.

$\text{Co}(\text{dipyridyl})_2^{\text{I}}$ complex. He also proved from polarographic curves the complex compounds of zero-valent Ni, Co, and in the carbonyles negatively divalent Fe and Co. The Cr tripyridyl complex may be successively reduced to Cr^{II} , Cr^{I} and Cr^{0} showing on the polarogram three equal steps (Fig. 27). So far it is the only instance in electrochemistry, in which a trivalent cation can acquire three times one electron in succession.

Although the analytical application of polarography is highly advanced at present, the field of its utilization in basic chemical problems begins to open.

1. J. Heyrovský and M. Shikata, *Rec. Trav. Chem.*, 44 (1925) 496.
2. D. Ilkovič, *Collection Czechoslov. Chem. Commun.*, 6 (1934) 498; *J. Chem. Phys.*, 35 (1938) 129.
3. J. Koutecký, *Czechoslov. J. Phys.*, 2 (1953) 50.
4. J. Heyrovský and D. Ilkoviz, *Collection Czechoslov. Chem. Commun.*, 7 (1935) 198.
5. J. Heyrovský, *Trans. Faraday Soc.*, 19 (1924) 692.
J. Koryta, *Chem. Tech. Berlin*, 7 (1955) 464.
6. K. Wiesner, *Z. Elektrochem.*, 49 (1943) 164.
7. R. Brdivda, *Collection Czechoslov. Chem. Commun.*, 20 (1955) 387.
8. J. M. Los, L. B. Simpson, and K. Wiesner, *J. Am. Chem. Soc.*, 78 (1956) 1564.
9. R. Brdička, *Collection Czechoslov. Chem. Commun.*, 5 (1933) 112; *Z. Phys. Chem. Leipzig, Sonderheft, Juli 1958*, 165.
10. M. v. Stackelberg, *Fortschr. Chem. Forsch.*, 2 (1951) 229.
J. Heyrovsky, *Z. Phys. Chem. Leipzig, Sonderheft, Juli 1958*, 7.
11. J. Vogel and J. Riha, *J. Chem. Phys.*, 47 (1950) 5.
12. M. A. El Guebely, *J. Chem. Phys.*, 53 (1956) 753.
13. G. C. Barker and I. L. Jenkins, *Analyst*, 77 (1952) 685.
14. D. L. Love, *Anal. Chem. Acta*, 18 (1958) 72.
15. J. Heyrovsky and S. Berezický, *Collection Czechoslov. Chem. Commun.*, 1 (1929) 19.
V. Majer, *Z. Elektrochem.*, 42 (1936) 123.
I. M. Kolthoff and Y. D. Pan, *J. Am. Chem. Soc.*, 61 (1939) 3402.
16. J. A. V. Novak, *Acta Chem. Acad. Sci Hung.*, 9 (1956) 37.
17. B. Breyer, F. Gutmann, and H. H. Bauer, *Österr. Chemiker Ztg.*, 57 (1956) 67.
18. J. W. Loveland, and P. J. Elving, *Chem. Revs.*, 51 (1952) 67.
J. Heyrovský and R. Kalvoda, *Oszillographische Polarographie*, Akademie-Verlag, Berlin, 1959.
19. A. A. Vlček, *Nature*, 177 (1956) 1043; 180 (1957) 753.