

# MOLECULAR DYNAMICS OF ELEMENTARY CHEMICAL REACTIONS

Nobel Lecture. 8 December 1986

by

DUDLEY R. HERSCHBACH

Department of Chemistry, Harvard University, Cambridge,  
Massachusetts 02138, U.S.A.

The vast field of Chemical Kinetics embraces three distinct levels of understanding or abstraction [1]. The broadest level is qualitative description. Here the emphasis is on *substances*: what products are obtained from what reagents under what conditions. The information gathered is encyclopedic, but quite feeble in predictive power. This is because the overall observed transformation in most reactions comprises a more or less complex sequence or network of elementary steps.

At the next level, the aim is to identify the distinct *elementary steps* and to determine quantitatively the rate factors of the Arrhenius equation,  $k = A \exp(-E_a/RT)$ , a remarkably durable formula now nearly a century old! Some steps involve intermediate species that do not appear among the final products; whenever possible, these intermediates are also characterized by structural, spectral, and thermodynamic properties. Over about the past 70 years, immense effort has been devoted to compiling such quantitative data. It is of great practical value because predictions can be made for many reaction systems, on the usually reliable assumption that the rate parameters for each indivisible elementary step can be carried over from one system to another.

As well as mapping the cooperation and competition among elementary processes, kinetic studies at this level also gave rise to many key chemical ideas. These include such concepts as chain reactions carried by free radical intermediates, collisional energy transfer, and the time-lag for energy flow within an excited molecule. Most fundamental was the idea introduced by Henry Eyring and Michael Polanyi of a transition-state on a potential energy surface. This has guided qualitative reasoning about molecular mechanisms, and when augmented by resourceful semitheoretical approximations for potential parameters has enabled limited but useful estimates of rate factors. However, these valuable insights were won despite frustrating handicaps. The basic experimental variables of concentration and temperature are not incisive enough to allow further progress. Postulated elementary steps or intermediates often prove incomplete or illusory. The observable rate factors, which represent averages over myriad random collisions, are too remote from the molecular interactions.

## Emergence of Chemical Dynamics

Over the past 30 years a new level has been attained by study of the intimate *molecular dynamics* of individual reactive collisions. One of the chief experimental approaches is molecular beam scattering. This involves forming the reagent molecules into two collimated beams, each so dilute that collisions within them are negligible. The two beams intersect in a vacuum and the direction and velocity of the product molecules emitted from the collision zone are measured. A host of reactions can now be studied readily in this way, by virtue of an extremely sensitive mass spectrometric detector and the use of supersonic nozzles which generate beams with greatly enhanced intensity and with collision energies much higher than provided by ordinary thermal sources. The coupling of spectroscopic techniques with molecular beams has provided further advances in selectivity and sensitivity, particularly by use of intense laser light sources.

The reaction properties now accessible include the disposal of energy among translation, rotation, and vibration of the product molecules; angles of product emission; angular momentum and its orientation in space; and variation of reaction yield and other attributes with impact energy, closeness of collision, rotational orientation or vibrational excitation of the target molecule. From the earliest stages these experiments have stimulated and responded to a vigorous outburst of theoretical developments. Especially helpful are computer simulations in which dynamical properties are predicted for various postulated forces by Monte Carlo sampling of huge numbers of calculated collisions trajectories. Both the laboratory experiments and computer simulations have prompted a variety of insightful mechanical models as well as very useful diagnostic procedures based on information theory. *Ab initio* electronic structure calculations have also begun to contribute significantly to the exploration of reaction dynamics, although (except for  $H + H_2$ ) satisfying overall accuracy has yet to be achieved for potential energy surfaces.

As urged by my students, on this occasion I want both to view our still youthful field of research from a wider perspective and to recount some favorite, instructive episodes from its infancy. I will also briefly discuss several prototype reactions that have served to develop heuristic models and to reveal how electronic structure governs the reaction dynamics. More technical and systematic surveys are abundant [2]. Particularly recommended are recent books by Bernstein and by Levine and Bernstein [3]. The latter, about to appear in its second edition, contains references to 500 review articles in the field of molecular reaction dynamics. Nobody has tried recently to count the research papers in this prolific field; these probably now exceed 5000. This does not include kindred developments in the study of molecular dynamics in solution or the solid phase.

The emergence of chemical dynamics captivated many enterprising scientists and imbued them with a sense of historical imperative. Figure 1 indicates this in the wider context of physical chemistry. The subject began with thermochemistry, still its foundation. The thermochemical era can be considered to reach a pinnacle in 1923, with the publication of the classic text by Lewis and

Randall. This was shortly before the discovery of quantum mechanics ushered in the new structural era (and spawned chemical physics). In turn, the grand pursuit of molecular structure and spectra reached a twin pinnacle in 1951 and 1953 with the monumental discoveries of the alpha-helix by Pauling and the DNA double-helix by Watson and Crick. This was shortly before the early molecular beam and infrared chemiluminescence experiments appeared as har-

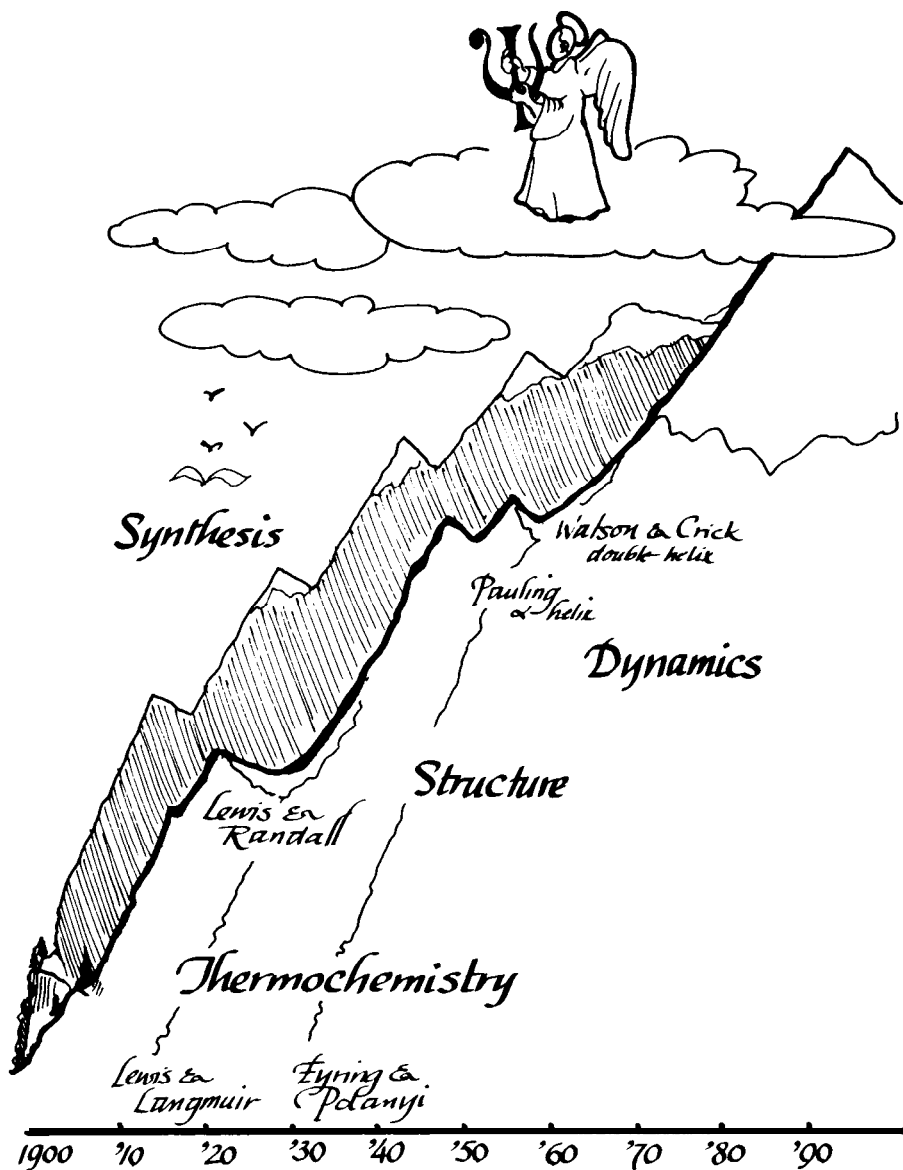

Fig. 1. Historical perspective. Ascending mountains represent three eras, since thermochemistry was prerequisite for the *structure* era and both underlie the *dynamics* era. All three connect to a vast range representing *synthetic* chemistry, which draws closest to dynamics as both disappear heavenwards into clouds symbolizing the ultimate triumph of *ab initio* quantum chemistry.

bingers of the dynamics era. It is striking that the prequantum models of Lewis and Langmuir, still valued today, came well before the onset of the structural era. Likewise, the potential surface and transition-state concepts of Eyring and Polanyi anticipated the dynamics era.

Not evident in Fig. 1, and in contrast to the scientific continuity, are cultural chasms between the eras. Linus Pauling once told me of the gulf his students encountered in the late 1920's when, as candidates for an academic position, they presented seminars describing molecular structures they had determined by electron diffraction. All the faculty in the audience had done their Ph.D.'s in thermochemistry, and so imbibed a tradition which emphasized that it did not need to postulate the existence of molecules! Worse, interpretation of the diffraction rings then relied entirely on the so-called "visual method". A densitometer tracing showed only monotonically decreasing intensity curves; the rings could only be seen because the human eye can detect slight changes in intensity. The molecular structures obtained thus depended on an "optical illusion," incomprehensible and reprehensible to many professors of thermodynamics. Forty years later, my own students encountered a similar gulf when presenting seminars describing our early crude molecular beam reactive scattering studies. Almost all the incumbent faculty then had done their Ph.D.'s in structure or spectroscopy. They were dubious about work that depended on drawing velocity vector diagrams to interpret bumps on scattering curves.

### **Molecular Beams Before Chemical Dynamics**

The first molecular beam experiments were carried out 75 years ago, immediately after the invention of the high speed vacuum pump had made it possible to form directed "rays" of neutral molecules at sufficiently low pressures to prevent their disruption by collisions with background gas. Figure 2 indicates the historical progression. Systematic research began with Otto Stern, who developed many aspects of beam techniques. He had retired and was living in Berkeley when I arrived there in 1959. Occasionally Stern attended seminars, and I had the opportunity to hear from him several memorable stories about his work. Two of these are pertinent here.

In his first work, done at Frankfurt in 1919, Stern undertook to test the Maxwell-Boltzmann velocity distribution by analyzing the speeds of a silver atom beam with a rotating device. Gleeefully, he described how the money to build the apparatus was supplied by Max Born; the great theoretical physicist was renowned as a public speaker and gave a special lecture series to raise the funds. Stern found that his experimental results were in approximate agreement with the Maxwell-Boltzmann distribution, but deviated from it in a systematic way. He said [4]:

"After my paper was sent off, I received a letter pointing out that I had overlooked an extra factor of  $v$  (the velocity) which enters because the detected atoms must pass through a slit. When this factor was inserted, the agreement became quantitative. That letter came from Albert Einstein!"

The "extra factor" represents the Jacobian for the transformation from number

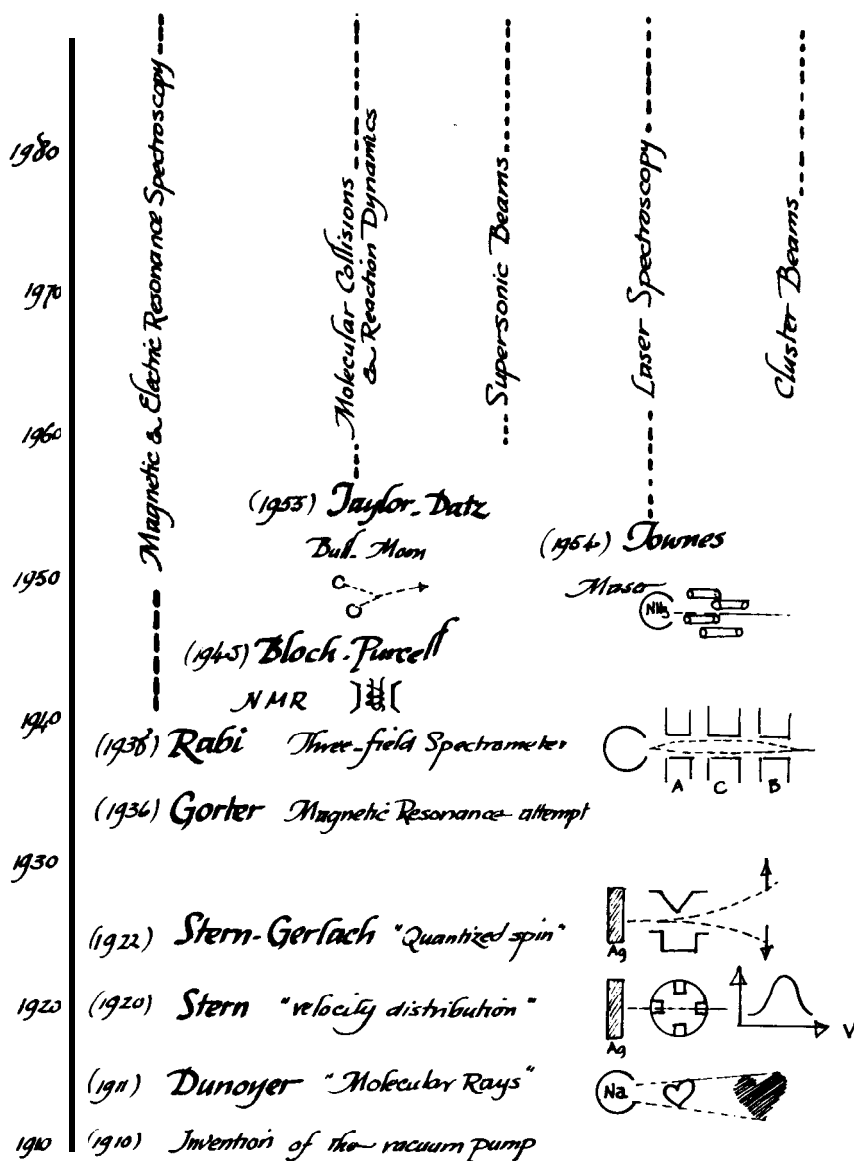

Fig. 2. Evolution of molecular beam and kindred methods.

density (atoms  $\text{cm}^{-3}$ ) to flux density (atoms  $\text{cm}^{-2}\text{sec}^{-1}$ ). That same factor and Jacobians for numerous other transformations often appear in chemical dynamics, so I've had reason to tell Stern's story to many bedeviled students. As noted below, some striking effects in molecular collisions are due entirely to a Jacobian factor.

The other favorite story concerns the celebrated Stern-Gerlach experiment, in which a beam of silver atoms was sent through an inhomogeneous magnetic field and discovered to split into two, thereby revealing the space-quantization of the electron spin. This is how Stern told the story [4]:

“The question whether a gas might be magnetically birefringent (in the words we used in those days) was raised at a seminar. The next morning I awoke early, too early to go to the lab. As it was too cold to get out of bed, I lay there thinking about the seminar question and had the idea for the experiment. When I got to the lab, I recruited Gerlach as a collaborator. He was a skilful experimentalist, while I was not. In fact, each part of the apparatus that I constructed had to be remade by Gerlach.”

“We were never able to get the apparatus to work before midnight. When finally all seemed to function properly, we had a strange experience. After venting to release the vacuum, Gerlach removed the detector flange. But he could see no trace of the silver atom beam and handed the flange to me. With Gerlach looking over my shoulder as I peered closely at the plate, we were surprised to see gradually emerge two distinct traces of the beam. Several times we repeated the experiment, with the same mysterious result. Finally we realized what it was. I was then the equivalent of an assistant professor. My salary was too low to afford good cigars, so I smoked bad cigars. These had a lot of sulfur in them, so my breath on the plate turned the silver into silver sulfide, which is jet black so easily visible. It was like developing a photographic film.”

Although I've rarely tried a cigar, our first reactive scattering work also benefited from lucky contamination of the detector, as described later.

Soon Stern could afford good cigars, as he was appointed professor of physical chemistry at Hamburg. His Institute there conducted a series of remarkable molecular beam studies, including invention of the surface ionization that was to be so vital in the “alkali age” of chemical dynamics. This detector, derived from Langmuir's studies of surface ionization, has since been used in thousands of experiments. It consists simply of a heated filament of a metal such as tungsten and will ionize with nearly 100 % efficiency materials having ionization potentials lower than about 4 or 5 volts, such as alkali atoms. Stern had to abandon his splendid work at Hamburg in 1933 when Hitler took office.

Other epochal molecular beam contributions to physics came from Isidor Rabi. He had also been educated as a chemist and worked with Stern as a postdoctoral fellow before joining the physics faculty at Columbia. In 1937 he invented his magnetic resonance method. This followed a seminar by Gorter from Leiden describing his failed attempt to detect nuclear magnetic resonance in a crystal. It was then not obvious that the tiny nucleus, with dimensions of the order  $10^{-13}$  cm, would interact appreciably with the external atomic electron distribution, with dimensions of the order  $10^{-8}$  cm. If not, the different nuclear spin orientations (favorable: “up” or unfavorable: “down”) would remain equally probable even when subjected to an external magnetic field. There would then be no net absorption of radiofrequency radiation in the magnetic resonance experiment. Spin flips induced by the radiation are equally likely up or down, so net absorption cannot occur unless interactions permit the spins to relax toward thermal equilibrium where more will be up than down.

Rabi immediately realized how to exploit beams to escape this constraint. He

introduced two opposing Stern-Gerlach fields. A beam traversing the first field (denoted A) is split into its nuclear spin components, but on passing through the second field (denoted B) these are recombined. Between these fields, which act like diverging and converging lenses, Rabi introduced a third field (the C-field). This was homogeneous and so had no lens action, but it served the role of Gorter's field in defining "up" and "down". Since there are no collisions in the beam, there is no means to relax the spin component populations. But now none is needed. Radiofrequency radiation in the C-field region will at resonance flip equal numbers of spins up or down; but now any spin changing its orientation after the A-field will not be refocussed in the B-held. In this ingenious way, Rabi could detect which frequencies produced resonances. He thus created a versatile new spectroscopy with extremely high resolving power. It has provided a wealth of information about nuclear structure. An analogous electric resonance spectroscopy operates with rotational states of polar molecules. This has likewise been very fruitful for molecular structure. It has also been used to fully analyze the quantum states of products in some reactive scattering experiments.

Shortly before inventing his resonance spectroscopy, Rabi undertook some simple elastic scattering studies by observing the attenuation of an alkali atom beam sent through a gas-filled chamber and detected on a surface ionization filament. If Gorter had not come by, perhaps Rabi would have continued on to develop reactive scattering. Another quirk of fate was only revealed in 1945, when nuclear magnetic resonance was successfully done in liquids and solids by Purcell at Harvard and Block at Stanford. Only then did it become clear that Gorter's original experiment would have worked if he had used a material with magnetic impurities which would have induced the necessary relaxation. Yet another epilogue, also of great portent, was the invention of the maser in 1955 by Townes at Columbia. In this device, the precursor of lasers, he sent a beam of ammonia molecules through an electric quadrupole focussing field which selected an energetically unfavorable state. When illuminated with microwave radiation, the molecule reverted to the energetically favorable state, emitting the excess energy as a photon. Thus was born molecular amplifiers and oscillators and the now vast industry of quantum electronics. The idea came to Townes on a sunny park bench, 35 years after Stern woke up early in his warm bed.

### **My first Encounters with Kinetics and Beams**

Within days of my arrival at college, I first learned something of the challenging field of chemical kinetics from my freshman advisor, Harold S. Johnston. He was then a young assistant professor at Stanford University, applying new methods of his own devising to measure rates of fast gas-phase reactions in regimes previously inaccessible. In the summer after my sophomore year, and again after my junior year, Hal hired me as a lab assistant for his research group. One project involved weeks of glassblowing, silver soldering, and plastering with great quantities of asbestos paste (now outlawed) to install a large volume reaction vessel that could be maintained at a high and uniform tem-

perature. I was greatly impressed with the care and attention to detail shown by Hal and his graduate students, and his emphasis on testing theory. He stressed that this could only be done with a reaction known to be an elementary step - and that we could never be entirely certain that all steps and intermediates had been correctly identified.

In my senior year, I took Hal's excellent course in chemical kinetics, and the following year a study of transition-state theory begun there became my master's thesis. In this, we calculated the Arrhenius A-factors for twelve well-characterized bimolecular reactions involving only 4 to 6 atoms. Necessary assumptions about the properties of the transition state were made uniform for the whole set and consistent with similar stable molecules. Internal rotations of the reaction complexes received special attention, thanks to the help of Kenneth Pitzer at Berkeley, who kindly showed me how to design a sensible approximation. Previous tests had been piecemeal and often capricious about internal rotations; Hal expected our test might prove embarrassing for the theory. In fact, the agreement with experiment was good. This persuaded Hal that the theory deserved further development; over the next decade he carried this out and produced an exemplary book. Although Hal's contagious enthusiasm had long since convinced me that I wanted to pursue kinetics, the thesis project made me decide to study first the dynamics of stable molecules. Thus I applied to the chemical physics program at Harvard in order to do Ph.D. research with E. Bright Wilson, Jr.

A few weeks before turning in the master's thesis, I first heard of molecular beams. In his course on statistical thermodynamics, Walter Meyerhof briefly described Stern's test of the Maxwell-Boltzmann velocity distribution. It was love at first sight. I remember a flush of excitement at the thought that this was the way to study elementary reactions, the unequivocal way to know a reaction is elementary and to study directly its properties. This was the spring of 1955. I did not imagine that 5 years later my own first beam apparatus would be nearly complete at Berkeley and I would have met Otto Stern himself.

On arrival at Harvard in the fall, I was delighted to discover that Norman Ramsey was offering a seminar course based on the proof sheets of his book on molecular beams. E. B. Wilson was giving a course using his just published book on molecular vibrations. Roy Glauber provided a rigorous treatment of electromagnetic theory, working through all the mathematical derivations in class with no notes at all. The dessert course of this remarkable academic menu was entitled "Chemical Physics", and given by the legendary Peter Debye, a visitor that year. His course had 40 or more auditors, but only 3 of us took it for credit and thus had individual oral exams with Debye. I still relish the memory of his lucid lectures and the twinkle in his eye as he so often began, "Let me tell you a story . . ." Early in Ramsey's course, he too discussed Stern's velocity analysis study and actually announced, in his booming voice: "This would be a wonderful way to do chemistry!" In the spring term I took among others Kenneth Bainbridge's course on nuclear physics to learn something about nuclear reactions; this was indeed to prove very useful later.

Even more exhilarating that year and thereafter was my experience in Bright



Wilson's research group. With microwave spectroscopy, he and his students were developing an elegant new way to study internal rotation by exploiting the tunnel effect. Typical systems had a methyl group attached to an asymmetric molecular frame. The torsion or internal rotation of the methyl group about its axis is hindered by a sinusoidal potential barrier with three equivalent minima. If the barrier is very high, then essentially there are only small torsional oscillations in three separate potential wells, and to good approximation the microwave spectrum is that of a rigid rotor molecule. If the barrier is low enough, however, tunneling between the well occurs and this causes the microwave rotational transitions to split into doublets. These splittings are very sensitive to the barrier height, so an approximate dynamical theory is adequate to extract an accurate value for the barrier. Since I already had seen how prevalent internal rotation is, not only in stable molecules but in transition-states for reaction, I was very excited about this new method. It was such a fresh and powerful approach that almost every day some member of the group had an unanticipated result to report. Because the microwave spectra display a forest of transitions, there was ample need to work out variations on the basic theme and satisfying opportunity for definitive tests.

Although this research was entirely different in character from molecular collisions, I learned invaluable lessons from it and from working with Bright and his extremely able group. A microwave spectroscopist simply must calculate as much as possible before plunging into the forest; for a molecular beamist, the need is less obvious but just as vital. Bright's high standards and absolute integrity had great impact on his students. Thus he put strong emphasis on analyzing and clearly stating what is well-established and what is really based on unproven assumptions. He also gave strong emphasis to blocking out the big questions and on coupling theoretical investigations with experiments.

Microwaves soon led to my first work with beams, in collaboration with an ebullient young instructor, Bill Klemperer. He had developed a technique for high temperature infrared spectroscopy and was using it to study alkali halides (later to become my favorite molecules). Bill invited me to help build a high temperature microwave spectrometer, again a project requiring much asbestos paste. One day Bill came in with a paper just published by Marple and Trischka reporting an electric resonance study of lithium chloride. They had used the venerable tungsten surface ionization filament as a detector. Depending on resonance field settings, the apparatus could resolve four vibrational states. However, the vibrational frequency derived from the relative intensities was much lower than Bill had measured in the infrared. We examined various possibilities and concluded that most likely was an increase in the efficiency of the surface reaction (dissociation of the salt molecule to ions) with vibrational excitation of the incident molecule [5]. This was near Christmas, 1956. Almost 15 years later, the vibrational excitation mechanism was confirmed and recently it has become a leading issue in surface chemistry.

We were eager to study the surface ionization process experimentally. Since an electric resonance apparatus was not available (at that time only 3 existed,

none closer than 300 miles of Cambridge), we could not study alkali halide molecules. Hence we decided to study ionization of alkali atoms as a function of the surface temperature. Ramsey kindly lent us one of his machines over Christmas vacation and we quickly obtained a hundred pages or so of data from which we derived residence times and heats of adsorption for atoms on tungsten and platinum surfaces. Then we discovered that very similar data existed in the Russian literature, so did not publish our results. However, this was a key episode for both Bill and me. He too fell in love with molecular beams, and immediately undertook to build an electric resonance apparatus. Bill and his students have since turned this into a cornucopia for molecular spectroscopy, unprecedented in resolution and chemical scope. Especially revealing have been their studies in recent years of molecules held together by weak van der Waals forces. This work is building an understanding of these ubiquitous forces which may help elucidate the specificity and selectivity of interactions in biomolecules.

In studying the literature on surface ionization, I was elated to discover [6] a paper by Taylor and Datz from Oak Ridge describing an actual crossed beam study of the reaction  $K + \text{HBr} \rightarrow \text{KBr} + \text{H}$ . Although the traditional tungsten surface ionization detector is about equally sensitive to K and KBr, Taylor and Datz found that a platinum alloy is much more effective for K than for KBr. From the difference in the signals read on the two detector filaments, they were able to distinguish the small amount of reactively scattered KBr from the large background of elastically scattered K atoms. Small as it was, the little difference bump was a joyful sight. In a series of classic studies in the 1920's, Michael Polanyi had shown that many alkali reactions proceeded at rates corresponding to "reaction at every collision". With this differential surface ionization detector, there was now prospect that crossed-beam studies of many of these reactions could be made with relatively simple apparatus.

Soon I found another intriguing crossed-beam study, published two years before by Bull and Moon at Birmingham. They bombarded a stream of Cs vapor with a pulsed accelerated beam of  $\text{CCl}_4$  produced by swatting with a paddle attached to a high-speed rotor. The intense  $\text{CCl}_4$  beam could be monitored with a simple ionization gauge and signal pulses due to scattered Cs or CsCl were detected by surface ionization on a tungsten filament. Although there was no direct means to distinguish between Cs and CsCl, the observed signal pulses appeared to come primarily from reactively scattered CsCl, on the basis of time-of-flight analysis and blank runs with the  $\text{CCl}_4$  replaced by Hg vapor. Unjustly, these experiments were long discounted or ignored. This was due to the misconception that elastic scattering would always predominate. The high-speed rotor technique also intimidated other prospective experimenters; thus this line early work did not have the impact deserved.

During the spring of 1958, while completing my Ph.D thesis, I visited several universities as a faculty candidate. My seminar about internal rotation was always well received, but my plans for beam experiments sometimes produced outright dismay. Yet the response was often enthusiastic from faculty young in either age or spirit. I was delighted to accept an assistant professorship at

Berkeley, especially since Hal Johnston was now there and also Bruce Mahan, who had the year before completed his Ph.D. at Harvard in kinetics with George Kistiakowsky. My appointment was to take effect a year later; meanwhile I continued at Harvard as a Junior Fellow of the Society of Fellows. The intervening year was extremely useful. It gave me time to work out detailed calculations for design of the beam apparatus and a kinematic theory for interpreting crossed-beam experiments. Membership in the Society of Fellows was also a great pleasure because it brought together intense people from all academic disciplines. Monday night dinners included the two dozen Junior Fellows, ten Senior Fellows and typically ten guests, in a "neo-pickwickian atmosphere" with ample wine and cigars too good to have saved the Stern-Gerlach experiment [7].

Just before departing to Berkeley, I went to say goodbye to Kistiakowsky. Like so many others, I revered him as a scientist and a sage as well as an awesome personality. He confirmed a legendary story about a molecular beam experiment he and Slichter had tried in 1951 to test early theoretical calculations on the properties of supersonic expansions [8]. Because of inadequate pumping speed, the experiment was inconclusive and a miserable struggle. Afterwards, Kisty destroyed the apparatus with an ax! He said to me, with his extra heavy Russian accent (conveying whimsy - or so I hoped): "So you have been bitten by the molecular beam bug. Too bad! The trouble is that there are no collisions in one beam, and no collisions in the other beam, so when you cross them there are still no collisions!"

### Early Alkali Age of Reactive Scattering

At Berkeley, I was soon joined by two graduate students, George Kwei and Jim Norris. Space was in short supply, and we were content with a corner (only  $4\text{ m} \times 6\text{ m}$ ) of a lab in Lewis Hall. Our first task was to remove a large calorimeter that had long occupied that corner; this we viewed as a rite of passage, with the historical perspective of Fig. 1 already in mind. The beam apparatus we installed (dubbed *Big Bertha*) was almost rudimentary. As shown in Fig. 3, the beams were formed by thermal effusion from ovens mounted on turnable which could be rotated to sweep the angular distribution of scattered atoms and molecules past the surface ionization detector. Typically, the distance from the scattering center to the alkali oven was 10 cm, to the other oven 1.5 cm, and to the detector 10 cm. Use of a double-chamber oven for the alkali allowed the temperature of the beam emerging from the upper chamber to be varied by about 300 degrees independently of the vapor pressure established in the lower chamber (about 0.1 torr), which governed the beam intensity. The oven for the reactant gas was connected to an external barostat by a supply tube which passed through the support column in the rotatable lid. Cold shields and collimating slits hid both ovens from the scattering center, and a cold shield also surrounded the detector. The entire scattering chamber was enclosed in a copper box attached to a large liquid nitrogen trap. Since the reactants are condensable, the cold shields and trap provided very high pumping speed. This kept the background vacuum in the scattering chamber low

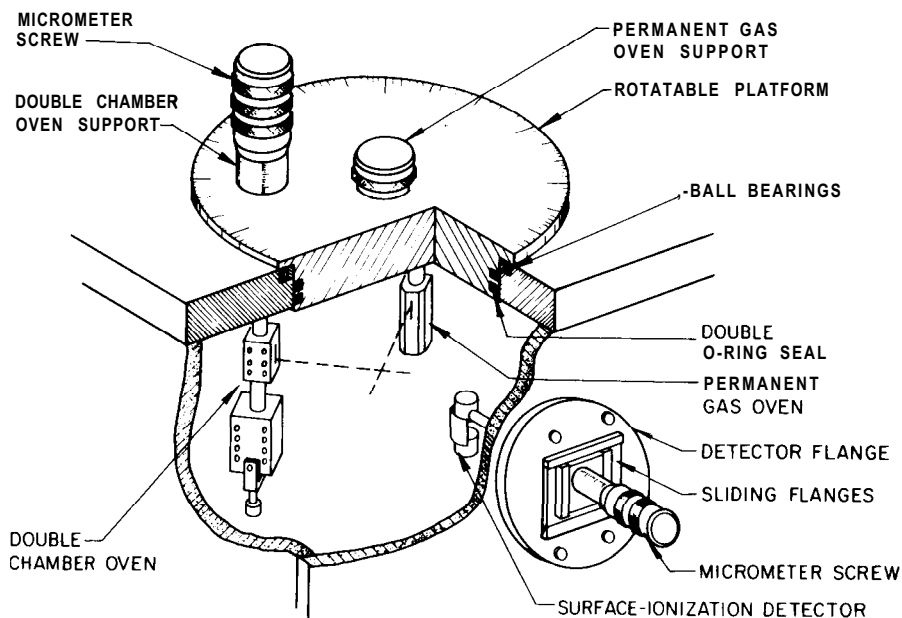

M.U. 29430

Fig. 3. Crossed-beam apparatus *Big Bertha* for study of alkali atom reactions. Cold shields, collimating slits, shutters to interrupt the beams, and other details omitted.

enough (of the order  $10^{-7}$  torr) to ensure that collisions with background gas were negligible for both the reactant beams and the product molecules in flight to the detector.

In typical experiments, the concentration of alkali atoms within the volume defined by the intersection of the beams was about  $10^{10}/\text{cm}^3$ , equivalent to a pressure of  $10^{-6}$  torr, and that of the reactant gas molecules was about 100-fold greater. About  $10^{14}$  alkali atoms/sec entered the reaction volume, of which roughly 0.1-1% reacted to form products while about 10% underwent elastic scattering. The steady-state concentration of products in the reaction volume was roughly  $10^7$  to  $10^8$  molecules/ $\text{cm}^3$ , the pressure about  $10^{-9}$  to  $10^{-10}$  torr. At the peak of the angular distribution of reactive scattering about  $10^{10}$  to  $10^{11}$  product molecules/ $\text{cm}^2/\text{sec}$  arrive at the detector. Since conversion to ions on a hot tungsten or platinum surface is nearly 100% efficient for alkali species, such yields gave readily measureable signals of the order of  $10^{-13}$  Amps. For many of the reactions studied more than a month would be required to deposit a monolayer of product molecules, so it was essential to have a detector far more sensitive than Stern's cigar.

#### *Experiments Revealing Product Recoil*

Our first experiments were begun in the fall of 1960. On the basis of simple theoretical considerations, we decided to try

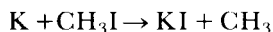

From the angular distribution of the reactively scattered KI we hoped to learn whether there was any preferred direction relating the reactant and product relative velocity vectors and also to get some idea how the reaction energy is partitioned between internal excitation of the product molecules and their relative translational motion. Our rationale was based on the  $\text{CH}_3\text{I}/\text{KI}$  mass ratio. A simple kinematic calculation (displayed later in Fig. 5) showed that this ratio was large enough to permit the detected product KI to recoil sufficiently far away from the centroid to reveal any directional preference, but small enough to inhibit the KI from spraying out so widely that the reactive scattering became too weak to observe. Happily, even the first experiments worked nicely. Our kinematic rationale was vindicated, but it was not until three years later that we learned how lucky was this choice of reaction system; it turned out that  $\text{CH}_3\text{I}$  played the role of Stern's cigar.

Figure 4 shows typical results. In (a), the parent K beam was attenuated 7 % by the perpendicularly crossed  $\text{CH}_3\text{I}$  beam; that represents chiefly elastic scattering. Readings on the platinum detector (solid points) were normalized to those on tungsten (open points) at the parent beam peak. In this case, the use of differential detection was not crucial, as the KI distribution is displaced

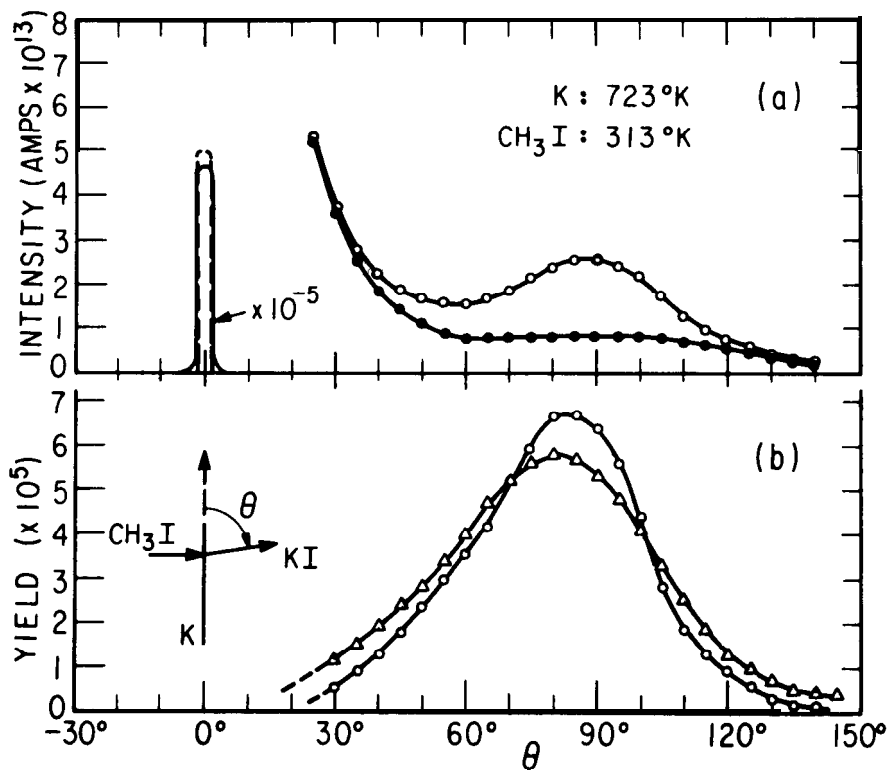

Fig. 4. Reactive scattering data: (a) Parent K beam of  $5 \times 10^8 \text{ A}$  attenuated 7 % by crossed  $\text{CH}_3\text{I}$  beam. Readings on Pt detector (solid circles) normalized to W (open circles) at parent beam peak. (b) KI distributions; circles derived from (a), triangles from a replicate experiment several months later. Area under curves gives collision yield.

far enough from the K beam to appear as a pronounced bump in the signal from the tungsten detector. In (b), the KI distribution is normalized so that the area under the curve gives the collision yield (integrated intensity of KI divided by total K scattered out of the parent beam). This is about  $5 \times 10^{-4}$  and indicated the reaction cross section (or effective target area) is about  $7 \text{ \AA}^2$ . Measurements at several temperatures of the incident beams indicated that the activation energy for the reaction is negligibly small, less than 0.3 kcal/mol. The new dynamical information we were after is contained in the location and shape of the product angular distribution, however. To extract that information we used a kinematic analysis derived from conservation laws that hold regardless of the forces governing the collision.

#### *Kinematic Analysis Via Newton Diagrams*

Velocity vector diagrams such as Fig. 5 are a convenient aid in the kinematic analysis. The vectors pertain to the asymptotic initial and final states of the collision. By virtue of momentum conservation, the center-of-mass velocity vector  $C$  remains constant throughout; only motion relative to  $C$  involves chemical interactions. The recoil velocity  $u$  which carries the product  $KI$  away from  $C$  can have any direction but energy conservation limits its magnitude. Thus, the possible spectrum of recoil vectors  $u$  is represented by a set of

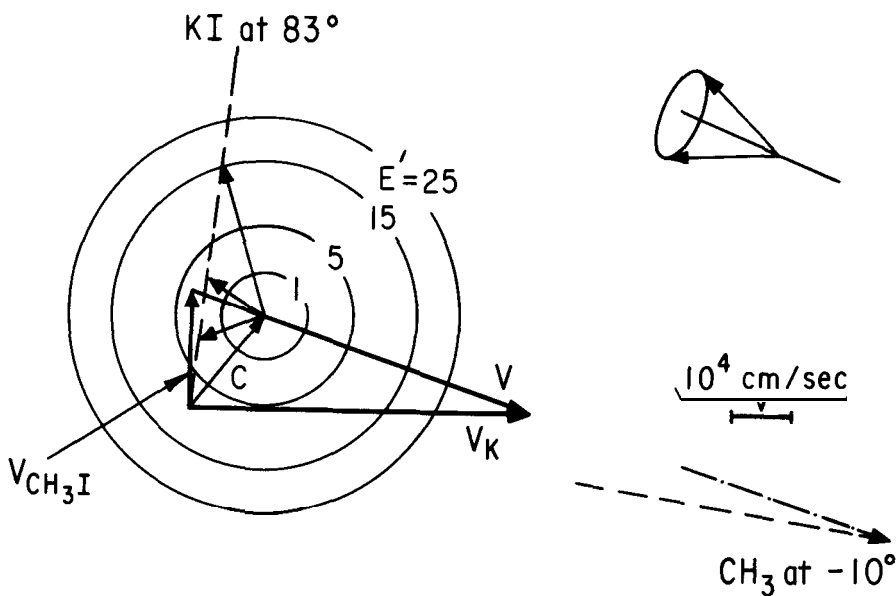

Fig. 5. Newton diagram corresponding to most probable velocities of reactants in Fig. 4. Spheres indicate range of KI recoil vectors allowed by conservation of energy and linear momentum; each is labelled by value of  $E'$ (kcal/mol), the final relative translational kinetic energy. Distribution of recoil vectors must have cylindrical symmetry about initial relative velocity vector, by virtue of "dart board" randomness of collisions. Three sample recoil vectors are shown that correspond to the KI observed at the peak of the angular distribution. Also shown is estimate of most probable recoil vector for  $CH_3$  product.

spheres, one for each accessible value of the final relative translational energy of the products. This energy ranges up to a maximum determined by the initial collision energy and the difference in dissociation energy of the new bond formed and the old bond broken.

From the velocity vector diagram we see that the broad peak observed near  $83^\circ$  in the laboratory corresponds to reactive scattering in which an observer riding with the center-of-mass would see the product KI recoil into the backward hemisphere (and the  $\text{CH}_3$  forwards) with respect to the incoming K beam. Markedly anisotropic scattering of this kind evidently corresponds to a "hard" collision dominated by repulsion, as the K atom, the  $\text{CH}_3$  group, and the center-of-mass of KI must all reverse direction. We called this the *rebound* mechanism. It was later found for many other reactions dominated by repulsion.

Comparison with the velocity vector diagram also permits an estimate of the energy in product relative translation. This affects the displacement of the laboratory angular distribution from that of **C** as computed from the initial conditions. In assessing the displacement, it is necessary to take proper account of a Jacobian factor which enhances the intensity of the laboratory scattering at low recoil velocities. We failed to include this Jacobian in our early work (thereby unwittingly emulating Otto Stern) and hence underestimated the product translation. The correct analysis showed that for the  $\text{K} + \text{CH}_3\text{I}$  reaction about half of the available energy appears in recoil of the products. This result, later confirmed by direct measurement of the **KI** velocity distributions, again exhibited the dominant role of repulsive forces in a *rebound* reaction.

For kinematic analysis, Newton's laws suffice. In the asymptotic translational states the beam molecules are too far apart to interact, hence need not be precisely localized in space and can be assigned definite momenta despite Heisenberg's principle. Accordingly, we named our velocity vector constructions "Newton diagrams". These are still much used today, as kinematic analysis is an essential part of the design and interpretation of any collision experiment.

#### *Frustrations and Preparations*

We were very happy to find this clear evidence for a preferred range of product recoil and energy and were eager to study other alkali atom reactions to look for variations in the scattering patterns that might be correlated with electronic structure. However, we encountered frustrating difficulties with the surface ionization detector. Many reactant gases (other than alkyl halides) poisoned the Pt filament, inducing spurious and irreproducible responses that precluded measurement of reactive scattering. This difficulty stymied us until the fall of 1963, when we finally eliminated it by means of a procedure due to Touw and Trischka. They demonstrated that the Pt filament could be stabilized in either of two distinct modes. The Pt filament becomes essentially *nondetecting* for alkali compounds (but still detects alkali atoms) if it is preheated while doused with methane or another hydrocarbon. The Pt filament becomes *detecting* for alkali compounds and acts just like a W filament if it is instead preheated while

doused with oxygen or merely operated in sufficiently clean vacuum. The nondetecting mode evidently requires a stable carbon layer on the filament. Thus, the differential detection so useful for alkali reactive scattering results from a dirty surface. Before the preheating procedure was developed, the carbon deposit was a matter of luck, supplied either by pump oil vapor if the vacuum were poor or by hydrocarbon-rich reactant species such as methyl iodide; either acted like Stern's cigar.

During the lean period of more than two years before rescue by a dirty detector, our only successful reactive scattering experiments dealt with variants of the  $K + CH_3I$  reaction, involving other alkali atoms and alkyl groups with up to seven carbon atoms. However, in this period our research group expanded rapidly and we constructed much new apparatus, experimental and theoretical, that was destined to bring a harvest of results. Jim Kinsey, Ken Cashion, Mark Child and Malcolm Fluendy joined as postdoctoral fellows, and Phil Brooks, Kent Wilson, John Birely, Ron Herm, Jim Cross and Dick Zare as graduate students. Figure 6 provides a succinct summary, indicating the chief projects pursued by this distinguished roster during our Berkeley era.

In particular, we note among the apparatus construction projects three analyzing devices: rotating slotted-disk velocity selector, inhomogeneous magnetic deflecting field, and inhomogeneous electric deflecting field. These devices are quite similar to those used by Otto Stern; we liked to say that reactive scattering followed the evolutionary principle, "Ontogeny recapitulates Phylogeny". As seen already, velocity analysis was essential to obtain quantitative

*Molecular Collisions  
at Berkeley  
July 1959 - July 1963*

*M.A.D. Fluendy* Atom scattering

*R. J. Cross* Rigid rotor scattering

*M. S. Child* Semiclassical\*  
inelastic collisions

*J. K. Cashion* Diatom potentials

*J. H. Birely* Kinematics, Velocity analysis

*R. R. Herm* Magnetic & Electric deflecting fields

*R. N. Zare* Photodissociation, Angle & Doppler

*K. R. Wilson* Charity, Surface ionization, Mass filter

*P. R. Brooks* Dodo, Kingdom cage, Elastic scattering ★

*J. L. Kinsey* } Eve, Faith ★

*J. A. Norris* } Bertha } M+RI, optical model ★

*G. H. Kwei* } K+CH<sub>3</sub>I, Rebound Velocity selector, Gloria

---

59      '60      '61      '62      '63      '64

Fig. 6. Roster of graduate students and postdoctoral fellows with chief research projects during Berkeley era. Our first apparatus was a helium leak detector called Annie; hence our successive beam machines were named Bertha, Charity, Dodo, Eve, Faith, Gloria. Stars indicate completion of Ph. D. theses or postdoctoral terms.



data for the recoil angle and translational energy distributions. Magnetic analysis provided, among other things, a definitive test of our detection technique, immune to poisoning of the filaments. By deflecting away most of the paramagnetic alkali atoms, we could measure directly the distribution of diamagnetic alkali halide molecules produced by reactive scattering. Electric deflection of these polar molecules enabled us to determine the rotational angular momentum. This had special appeal for me because of my background in rotational spectroscopy. Furthermore, since mass, velocity, and position all enter into angular momentum, it was clearly a key property for theoretical models of reaction dynamics.

Among our theoretical studies of this period was a treatment of the velocity vector distribution of fragments from molecular photodissociation. This was undertaken because already we had vague notions of a kinship between chemical reactions and photodissociation. In electronic excitation by photons, the angular dependence is determined simply by the dipole selection rule whereas the exit velocity of the photofragments is determined by the repulsive potential of the excited state. This "half-collision" model, worked out nicely by Dick Zare, provided rather general "form factors" for numerous properties [9]. Subsequently, this has served as the basis for extracting a lode of information about dissociative excited states by means of laser spectroscopy, and the suspected link with reaction dynamics did indeed emerge.

Our Berkeley days also included several memorable visits with others captivated by reaction dynamics. One of these occurred in the early summer of 1961, when I visited Don Bunker at Los Alamos. He had undertaken the first realistic Monte Carlo calculations of classical trajectories for chemical reactions, and his initial aim was to interpret our results for the  $K + CH_3I$  system in terms of potential surface features. The scene in his office comes back vividly [10]:

He was decorating the walls with strips of recorder chart paper several yards long, on which were plotted a series of undulating, intertwined curves. These were the first results of his Monte Carlo calculations... The room was bright with sunshine and the varicolored curves seemed to shimmer and dance about, as if choreographed to Don's crisp and witty description. It was an exhilarating moment. Henceforth the mechanics of molecular collisions for any postulated force field could be computed, as he liked to say, "in instructive and entertaining detail."

Such classical trajectory calculations, as developed especially by Martin Karplus and John Polanyi, have indeed proven invaluable for interpreting data and testing concepts of reaction dynamics.

Other inspiring encounters came in April, 1962, at a Faraday Society Discussion held at Cambridge University, where I met many leading workers in chemical kinetics. Equally inspiring was a solo visit to Berkeley a few months later by Michael Polanyi. He witnessed an unsuccessful scattering experiment on the  $K + Br_2$  reaction while he described to us his prescient speculations of 30 years before that it might proceed by a stripping mechanism with high vibrational excitation of the  $KBr$  product. He also mentioned that he liked to

think that the attacking alkali atom used its valence electron to "harpoon" the halogen. Later I adopted this term to enliven numerous discussions of electron transfer reactions.

*From Rebound to Stripping with Rainbows Between*

Within a few months my group was discussing an unanticipated transfer to Harvard. We had expected to relocate in a new lab about 100 m away in the basement of the nearly completed Latimer Hall, but in the late summer of 1963 instead moved 5000 km to the basement of Mallinckrodt Laboratory. I went even further that summer, as I'd agreed to present a lecture course on molecular collisions at Göttingen University. There I strolled daily along the path atop the encircling medieval wall, the path taken by many of the pioneers of quantum mechanics during ambulatory debates. But only by communing with the charming little Goose Girl in the Rathaus fountain was I reconciled to the quantum-like dualities of the Harvard/Berkeley choice.

Our new lab was in nearly full swing by Halloween and soon we learned how to avoid poisoning our detector filaments. Thereafter results were rapidly obtained for a wide range of alkali reactions. As illustrated in Fig. 7, many showed striking contrasts to the methyl iodide reaction. We found that for

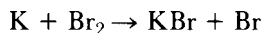

and similar systems the reaction cross section is remarkably large,  $\sim 200 \text{ \AA}^2$ , and most of the alkali halide product recoils into the forward hemisphere with respect to the incident alkali atom. These features indicate dominantly attractive interaction in which the bond exchange can occur for quite large impact parameters. This suggests a *stripping* mechanism of the type familiar in nuclear physics. In an independent study of the  $\text{Br}_2$  reaction, Minturn and Datz obtained similar results and many other examples of *stripping* reactions were soon found.

Before long, we had examples for which the reaction cross section is of intermediate size and the product peaks sideways, giving a conical angular distribution about the direction of the initial relative velocity vector. Such a case is the reaction

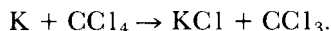

A strong correlation emerged: as the magnitude of the total reaction cross section increases, the preferred recoil direction of the alkali halide product shifts forwards. This is exemplified as  $\text{K} \rightarrow \text{Rb} \rightarrow \text{Cs}$  for the  $\text{CCl}_4$  reaction, whereas the angular distributions do not change much with the identity of the alkali atom for the  $\text{CH}_3\text{I}$  case or the  $\text{Br}_2$  case. Velocity analysis experiments likewise show a nice contrast. The product translational energy is large for the  $\text{C H}_3\text{I}$  case and small for the  $\text{Br}_2$  case, but the angular distributions do not change much with the exit energy. For the  $\text{CCl}_4$  reaction, the preferred direction of the product moves forward rapidly as the translational recoil energy increases. The form of this strong angle-energy coupling resembles the *rainbows* familiar in elastic scattering of molecules and in sunny but moist skies.

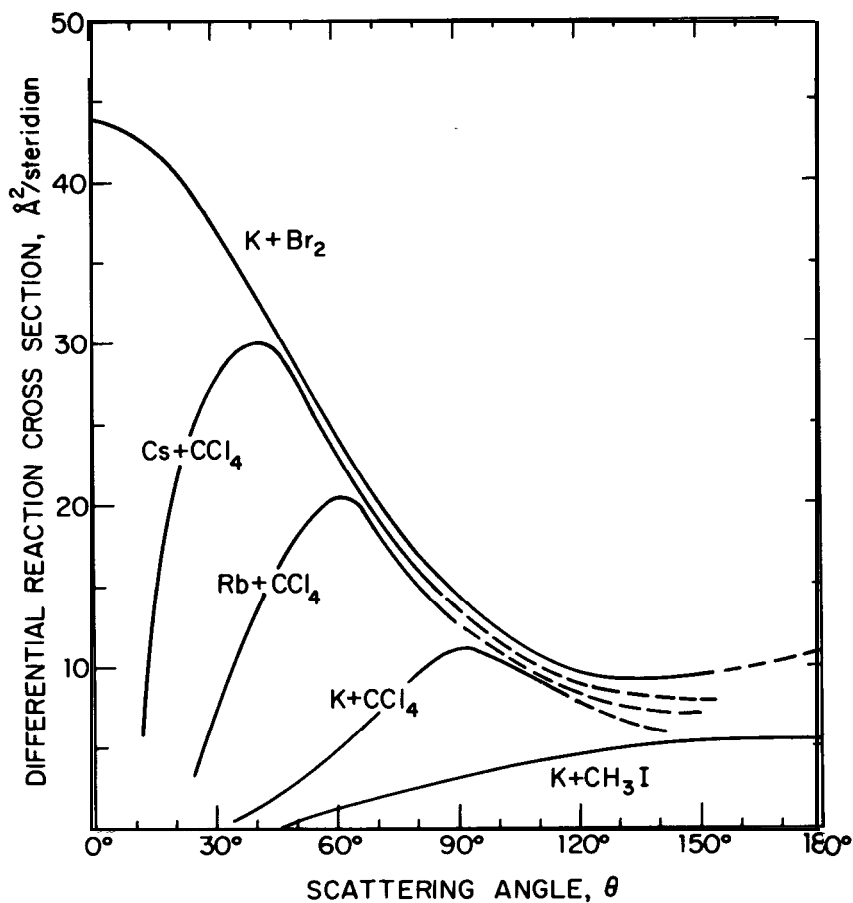

**Fig. 7.** Comparison of scattering angle distributions for reactions of alkali atoms with  $\text{Br}_2$ ,  $\text{CCl}_4$ , and  $\text{CH}_3\text{I}$ , illustrating stripping, transitional, and rebound behavior. Ordinate scale indicates approximate normalization to total reaction cross sections. Distributions show angular variation that would be seen by a hypothetical observer traveling with the center-of-mass. Scattering angle indicates deviation of product relative velocity from reactant relative velocity; for  $\theta = 0^\circ$ , the alkali halide emerges in same direction as incident alkali atom.

The marked anisotropy of the product angular distributions for this family of reactions, ranging between rebound and stripping, indicates that all proceed by a *direct* or *impulsive* mechanism. The duration of the reactive collisions must be so short that most of the transient collision complexes decompose before rotating through  $180^\circ$ . Since the rotational velocities are quite high, roughly half or more of the complexes must decompose within about  $5 \times 10^{-13}$  sec, a time not much longer than a vibrational period.

The dynamical properties and chemical variations found for these alkali reactions were well suited to the early Monte Carlo trajectory studies and also prompted several insightful heuristic models. Ironically, trajectory studies of product angular distributions suffered at first from an instructive malady akin to the poisoning problem that had held up our experiments. The calculations

for atom exchange reactions,  $A + BC \rightarrow AB + C$ , used plausible forms of potential energy surfaces with empirical parameters. These surfaces were constructed by adding up pairwise interactions modulated by switching functions to weaken each bond as the collision partner draws nigh. Blais and Bunker found that reactive trajectories for such surfaces gave chiefly backward scattering, in satisfying agreement with our first experiments. But this rebound behavior was unduly prevalent; for about two years after the discovery of stripping and rainbow-like reactive scattering, trajectory calculations remained unable to obtain anything but backward scattering. Godfrey and Karplus cured this affliction using potential surfaces derived from approximate quantum mechanical secular equations. This ensured a smooth surface, free from spurious bumps and wrinkles that appeared in surfaces constructed by adding piecewise interactions. It was "contamination by such warts" that induced too much backward scattering. By varying the repulsive or attractive character of the wartless surfaces, the trajectory calculations nicely elucidated the various trends associated with transition from rebound to stripping. Likewise, trajectory studies by John Polanyi and his students mapped out the systematics of energy disposal among product translation, vibration, and rotation.

We now could also relate these general dynamical properties of alkali reactions to the electronic structure of the target molecules. All these reactions involve converting a covalent bond into an ionic bond, and in effect are gas-phase acid-base or ion-recombination processes, via

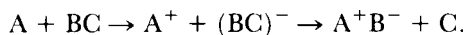

According to Michael Polanyi's *harpooning* model, the attacking alkali atom tosses out its valence electron, hooks the halogen-containing molecule, and hauls it in with the Coulomb force. The basic features of the initial electron transfer had been examined as early as 1940 in an exemplary theoretical study by Magee. As pictured schematically in Fig. 8, the transfer occurs in the vicinity of "curve crossing" between zeroth-order "purely covalent" and "ion-pair" potential surfaces. When the crossing radius  $r_c$  is large enough, Coulombic attraction is dominant there and this radius may be estimated from

$$e^2/r_c = IP(A) - EA(BC),$$

the difference in the ionization potential of the alkali atom and the electron affinity of the target molecule. This relates the size of the reaction cross section to the energy required to create the ion-pair.

However, the dynamical properties are also greatly influenced by the exit interaction as the  $A^+$  ion approaches the intermediate molecule-ion  $BC^-$ , which is severely distorted by the strong electric field and dissociates. Accordingly, many dynamical features will differ with the shape and particularly the location of the asymptote of the potential curve for the negative molecule ion. Often we could estimate the relevant potential curves for the  $BC^-$  ion from data obtained in electron impact experiments or by means of arguments developed by Mulliken for the analysis of charge-transfer spectra. Figure 9 classifies some of the possibilities.

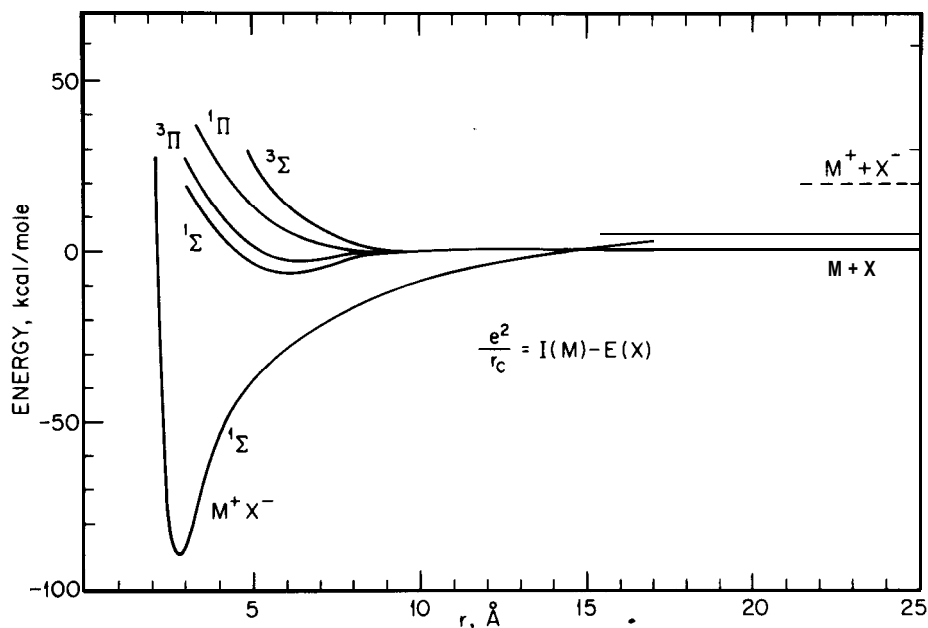

Fig. 8. Potential energy curves for an alkali halide molecule (drawn for KBr) showing the “zeroth-order” crossing of the ionic and covalent states.

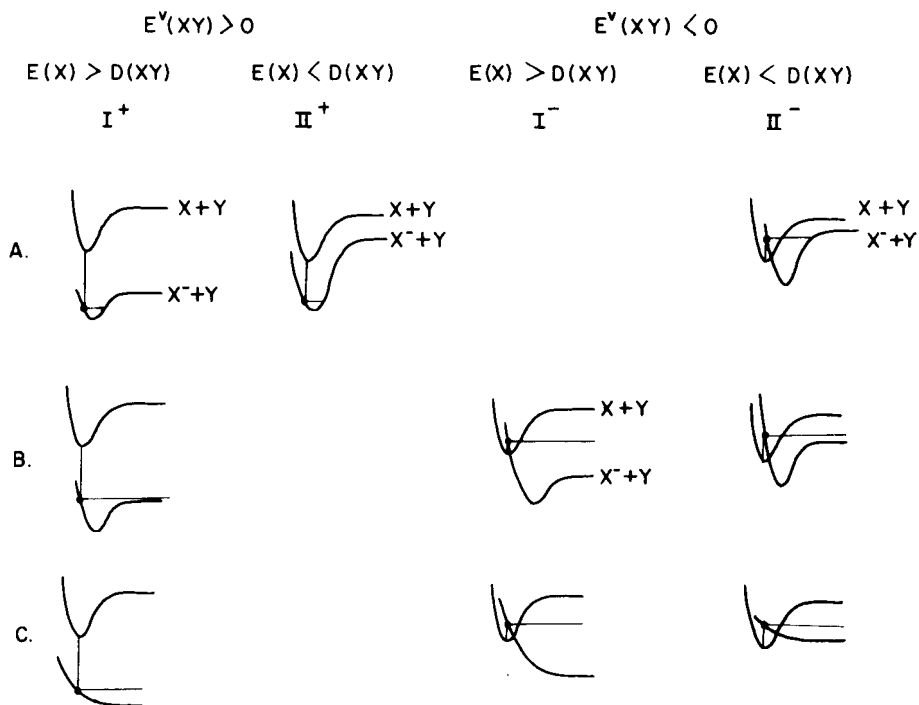

Fig. 9. Classification of electron attachment processes producing negative molecule-ions ( $XY + e \rightarrow XY^-$ ). Here  $D$  denotes the bond dissociation energy,  $E$  the adiabatic and  $E^v$  the vertical electron affinity.

For instance, the case designated  $I^-C$  pertains to the  $CH_3I$  reaction and many other examples of rebound reactions. The negative ion is then formed in a strongly repulsive state, because the harpooning electron enters a strongly antibonding molecular orbital with a node between the originally bonded atoms. This is usually the same orbital that governs photodissociation of the parent molecule, so we could derive the location and shape of the exit potential curve from its absorption spectrum.

In contrast, the case designated  $I^+A$  pertains to the  $Br_2$  reaction and many of the prototype stripping systems. These involve exceptionally large electron affinities, which accounts for the very big reaction cross section and the long-range attraction that gives forward scattering. Here the intermediate negative molecule ion would be stable in the absence of the positive ion, although highly excited vibrationally. But when the ions are within the crossing radius of about  $7 \text{ \AA}^2$ , the Coulomb field exceeds  $3 \times 10^9 \text{ V/cm}$  and thus the negative ion will be pulled apart in a time comparable to a vibrational period, or  $\sim 10^{-13}$  sec. This accounts for the direct character of the reaction. However, the transient attractive coupling between B and C in the exit channel has a major role in the energy disposal.

The harpooning model prompted treatments of many other properties, such as the mechanics of curve crossing and dissociative electron attachment, orientation dependence, and orbiting outside a centrifugal barrier at the crossing radius. But in terms of chemical perspective, the most striking aspect was the connection to charge-transfer spectra. In retrospect, the detection-imposed limitation of early beam studies was fortunate, as this alkali family was ideally suited for relating reaction dynamics to the electronic structure of reactant molecules.

#### *Elucidating Polanyi Flame Reactions*

As well as demonstrating very large reaction rates, the classic studies of alkali-halogen reactions by Michael Polanyi also revealed intense emission from electronically excited alkali atoms. This had a major role in early discussions about interaction of electronic and nuclear motions, as the Polanyi flames preceded by a few years the Born-Oppenheimer and Franck-Condon approximations, both found in 1925. Some central questions concerning the chemiluminescence remained unresolved 40 years later, however, when we undertook beam experiments to examine each of the postulated elementary steps in the flame mechanism. Again, the results exemplified prototypical aspects of electronic structure.

One of the key steps producing chemiluminescence involves *vibrational-to-electronic* energy transfer. This we studied by means of a "triple-beam" experiment. Vibrationally excited  $KBr^\dagger$  was formed at the intersection of crossed beams of K and  $Br_2$  and sent into a second scattering chamber containing a Na crossed beam, where fluorescence from  $K^*$  was observed. The cross section found for this *reactive transfer* process,

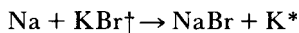

is very large,  $10-100 \text{ \AA}^2$ , whereas that for *nonreactive transfer* via

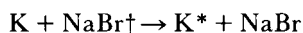

is at least tenfold smaller. (The dagger denotes high vibrational energy, the asterisk denotes the lowest  $^3\text{P}$  excited electronic state.) This result is interesting because the initial energy distributions of the reactants are nearly the same in the  $\text{Na} + \text{KBr}^+$  and the  $\text{K} + \text{NaBr}^+$  experiments and the same set of potential surfaces is accessible in both cases. On energetic or statistical grounds, both processes might have been expected to form  $\text{K}^* + \text{NaBr}$  with the same probability. The interpretation becomes clear when the ionic character of the bonding is considered. If in the intermediate  $(\text{AB})^+\text{X}^-$  complex the  $(\text{AB})^+$  ion decomposes rapidly and irreversibly in the field of the  $\text{X}^-$  ion, configurations in which both A and B are symmetrical with respect to both charge-sharing and interaction with  $\text{X}^-$  may seldom be traversed. The chemical exchange process  $(\text{A} + \text{B}^+\text{X}^- \rightarrow \text{A}^+\text{X}^- + \text{B}^*)$  is then more favorable for electronic excitation because it involves charge-transfer ( $\text{B}^+ + e \rightarrow \text{B}^*$ ) whereas the nonreactive process  $(\text{A} + \text{B}^+\text{X}^- \rightarrow \text{A}^* + \text{B}^+\text{X}^-)$  does not involve charge-transfer. Later, we found *translational-to-electronic* energy transfer for these systems exhibits the same strong preference for reactive over nonreactive transfer, although the cross sections are a thousandfold smaller. Potential surface calculations indicate this preference appears to involve a "stereospecific" orientation dependence. The potential surfaces for the ground and excited states remain widely separated except for nearly collinear configurations with the halogen between the two alkali atoms.

In the other major chemiluminescent step, the same potential surface complex is reached via harpooning,  $\text{X} + \text{AB} \rightarrow (\text{AB})^+\text{X}^- \rightarrow \text{A}^+\text{X}^- + \text{B}^*$ . This we studied by generating a beam of halogen atoms from thermal dissociation in a graphite oven and a beam of alkali dimers from a supersonic expansion. Contrary to previous indirect evidence, our beam experiments showed that this step occurs with a large cross section,  $\sim 10 \text{ \AA}^2$ . A "degeneracy-induced" excitation mechanism proposed long before by Magee was thereby vindicated. The reactant halogen atom has three-fold orbital degeneracy, corresponding to location of its valence-shell "hole" in the  $p_x$ ,  $p_y$ , or  $p_z$  orbital, whereas the reactant and product molecules are in nondegenerate electronic states. Thus the reactants give rise to three distinct potential energy surfaces but only one of these can lead to the nondegenerate ground state of the product alkali atom and the other two surfaces must lead to electronically excited states.

Many other aspects of the harpooning mechanism were revealed in subsequent studies of electronic excitation processes [11]. Particularly striking was evidence for an "internal reflection" mechanism. This is illustrated in Fig. 10 for  $\text{K} + \text{SO}_2$  collisions. Intense emission of  $\text{K}^*(^3\text{P})$  fluorescence is seen at collision energies above the endoergicity (1.6 eV) for this excitation. The emission increases strongly up to the threshold (3 eV) for formation of  $\text{K}^+ + \text{SO}_2^-$  ion-pairs and then declines steeply. At energies above the  $\text{A}^* + \text{X}$  asymptote but below the  $\text{A}^+ + \text{X}^-$  asymptote, trajectories which make the  $\text{A} + \text{X} \rightarrow \text{A}^+\text{X}^-$  crossing and intend to exit via the ion-pair channel find it

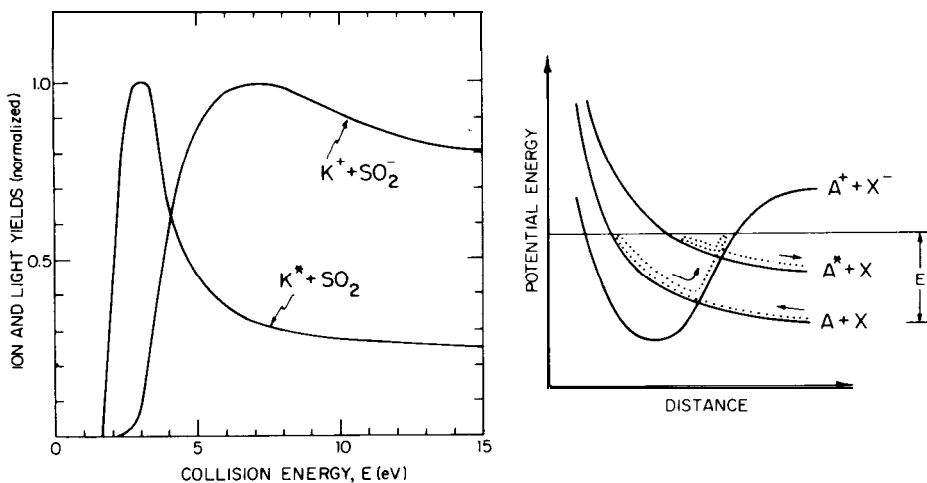

Fig. 10. Cross sections for electronic excitation and ion-pair formation on impact of K atoms with  $\text{SO}_2$  molecules, as functions of initial relative kinetic energy. Schematic potential curves at right show reaction path illustrating "internal reflection" mechanism.

closed. This flux must be reflected back and redistributed at the  $\text{A}^+\text{X}^- \rightarrow \text{A}^* + \text{X}$  and  $\text{A}^+\text{X}^- \rightarrow \text{A} + \text{X}$  crossings until ultimately it escapes via either the excitation channel or the original entrance channel.

#### *Persistent Collision Complexes with Glorys Galore*

Until late 1966, the alkali reactions studied in crossed beams or in Polanyi flames all converted a *covalent* bond into an *ionic* bond, and all appeared to involve abrupt, *impulsive* reaction dynamics. Likewise, by then trajectory calculations for  $\text{A} + \text{BC}$  reactions had explored a variety of "mountain-pass" and "ski-run" potential energy surfaces, and found that the lifetime of the transient  $\text{A-B-C}$  complex is usually too short for rotational or even vibrational motions; the products typically emerge within  $10^{-13}$  sec or less. However, we expected that suitable systems would form a lingering or *persistent* complex with lifetime long compared to rotational as well as vibrational periods. In this regime, the angle and energy distributions of the scattered products would give information about the *unimolecular* decomposition of the complex.

Among alkali reactions likely candidates were the exchange reactions with alkali halides,

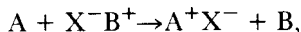

at ordinary thermal energies, too low to permit electronic excitation. For these *ionic*  $\rightarrow$  *ionic* reactions, since an ion-pair is present throughout, electron transfer can enhance attraction rather than induce exit repulsion. Furthermore, the near equality of the  $\text{A}^+\text{X}^-$  and  $\text{B}^+\text{X}^-$  bond strengths and the exceptional stability of the diatomic alkali molecule-ions (just then confirmed in the Ph.D. work of Yuan Lee with Bruce Mahan) favor formation of an  $(\text{AB})^+\text{X}^-$  complex of appreciable lifetime. Electronic structure calculations subsequently de-



monstrated that the potential energy surfaces for dialkali halides indeed have a pronounced basin, corresponding at its minimum to a triangular complex stable by about 10 kcal/mol or more with respect to the separated products.

With the aim of studying these alkali atom + alkali halide reactions, before departing Berkeley we had begun constructing an apparatus with a mass spectrometer behind the surface ionization filament, to provide differential detection for both of the product species and both of the reactant species. Walter Miller and Sanford Safron completed the apparatus at Harvard and obtained lovely evidence for persistent collision complexes in more than a dozen of these exchange reactions. In each case, the angular distribution of products has symmetry about  $90^\circ$  and peaks very strongly near  $0^\circ$  and  $180^\circ$ . Furthermore, at wide angles the nonreactive scattering shows a "sticky collision bump" arising from break-up of the complex to reform the reactants rather than proceed to products.

We found the angular distributions could be nicely interpreted in terms of a statistical model adapted from the compound nucleus treatment of nuclear fission. The symmetry about  $90^\circ$  indicates that the complex persists for at least a few rotational periods and hence many vibrational periods. This permits a rough estimate of  $5 \times 10^{-12}$  sec as a lower limit for the mean lifetime of the complex. The strong peaking at  $0^\circ$  and  $180^\circ$  indicates that the typical complex forms and dissociates with centrifugal angular momentum much larger than the rotational momenta of the reactant or product salt molecules. As illustrated in Fig. 11, the products emerge with equal probability at all azimuthal angles about the total angular momentum vector  $\mathbf{J}$  of the complex, like water from a lawn sprinkler. The complete angular distribution is obtained by averaging uniformly over all orientations of the sprinkler about the relative velocity vector  $\mathbf{V}$  of the reactants. The result corresponds to the intersections of circles of latitude and longitude on a globe. The product intensity is low in the equatorial regions but becomes very high in the polar regions, near  $0^\circ$  and  $180^\circ$ . This prominent peaking forward or backward along  $\mathbf{V}$  is called a "glory", after an analogous effect in light scattering from raindrops.

The glory peaks are rounded off when much of the angular momentum  $\mathbf{J}$  appears in rotational tumbling of the reactant or product molecules rather than centrifugal motion. As seen in Fig. 11, this tilts the spinning sprinkler away from the polar regions. The shape of the product angular distribution thus reveals the relative contribution of the centrifugal and tumbling motions. This is illustrated in Fig. 12. In turn, the statistical model links the angular momentum disposal to the moments of inertia of the complex in the transition-states for formation and decomposition. The arrangement of atoms and the rotational motions in the transition-state thereby can leave its imprint in the product angular distribution, even though the complex may dissociate after only a few rotations.

The product energy distributions are more directly related to properties long familiar in the theory of unimolecular reaction rates. The main features are governed primarily by the statistical densities of rotational and vibrational states at the transition-state, as in the Rice-Ramsberger-Kassel-Marcus treat-

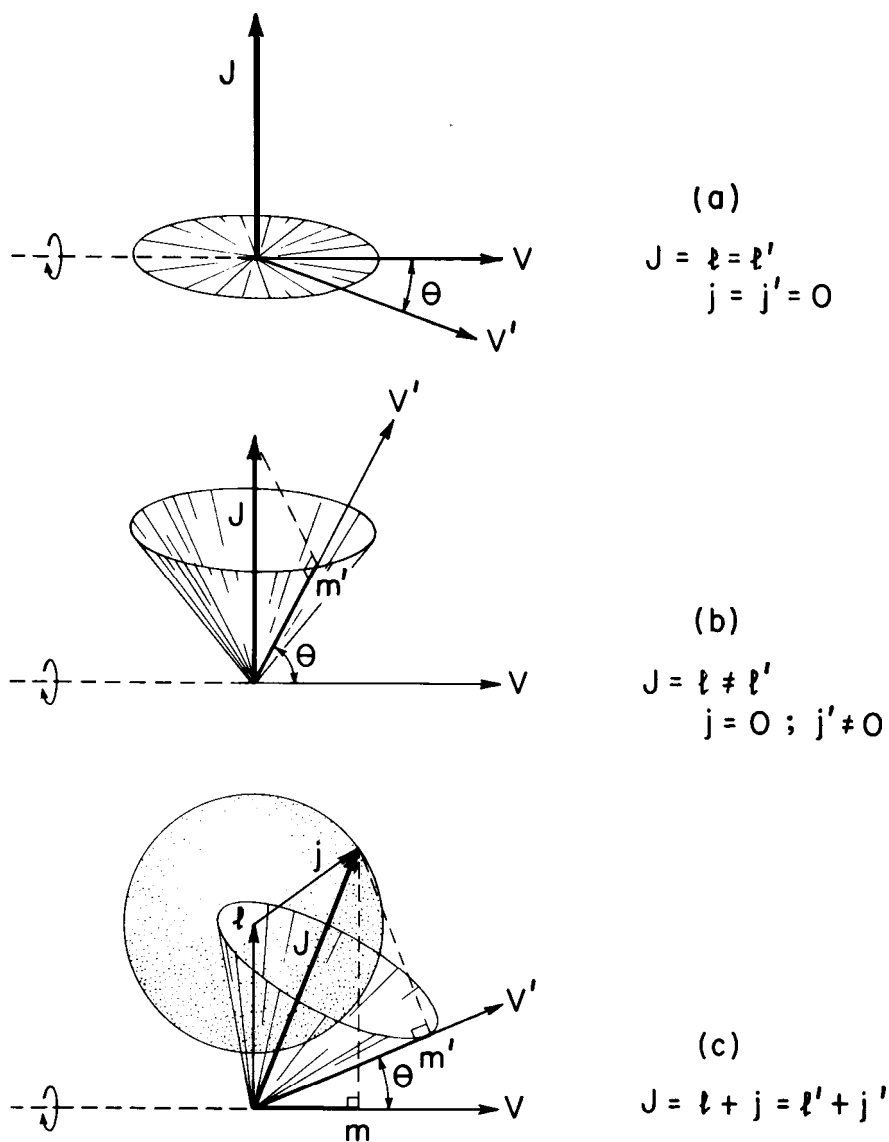

Fig. 11. Relationships among initial and final angular momenta and relative velocity vectors for a long-lived collision complex. In case (a) there is no rotational momentum for either the reactant or product molecules; in (b) it is present only for the products; in (c) for both reactants and products. For fixed magnitudes of the total angular momentum  $J$  and the projections  $m$  and  $m'$  on the relative velocity vectors the product angular distribution is generated by uniform precessions of  $V'$  about  $J$  and  $J$  about  $V$ .

ment of unimolecular rates. Qualitative aspects are illustrated in Fig. 13. In partitioning the available energy among relative translation, vibration, and rotation of the products, the statistically favored situation puts only a small part into translation, since the vibrational and rotational modes are more numerous. Thus, the probability distribution decline rather rapidly with incre-

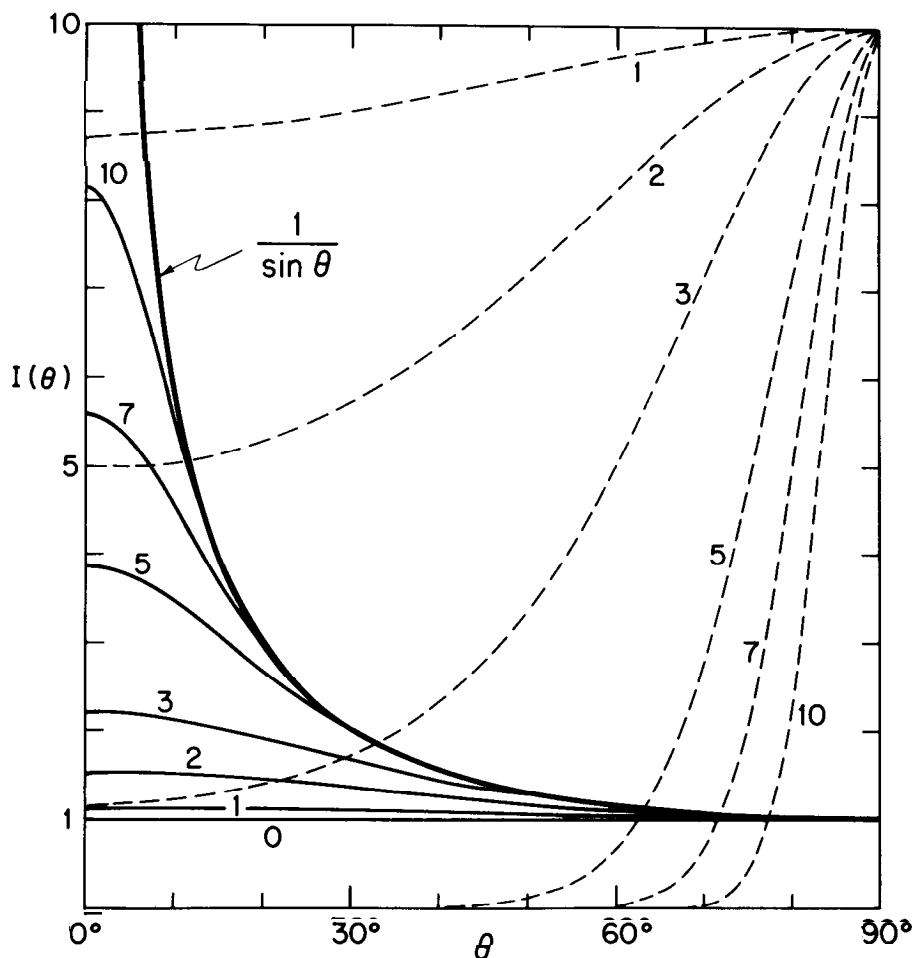

Fig. 12. Angular distributions for the statistical complex model, averaged over distributions of angular momenta appropriate to a prolate complex (solid curves) or an oblate complex (dashed curves), for case (b) of Fig. 11. All the curves are symmetric about  $90^\circ$ . The index gives the ratio of the maximum value of reactant orbital angular momentum  $\mathbf{I}_{\max}$  to the average value of the projection  $\mathbf{m}'$  for the dissociating complex; thus the index indicates the relative contribution of centrifugal and tumbling motions.

ase in product translational energy. This decline becomes more rapid as the number of atoms in the complex increases and hence the number of vibrational modes increases. Another effect enters when the complex is rotating, however. The energy in centrifugal motion is not available for statistical distribution among the other modes. On decomposition of the complex this centrifugal energy is converted into relative motion of the emerging product molecules. This changes the shape of the product translational energy distribution. The low energy region is determined by the centrifugal contribution, the high energy region by the statistical contribution.

As outlined here, the statistical model pertains to a "loose" complex defined by the exit and entrance centrifugal barriers associated with long-range attrac-

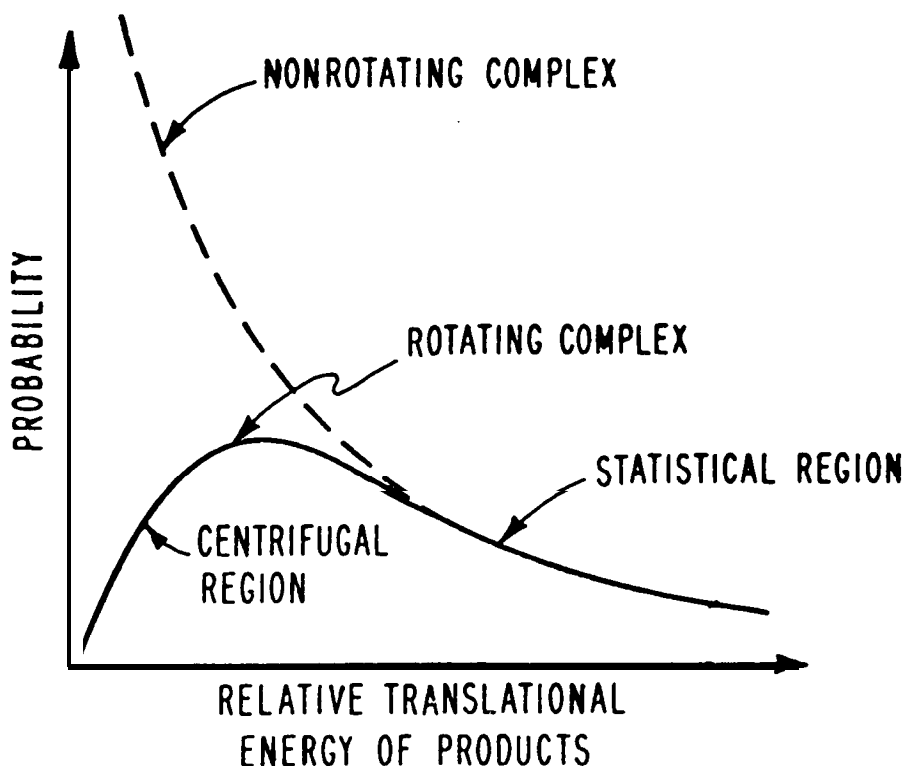

Fig. 13. Schematic distribution of product relative kinetic energy as predicted from statistical theory, without (dashed) and with (solid) the centrifugal contribution that enters for a rotating complex.

tion. Within these barriers, the energy disposal is assumed to be statistical; outside, the collision partners are assumed to rotate freely and travel like point masses subject to two-body forces. This simple model has worked well for many reactions, although various refinements are needed for quantitative analysis. Other basic factors enter for a "tight" complex. The transition-state then occurs at a potential barrier rather than a centrifugal barrier, and bond deformations are required to surmount the barrier. This implies that energy can be exchanged between different degrees of freedom as the system moves from the transition-state to the separated products. With allowance for such effects, statistical treatments akin to the RRKM theory usually prove adequate in the persistent complex realm.

A major, instructive discrepancy appeared for the dialkali halide systems, however. Despite its good agreement with the angle and energy distributions, the statistical model overestimated the ratio of reactive to nonreactive decay of the collision complex, often by a factor of 3 to 5 or more. This striking discrepancy is attributed to preferred reaction geometry. The potential energy surfaces predict that the preferred direction of approach is collinear, with the incoming alkali atom attacking the "wrong end" of the salt molecule. This

corresponds to linear  $(AB)^+X^-$  and reflects the stability of the dialkali ion. By virtue of the strong long-range attraction, most complexes are formed in collisions with large impact parameters and thus the centrifugal momentum often restrains the roughly collinear  $(AB)^+X^-$  configurations from bending into the triangular configurations required for reaction. Later, we found many similar instances of preferred reaction geometry.

In search of another prototypical deviation from the statistical case, we looked for a collision complex with lifetime comparable to its mean rotational period. This is called an *osculating* complex, a term applied by Wigner to an analogous realm in nuclear reactions. As indicated in Fig. 14, our model calculations for this case assume that during rotation about its total angular momentum  $J$  the complex is subject to decomposition with a random lifetime

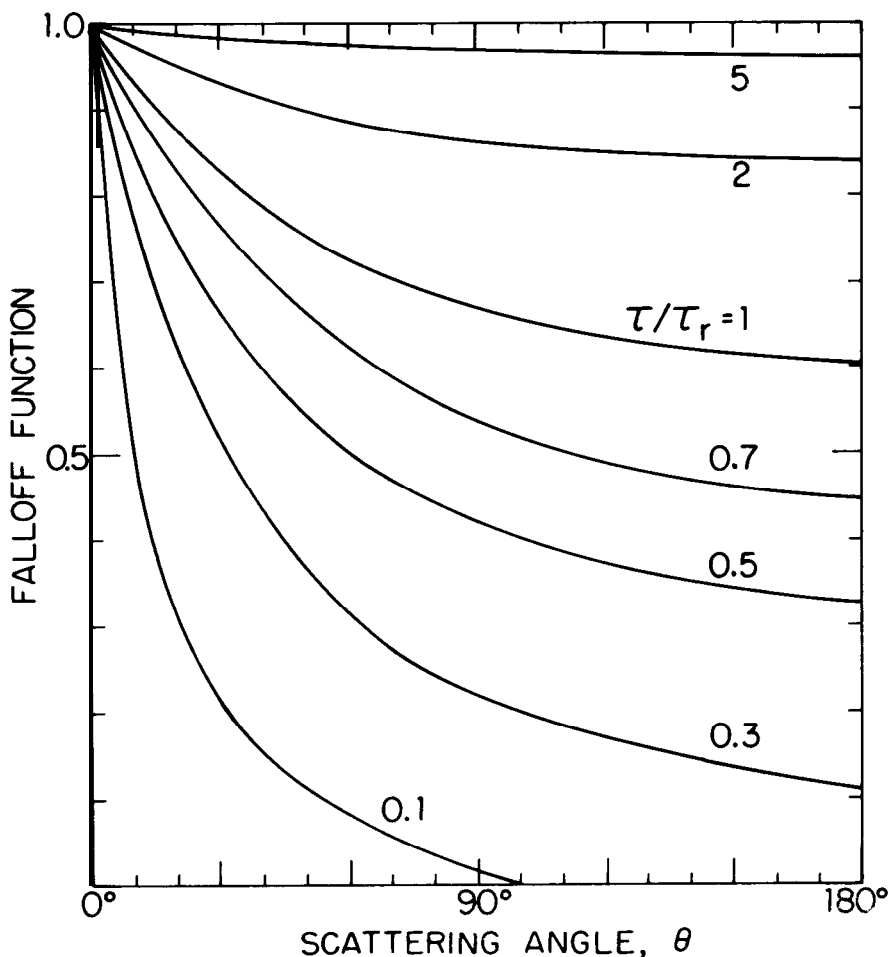

Fig. 14. Ratio of intensity appearing at angle  $\theta$  to the peak intensity for forward scattering ( $\theta=0^\circ$ ) as calculated for the *osculating model*. The corresponding angular distribution is obtained by multiplying this "falloff function" by the appropriate curve from Fig. 12. The falloff curves are labelled by the ratio of the mean lifetime of the complex to a typical rotational period.  $\tau/\tau_r$ .

distribution,  $\exp(-\tau/\tau_r)$ . This gives an angle-dependent form factor governed by the ratio  $\tau/\tau_r$  of the mean lifetime to a typical rotational period. The angular distribution is approximated by multiplying that for a persistent complex by this factor. For  $\tau \sim 5\tau_r$  we thus expect the forward and backward glory peaks to be about equally strong, whereas for  $\tau \sim \tau_r$ , the backward peak should be attenuated by about 50%. Reactions of alkali atoms with thallium halides were examined as likely candidates. We expected the lifetime of the complex might be shortened by the higher ionization potential of the Tl atom, which inhibits the sharing of charge, and by the higher reaction exoergicity. Indeed, George Fisk and Doug McDonald found these systems show the glory peaks characteristic of a complex, but the backward peak is substantially weaker, by 30% to 50%. Again, similar behavior was later found for many other reactions. Attractive chemistry often yields not a persistent coupling but just a flirtatious whirl.

Another aspect of unimolecular kinetics explored with alkali reactions is the dependence on the number of degrees of freedom. Even some *covalent*  $\rightarrow$  *ionic* reactions with sizable exoergicity proved to involve persistent or osculating complexes when six or eight atoms are involved. The most fully characterized example is the Cs + SF<sub>6</sub> reaction; in addition to angle and velocity distributions, we measured the CsF rotational excitation by electric deflection and the vibrational populations by electric resonance spectroscopy. Although the available energy is rather large, 40-50 kcal/mol, the reaction appears thoroughly statistical. It has symmetrical forward and backward glory peaks and the same effective temperatures for translation, rotation, and vibration, corresponding to equipartition of energy. In this study, a miniature crossed-beam apparatus was joined with Klempner's electric resonance spectrometer. This enabled quantum states of the reactively scattered CsF to be completely identified with respect to vibrational level, rotational angular momentum, and space orientation of the angular momentum. It also completed another link with the saga of Stern and Rabi.

### Beyond the Alkali Age

From the beginning, we spoke of the "early alkali age", a phrase both wistful and whimsical. It was intended to suggest that broader ages would inevitably follow, without predicting how soon. Skeptics discounted alkali reactions as an eccentric, unrepresentative family, but we gladly persisted because they revealed such instructive dynamical variety. Meanwhile, an unduly pessimistic view of prospects for beam studies of nonalkali reactions arose elsewhere. This came from attempts to use mass spectrometric detection which failed to reduce sufficiently the interfering background in the electron bombardment region. In March of 1967 we began designing a new apparatus, to be named *Hope*. Only nine months later it would take us "beyond the alkali age".

#### *Universal Detector and Supersonic Nozzles*

Hope was undertaken when Yuan Lee joined our group as a postdoctoral fellow. With Bruce Mahan at Berkeley, he had already built a major apparatus for beam studies of ion-molecule reactions. In this, as in Hope, he made elegant

use of ion counting techniques adapted from nuclear physics. Yuan was teamed with two beginning graduate students, Pierre LeBreton and Doug McDonald, and several machinists in our Departmental Shop, headed by George Pisiello. It was a group of extraordinary skill and zeal, inspired by Yuan's genius and fervent sense of mission. Blissfully, as each of the myriad design questions was settled, we all relished his verdict: "Should be all right".

The main features of Hope are shown in Fig. 15. The entire detector unit is mounted on a rotatable lid and the beam sources are fixed, to facilitate changing the source modules and strong pumping of the source chambers. The key component of the detector, the electron bombardment ionizer, is located within three nested chambers, each differentially pumped by ion pumps and cryogenic traps. This fulfills two vital design criteria for the ionization region. (1) The background gas (at the mass of interest) which diffuses in from the scattering chamber must be reduced to a partial pressure comparable to or lower than the product species which enters in free flight. This partial pressure is typically  $\sim 10^{-14}$  torr, only tenfold above the vacuum in interstellar space. (2) Background from deposit of product molecules on surfaces near the ionizer

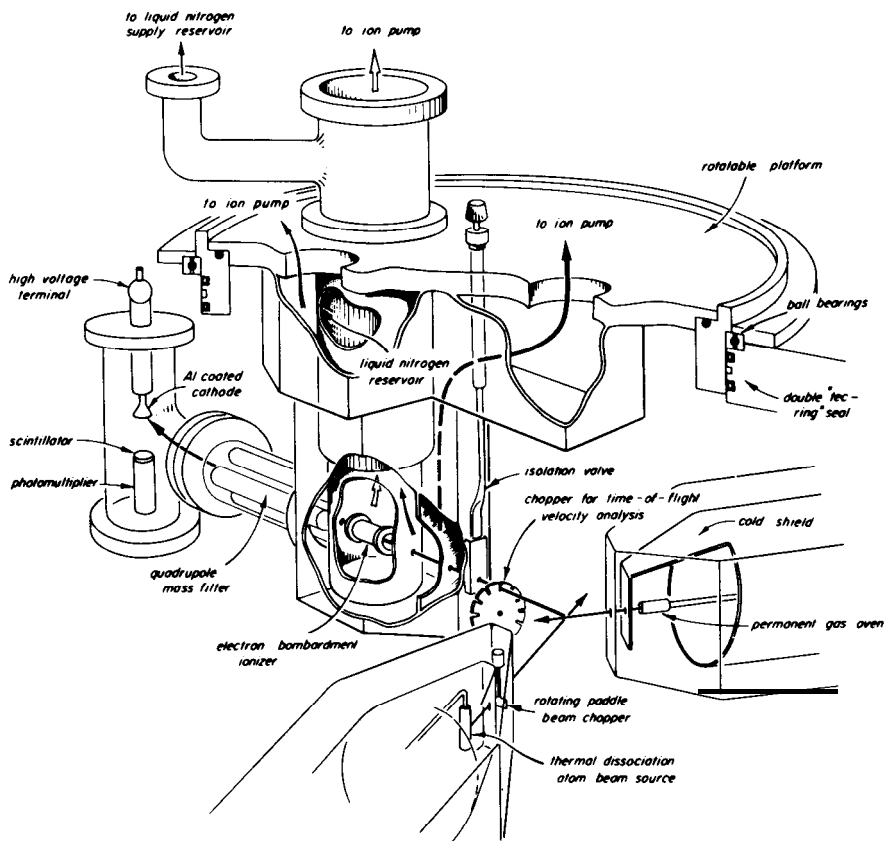

Fig. 15. Cutaway view of crossed beam apparatus *Hope* with mass spectrometric detector, showing beam geometry and arrangement of differential pumping for detector and source chambers.

must be avoided. This is accomplished by the nested design, which permits product molecules that pass through the ionizer without being ionized (the fate of 99.9%!) to fly on to another differentially pumped region before hitting a surface. In practice, Hope and its successors made accessible reactions with much smaller yields as well as greatly extending the chemical scope. Respectable reactive scattering data are now often obtained with product fluxes of only  $\sim 10^3$  molecules/sec.

Supersonic nozzles also greatly expanded the variety and scope of beam experiments. Beyond providing very high intensity (typically  $\sim 10^{18}$  molecules/steradian/sec), beams generated from such nozzles can be aptly viewed as a "new state of matter", with special properties much different from the old trinity of gas, liquid, and solid. The collisions occurring in the high pressure region of a supersonic nozzle organize the beam molecules to a remarkable extent. The exiting crowd of molecules may have mean separations of only 50 diameters, yet have nearly the same velocity and direction and hence suffer almost no collisions. Likewise, the temperatures associated with relative translation and rotation of molecules within the beam are typically very low (of the order of 1  $^{\circ}\text{K}$  or less) whereas the vibrational temperature can be kept high or made low by choice of conditions. Another option is translational acceleration by "seeding". The reactant gas is mixed with a large excess (typically 100-fold) of light diluent gas such as helium or hydrogen. Collisions during the supersonic expansion then bring the seeded molecules to the same exit velocity as the diluent gas, and also concentrate the heavier species along the beam axis. Intense beams are thereby obtained with kinetic energy readily variable over a wide range extending well above typical activation energies for chemical reactions.

Like many others since, our adoption of supersonic nozzles was spurred by John Fenn and Jim Anderson, ardent evangelists among the chemical engineers then exploring fluid flow in nozzles. Again, there was a cultural gap to be bridged; at a 1965 ecumenical meeting [12]:

"The engineers spoke only to one another about Reynolds numbers;

the chemists likewise talked just to each other about harpooning electrons."

The Kistiakowsky ax story also prompted us to try nozzles and indeed we had already used them in a modest way in alkali studies. Later we extended the scope of the seeding technique by a nozzle design suitable for solid or liquid substances, and others have developed many variants that have found wide application in both collision and spectroscopic experiments. The splinters from Kisty's ax sprouted into a bountiful garden.

#### *Recognizing Covalent and Ionic Cousins*

For our first experiments with Hope, we chose to study

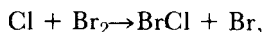

and other exchange reactions of halogen atoms and molecules. These were inviting because the reactant beams were easy to produce and all species could be very effectively pumped cryogenically. Furthermore, trihalogen complexes



had long been postulated as intermediates in the mechanism of halogen atom recombination and other processes. Such complexes had not been detected in the gas phase, and the only rate constants available for the exchange reactions had been derived from the always equivocal analysis of multistep processes in photochemical systems.

Our first attempt to study  $\text{Cl} + \text{Br}_2$  gave data of excellent quality and revealed instructive dynamical features. Although the total reaction cross section is  $\sim 10 \text{ \AA}^2$ , smaller than the hard-sphere cross section, the  $\text{BrCl}$  angular distribution peaks strongly in the forward hemisphere. This indicates that the dominant interaction is short-range and yet attractive. In previous beam experiments and trajectory calculations, the reactive scattering had always peaked backwards when the cross section was smaller than the hard-sphere value. However, despite its much smaller reaction cross section, the  $\text{Cl} + \text{Br}_2$  reaction gives product angle and translational energy distributions quite similar in form to the  $\text{K} + \text{Br}_2$  reaction. We suggested this was evidence for an osculating complex mechanism.

Only a few months after our results for  $\text{Cl} + \text{Br}_2$  were announced, groups at Freiburg and Los Alamos had confirmed our study, using mass spectrometric apparatus of appreciably different design. This illustrates the value of choosing an amenable system to test new apparatus or to extend an experimental domain. Yet the reaction cross sections found in the beam studies indicated that the rate constants derived from the photochemical experiments were about 100-fold too low. Later the photochemical studies were repeated, with results in agreement with the beam work.

In studies of other trihalogen systems, we obtained further evidence for an osculating complex with preferred reaction geometry. The wide-angle reactive scattering indicates complexes containing iodine are more stable than those with only bromine or chlorine, in accord with simple electronic structure arguments. Likewise, for complexes containing different atoms, the most stable configuration has the least electronegative atom in the central position. One of the striking results attributed to this preferred geometry appeared in the  $\text{Br} + \text{ClI}$  case. The yield of  $\text{BrCl}$  is about 5-fold smaller than otherwise expected and its angular distribution peaks backwards, indicating repulsive interaction. Subsequent studies, including variation of collision energy, brought out other dynamical features. Often these could also be interpreted by analogy to alkali reactions, despite the marked contrast in covalent and ionic bonding.

Next we pursued the reaction that John Polanyi had employed as the prototype in developing his infrared chemiluminescence method,

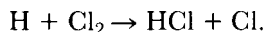

This system proved to have a gratifying kinship both to photodissociation of  $\text{Cl}_2$  and to the  $\text{K} + \text{CH}_3\text{I}$  reaction. Angle-velocity contour maps displaying this comparison are shown in Fig. 16. For the Polanyi reaction, the product angular distribution is broad but quite anisotropic, with the  $\text{HCl}$  recoiling backwards and  $\text{Cl}$  forwards with respect to the incident  $\text{H}$  atom. The product velocity is very high, about 1600 m/sec at the peak of the distribution. This corresponds to

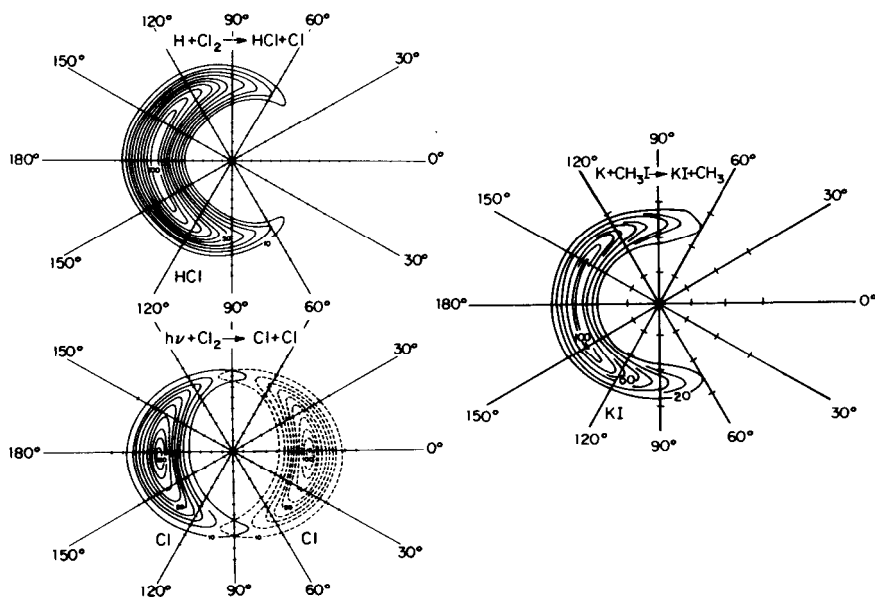

Fig. 16. Comparison of contour maps for photodissociation of the  $\text{Cl}_2$  molecule and for reactive scattering of  $\text{H} + \text{Cl}$ , and  $\text{K} + \text{CH}_3\text{I}$ . Map for the latter case from work of A.M. Rulis and R.B. Bernstein [3]. For each map, origin is at center-of-mass and horizontal axis is along reactant relative velocity vector, with direction of incident atom or photon designated  $\theta = 0^\circ$ . Tic marks along radial lines indicate velocity intervals of 200 m/sec.

release of about half of the available energy (reaction exoergicity of  $\sim 45$  kcal/mol plus initial collision energy of  $-10$  kcal/mol) in the translational recoil of  $\text{HCl}$  and  $\text{Cl}$ . The rest appears in vibrational and rotational excitation of  $\text{HCl}$ , which is observed in the infrared luminescence. The form of the angular distribution indicates collinear  $\text{H}-\text{Cl}-\text{Cl}$  as the preferred reaction geometry and the high recoil energy shows that strong repulsive forces are abruptly released.

The contour map for photodissociation was constructed from the continuous absorption spectrum of  $\text{Cl}_2$ , which shows directly the distribution of relative translational energy of the fragment  $\text{Cl}$  atoms and hence the repulsive energy release. The spectrum can be closely approximated by simply "reflecting" the Gaussian vibrational distribution of the ground electronic state from the steep ( $\sim 7$  eV/Å) repulsive wall of the dissociative excited electronic state. The angular distribution is governed by the dipole selection rule for absorption, which makes the transition probability vary as the square of the cosine of the angle between the  $\text{Cl}-\text{Cl}$  axis and the photon beam direction. We see that  $\text{H} + \text{Cl}_2$  and  $h\nu + \text{Cl}_2$  give remarkably similar angle-velocity maps.

More remarkable still is the close resemblance of  $\text{H} + \text{Cl}_2$  and  $\text{K} + \text{CH}_3\text{I}$ ; except for a change of scale, the contour maps are almost congruent. In terms of electronic structure, as already noted, the analogy to photodissociation is obvious in the  $\text{K} + \text{CH}_3\text{I}$  case because the harpooning electron enters the same strongly antibonding molecular orbital excited in photodissociation. In the  $\text{H} + \text{Cl}_2$  case the analogy is not obvious, since the very high ionization potential of



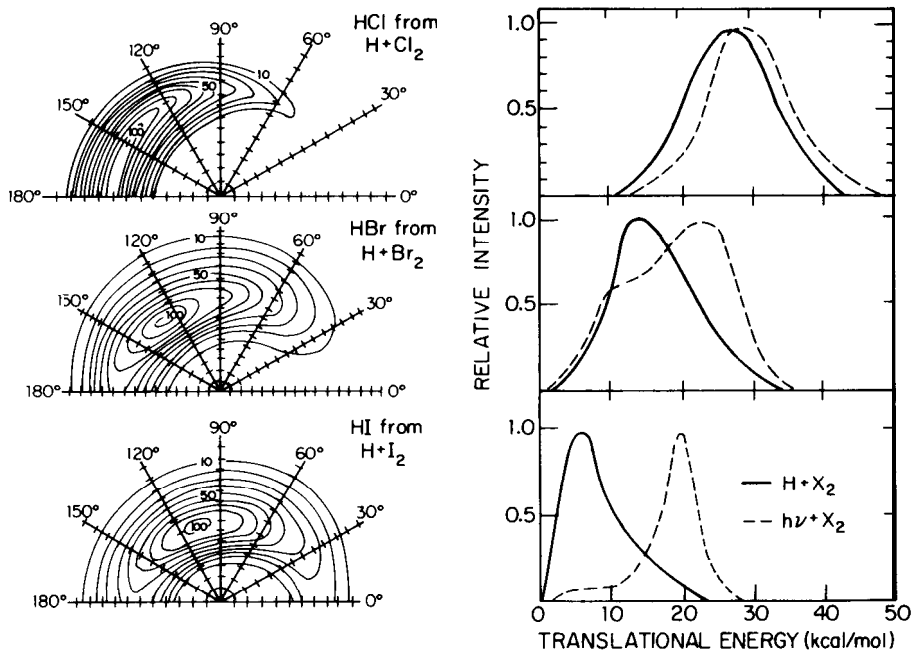

Fig. 18. Comparison of angle-velocity contour maps for reactions of H atoms with halogen molecules. Since maps must be symmetric with respect to the horizontal axis, only upper halves are shown. Tic marks along radial lines indicate velocity intervals of 200 m/sec for Cl<sub>2</sub> case, 100 m/sec for Br<sub>2</sub> and I<sub>2</sub>. Panels at right compare distributions of product relative translational energy (solid curves) with continuous absorption spectra of halogen molecules (dashed curves). Abscissa scales for spectra are shifted to place origin at the dissociation asymptote, and thus show directly the repulsive energy release in photodissociation.

The frontier node also shifts from about midway between the halogen atoms in H-Cl-Cl to close to the central atom in H-I-I. Many analogous stable molecules are known which have one more or one less valence electron than these H-X-X systems. The molecules with one more electron are linear or nearly so; those having one less electron are strongly bent, with bond angles of 90° to 110°. The shift of the frontier node might be expected to make H-I-I resemble a case with one less electron. Thus it is plausible that decreasing the halogen electronegativity fosters bent reaction geometry and reduces the repulsive energy release.

The H + ICl reaction is especially interesting. On an energetic or statistical basis, reaction at the "Cl-end" would be more favorable than at the "I-end", since the H-Cl bond strength (102 kcal/mol) is much larger than H-I (70 kcal/mol). The molecular orbitals suggest the H atom should prefer to attack the I-end, however. As a consequence of the electronegativity difference, in ICl both the highest occupied orbital ( $\pi^*$ ) and the lowest unoccupied orbital ( $\sigma^*$ ) are predominantly I atom orbitals. The beam studies find the HI yield is at least comparable to HCl and probably substantially higher (although the effect of some experimental factors that discriminate against HCl remains unresolved). The angular distribution of HI peaks sideways, the HCl backwards. The

infrared chemiluminescence detects only HCl and not HI, but this is compatible with the beam results because the dipole derivative of HI is exceptionally small and hence the infrared emission is very weak. The HCl energy distribution has a very unusual bimodal form. Comparison with trajectory calculations suggests that some of the HCl results from direct attack at the Cl-end, but most comes from indirect reaction after initial attack at the I-end. These two reaction modes produce HCl in low and high rotation-vibration states, respectively. Analogous steric preferences for many other reactions can likewise be attributed to *orbital asymmetry* arising from differences in electronegativity.

Further aspects of this theme were examined by studying reactions of oxygen atoms with halogen molecules. We found the reaction

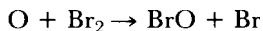

goes via a persistent complex with large yield and no activation energy. The product contour map shows prominent glory peaks. For other reactions with such maps, the intermediate complex usually corresponds to a stable molecular species which correlates with the ground-state reactants and products. Here, however, different spin states are involved. The reactants approach on a triplet surface, whereas the products can depart on either a singlet or triplet surface. The known stable  $\text{OBr}_2$  molecule has a symmetric, strongly bent geometry and a singlet ground state. Qualitative electronic structure arguments suggest that the reaction goes predominantly via a less stable, triplet O-Br-Br potential surface without transition to the more stable, singlet Br-O-Br surface. Likewise, the  $\text{O} + \text{ICl}$  reaction would be expected to give primarily  $\text{IO} + \text{Cl}$  rather than  $\text{ClO} + \text{I}$ , although the latter path is much more exoergic. We indeed found a large yield of IO but no detectable ClO, nice evidence that the reaction involves end-on attack rather than insertion. These results led us to the unorthodox prediction that the  $\text{O} + \text{F}_2$  reaction should prefer the F-O-F geometry rather than O-F-F, since oxygen is less electronegative than fluorine. This implies a relatively high activation energy, associated with the switch to an insertion mechanism, despite the large reaction exoergicity and the notorious chemical personalities of the reactants. Subsequent experiments [13] indeed confirmed that  $\text{O} + \text{F}_2$  is inhibited by a large activation energy.

#### *Migratory Atoms and Bonds*

With the mass spectrometric detector, we could now also proceed to "the organic age" and thereby pursue many further aspects of reaction dynamics. Particularly inviting were unimolecular reactions involving isomerizations or rearrangements. Fig. 19 shows the contour maps obtained for a favorite pair of examples, the displacement reactions of chlorine atoms with vinyl bromide and with allyl bromide. In these systems,



where R denotes  $\text{CH}_2=\text{CH}$  or  $\text{CH}_2=\text{CHCH}_2$ , respectively, the intermediate chlorobromoalkyl radical is a known, stable species. It is vibrationally excited by  $\sim 30$  kcal/mol, the sum of the initial collision energy and thermal excitation

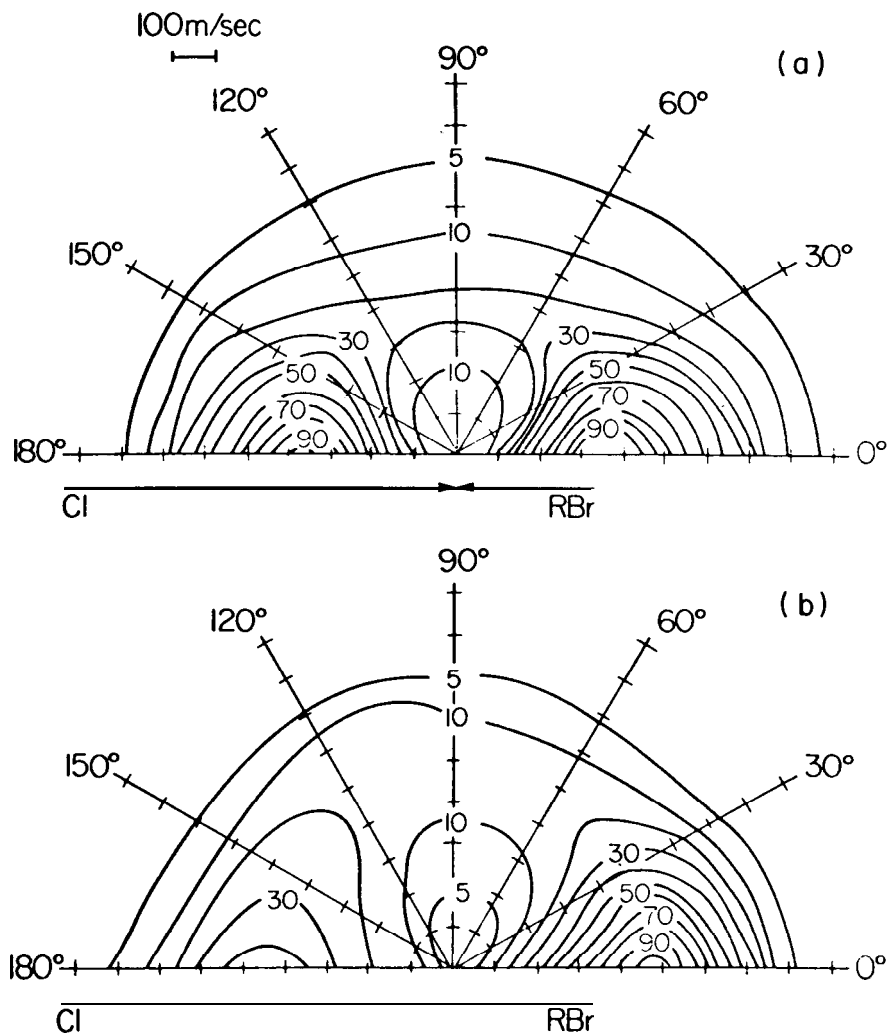

Fig. 19. Comparison of contour maps for chlorolefin products from reactions of chlorine atoms with (a) vinyl bromide and (b) allyl bromide. Tic marks along radial lines indicate velocity intervals of 100 m/sec.

of the reactant olefin, the loss in bond strength in converting the double bond to a single bond ( $\sim 57$  kcal/mol), and the gain in forming the new C-Cl bond (80 kcal/mol). Under our single-collision conditions, the excited radical cannot be deactivated by a subsequent collision and thus must undergo unimolecular decomposition. The net energy available to the products on reforming the double bond and releasing the Br atom is  $-19$  kcal/mol. These energetic aspects are the same for the vinylic and the allylic reactions.

The customary theory of unimolecular processes predicts that the allylic reaction should proceed more slowly and hence show more nearly statistical behavior, since it involves more atoms and therefore the excitation energy

shuffles among more vibrational modes than in the vinylic reaction. On the contrary, the contour map for the vinylic reaction indicates a persistent complex, that for the allylic reaction an osculating complex. Some special feature must intervene to make the vinylic reaction more nearly statistical than the allylic reaction. Indeed, this was anticipated in choosing these systems for study. According to a large body of work on organic reaction mechanisms, the initial stage in both reactions should involve addition of the Cl atom to the carbon atom "most distant" from that with the Br atom. As pictured in Fig. 20, this implies that a "free valence" appears on the carbon linked to Br in the vinylic case, but not in the allylic case. Thus, the vinylic reaction seems likely to proceed via a 1,2-chlorine *atom migration*, whereas the allylic reaction can go via a 1,3-*bond migration*. Since the heavy atom migration would be much slower than the bond migration, this might provide a rate-limiting process which makes the vinylic reaction more statistical than the allylic one.

These mechanisms require the product chlorolefin to have Cl on the carbon to which Br was originally bonded in the vinylic case, but to remain on the "most distant" carbon in the allylic case. We verified this by analysis of the fragment ion mass spectra of chlorolefins formed in corresponding reactions with a methyl group added to "label" one or another carbon atom. The methyl substitutions also produced revealing changes in the reactive scattering. For the vinylic cases, the angular distributions show variations which reflect changes in the rotational motions caused by the methyl group. For the allylic cases, the product translational energy distributions become statistical, as if the methyl group diverts the intramolecular energy flow and thereby makes it more random.

Further tests of the migration mechanisms were later obtained by Rowland using radioactive tracers [14]. In this work, the same vinylic and allylic reactions examined in the beam experiments were studied under "bulb" conditions. At low pressures, the products obtained were those expected for the atom- and bond-migration mechanisms, respectively. At high pressures, how-

#### Vinylic Reaction:

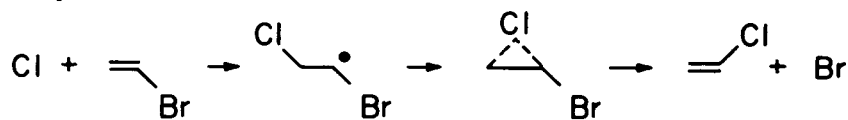

#### Allylic Reaction:

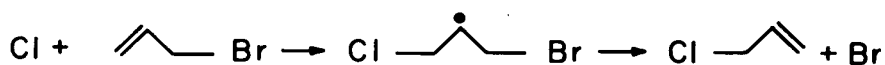

Fig. 20. Stereoselective mechanisms for 1,2-chlorine *atom migration* in vinylic reaction and 1,3-*bond migration* in allylic reaction.

ever, different products were obtained. These corresponded to the species expected from collisional stabilization of the intermediate chlorobromoalkyl radicals, followed by standard reactions of those radicals.

A host of other organic reactions have now been studied by beam methods, especially by Yuan Lee and his students. Often the intermediates and initial elementary steps have proven to be quite different than those postulated in conventional mechanistic studies. The wide range of bonding and stereochemical situations in organic systems ensures vast scope for dynamical detective work in this domain.

### Facile Molecular Reactions

The reaction systems discussed so far all involve attack by an open-shell atom or free radical. One of the chief criteria invoked in postulating elementary steps in reaction mechanisms is that only such processes have very low activation energies, less than 5 or 10 kcal/mol. The advent of the Woodward-Hoffmann rules focussed attention on reactions of molecules with molecules, which involve the concerted making and breaking of two or three pairs of bonds. These processes typically have activation energies above 20 kcal/mol when fully "allowed" by the rules and above about 40 kcal/mol when "forbidden." In this context, we sought instructive examples of facile bimolecular and termolecular reactions of diatomic molecules.

The simplest case is the exchange reaction of two alkali halides such as

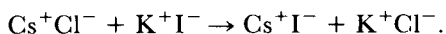

This might be termed a "no-electron" reaction, since the salt molecules are essentially closed-shell ion-pairs. Accordingly, no restraints are imposed by the molecular orbital correlations involved in the Woodward-Hoffmann rules. Yet a contemporary theoretical paper had concluded that even this alkali halide reaction would be subject to a high activation energy of -50 kcal/mol. This seemed unlikely in view of the strong long-range dipole-dipole attraction. Since alkali halides form rhombic quadrupolar dimers with dissociation energy ~30-50 kcal/mol, the potential surface for the exchange reaction has a deep basin. Our beam experiments indeed found the reaction proceeds via a persistent complex. There is no activation energy and the reaction cross section is extremely large, corresponding to formation of the complex in collisions with impact parameters up to ~8-9 Å. We therefore spoke of a "vacuum cleaner" potential. The product angle and velocity distributions conform nicely to the usual statistical model, but the ratio of nonreactive to reactive decay of the complex was 2 or 3 times larger than statistical. As in the analogous atom + salt case, this can be attributed to geometrical isomerism. Ionic model calculations predict less stable, linear chain isomers exist in addition to the rhombic dimer. These linear chain isomers may often dissociate nonreactively rather than rearrange to the cyclic form required for the exchange process, especially when the centrifugal angular momentum in the collision keeps the chain "ends" apart. It is like two pairs of ice skaters playing "crack the whip."



Extensive trajectory calculations by Brumer and Karplus confirmed this striking role of geometrical isomerism.

Since the four-center ionic + ionic reaction proved facile whereas the typical covalent + covalent case was forbidden according to Hoffmann's orbital correlations, we examined several reactions involving ionic + covalent reactions. These also proved facile at thermal collision energies; for example,

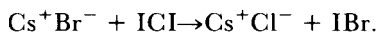

This reaction very likely involves formation of an alkali trihalide salt,  $\text{Cs}^+(\text{BrICI})$ , and charge migration within the trihalide anion. Although apparently unknown in the gas phase, trihalides have been much studied in solution and in the solid state. In agreement with molecular orbital theory, the trihalide anions are linear or nearly linear, the middle atom is always the least electronegative (I, in this case) and it acquires a small positive charge whereas the end atoms share the negative charge. Clear evidence for this structure appears in the reactive scattering. There is no observable yield of  $\text{Cs}^+\text{I} + \text{BrCl}$ , even at collision energies more than 20 kcal/mol above the energetic threshold for this channel. Furthermore, as seen in Fig. 21, the IBr angle-velocity contour map has a very unusual skewed shape. The lefthand product peak has distinctly higher intensity and velocity than the righthand peak. This shows that collisions from which IBr and CsCl rebound backwards with respect to the incident ICl and CsBr, respectively, are more probable and involve more repulsive energy release than collisions from which IBr and CsCl emerge in the same direction as the incident ICl and CsBr, respectively. These properties are

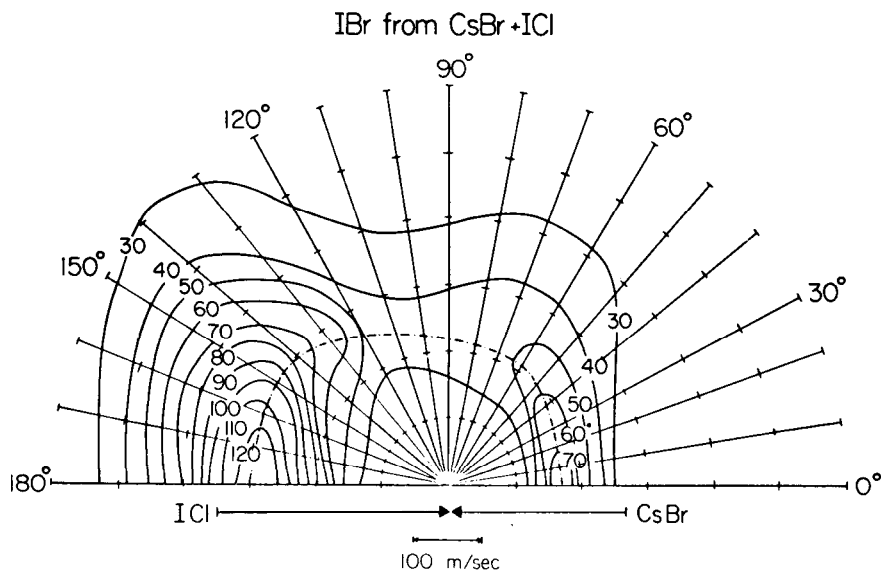
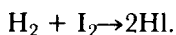

Fig. 21. Contour map of IBr product distribution from CsBr + ICl reaction at collision energy of 3.9 kcal/mol.

consistent with the expectation that in  $\text{Cs}^+\text{Br} + \text{ICl}$  reactive configurations,  $\text{Br}$  tends to be collinear with  $\text{ICl}$  while  $\text{Cs}^+$  is likely to collide with the central  $\text{I}$  atom. The positive charge acquired by  $\text{I}$  as the trihalide forms then repels  $\text{Cs}^+$ , which picks up the emerging  $\text{Cl}$  and departs quickly in the direction opposite to the incident salt. Similar ionic + covalent reactions such as  $\text{CsF} + \text{HCl}$  and  $\text{NaO} + \text{HCl}$  [15] likewise go with near zero activation energy.

In the domain of four-center covalent + covalent reactions, the landmark is the classic work of Sullivan on the favorite "textbook" case,



In 1967 he showed this does not occur as a four-center reaction but involves dissociation or near-dissociation of  $\text{I}_2$  followed by  $\text{I} + \text{H}_2 + \text{I}$ . Soon after, Jaffe and Anderson studied  $\text{HI} + \text{DI}$  using the seeded supersonic beam technique and found no detectable  $\text{HD}$  yield at collision energies far above the empirical activation energy. This is certainly an allowed reaction, at least as the reverse of  $\text{I} + \text{HD} + \text{I}$ , but apparently vibrational rather than translational activation is required. Likewise, in our laboratory David Dixon and David King found no evidence for the four-center exchange reaction

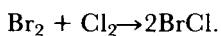

Their experiment employed two supersonic nozzles and scanned the collision energy up to  $\sim 25$  kcal/mol. Formation of  $\text{BrCl}$  is readily observed on mixing the reactants in a bulb, and rate studies had indicated a relatively low activation energy, only  $\sim 15$  kcal/mol. However, this was suspect because of "possible catalysis by moisture or surfaces," a traditional lament in kinetic studies. Hoffmann's molecular orbital correlation diagram predicts a much larger activation barrier, comparable to the promotion energy of two electrons from a bonding to an antibonding orbital and thus above the dissociation energy of the weaker reactant bond 45 kcal/mol.

Since a six-center, termolecular reaction is allowed by the orbital correlations, we decided to look for

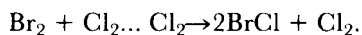

Scattering experiments using three crossed beams are utterly impractical, but appreciable fluxes of reactant dimer molecules, linked by a weak van der Waals bond, can readily be generated by a supersonic expansion. We were encouraged by tantalizing evidence obtained by Noyes for a third order reaction of halogen molecules in solution. Yet analogy to other allowed six-center cases (such as Diels-Alder reactions) suggested that the activation barrier might well be  $\sim 20$  kcal/mol, and it might also require chiefly vibrational rather than translational excitation. Thus, we were startled when King and Dixon found large yields of  $\text{BrCl}$  that appeared to come from the termolecular process even at thermal collision energies of only  $\sim 3$  kcal/mol. However, velocity analysis data for this system and the analogous  $\text{HI}$  reaction provided several kinematic consistency tests which even indicated that three sequential bond scissions can be resolved in the termolecular exchange process. Soon another example of a

facile molecular reaction fostered by a van der Waals dimer was provided by Durana and McDonald [16]. They found that  $F_2 + (HI)_2$  yields intense HF infrared chemiluminescence whereas  $F_2 + HI$  gives none. Whether or not these processes actually involve six-center transition-states, the weak van der Waals link is remarkably effective in promoting a reaction that otherwise does not go.

Subsequently, we undertook potential surface calculations to examine termolecular six-center bond exchange processes. For  $Cl_6$  a traditional semiempirical treatment [17] indicates facile reaction but the approximations involved are dubious. For hexagonal  $H_6$  *ab initio* calculations of high quality were carried out by Dixon and Stevens [18] and show that a termolecular path is indeed accessible without breaking an H-H bond whereas there appears to be no such path for a bimolecular, four-center exchange. The results for  $H_4$  and  $H_6$  thus conform to the rule, amply demonstrated in organic chemistry, that cycloaddition reactions involving  $4m$  electrons are forbidden as concerted processes while those involving  $4m + 2$  electrons are allowed. But it turns out that  $H_6$  obeys this rule only through configuration interaction, not by virtue of the usually invoked nodal properties.

The special role of  $H_6$  was elucidated further by comparison with several previous calculations for larger  $H_n$  polygons, available for  $n = 4m + 2$  extending from  $n = 14$  to 62. These calculations, pertinent to model treatments of metallic hydrogen, found the bond length and cohesive energy (binding per atom) to be nearly constant for the whole series. Since our values for  $H_6$  proved to be practically the same, we can reliably estimate the stability of  $H_{10}$  and higher polygons by taking the cohesive energy as constant. This shows that  $H_6$  is the only  $H_{4m+2}$  polygon that is stable with respect to dissociation of an  $H_2$  bond and hence the only polygon that can serve as transition-state for a concerted bond exchange. The customary orbital symmetry criterion thus fails for all the higher  $4m + 2$  polygons; it must be supplemented by an energetic criterion in order to predict whether a reaction is concerted.

The unique stability of  $H_6$  relative to dissociation of an  $H_2$  bond also suggests that solid molecular hydrogen might undergo a high pressure transition to form a new phase involving termolecular complexes before transition to the long-sought atomic or metallic phase (predicted in 1948 by Wigner). This possibility was examined by Rich LeSar by means of lattice-energy calculations employing approximate pair potentials [19]. Although uncertainties in the potentials prevent a definite conclusion, the results obtained for a range of parameters indicate that a phase comprising a "partly dissociated" form of the six-center transition state may be stable at pressures above a few hundred kilobars. As shown in Fig. 22, repulsive forces from the neighboring units in the crystal prevent dissociation of this complex to diatoms. A marked drop in the  $H_2$  stretching frequency observed at high pressure is qualitatively consistent with formation of molecular clusters but by no means a clear test. In any case, these calculations serve to illustrate how pursuit of reaction dynamics can lead to far distant domains!

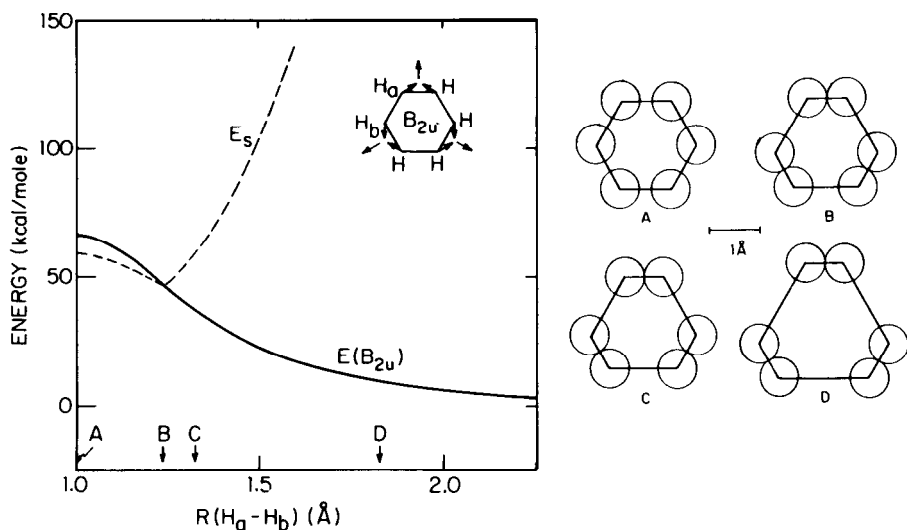

Fig. 22. Potential energy profile for dissociation of a hexagonal  $H_6$  complex in free space (solid curve) and in a hexagonal closest-packed crystal (dashed curve, computed for pressure of 400 kbar) in which repulsive interactions with neighbors prevent the dissociation. At right are shown configurations of the thermolecular complexes corresponding to positions marked along abscissa. The circles for each H atom have a radius of half of the free  $H_2$  bond length.

### Van der Waals Dimers and Clusters

Supersonic expansions make accessible a vast range of species and processes involving feeble bonds. In effect, the very low internal temperatures in supersonic beams circumvent the Second Law, since the entropy term in the free energy,  $\Delta H - T\Delta S$ , can be made negligible. Even a weakly favorable enthalpy term then suffices to produce large yields of dimers or bigger clusters. This permits studies involving "solvation" of reactant species and other interactions akin to condensed phase or surface chemistry. In the past few years such work has created a major new field, with particular emphasis on metal clusters [20]. Here we describe some of our experiments to illustrate a few favorite themes.

In solution kinetics, much attention has been devoted to photodissociation and recombination processes. These are usually interpreted in terms of "the cage effect," in which the solvent inhibits diffusive separations of the photofragments. A different perspective has now emerged from beam experiments [21]. Complexes of  $I_2$  with various solvent species such as Ar,  $N_2$ , benzene, . . . were formed by supersonic expansion and excited with a laser in a spectral region above the dissociation threshold for the bare  $I_2$  molecule. This produced intense fluorescence, showing that instead of dissociating much of the iodine relaxes into bound vibrational levels of the electronically excited B state. Energy balance is maintained by breaking the van der Waals bond(s) of the original solvent complex and releasing some repulsion into relative translation of the product fragments. In solution photodissociation must likewise be mollified by energy transfer to the solvent and the surviving excited iodine molecules may account for features previously attributed to recombination of caged atoms.

Another typical role of solvation is exemplified in reactions of ammonia clusters with hydrogen halides. For unclustered ammonia proton transfer is endoergic to form the ionic salt,  $\text{NH}_3^+\text{X}^-$ , increasingly so for  $\text{X} = \text{I} \rightarrow \text{Br} \rightarrow \text{Cl}$ . In crossed-beam scattering with clustered ammonia, new mass peaks appear that correspond to  $(\text{NH}_3)_n\text{HX}$  adducts with  $n$  as large as 15 or more. Fragmentation of these peaks appears to decrease markedly on completion of the first solvation shell. For sufficiently large clusters the complex formation probably involves proton transfer and is driven by solvation of the resulting  $\text{NH}_3^+\text{X}^-$  ion pair by the "extra" ammonia molecules in the reactant cluster.

Although solvated ions govern a host of solution phenomena, the individual molecular species and processes often cannot be resolved or characterized in condensed phases. Thus studies of molecular cluster ions in the gas phase have become another major field; for instance, the elusive hydrated electron has now been produced in beams of unfragmented water clusters [22]. In related work, we studied collisional electron transfer from alkali atoms to molecular clusters. Since the process is endoergic, fast atoms are generated from a seeded supersonic expansion. Because the electron transfer can only occur within the crossing radius for the ionic-covalent potential curves, the time-scale becomes very short, typically  $\sim 0.3$  psec. This limits use of the method for electron affinity studies but also provides a means to probe the size of cluster subunits involved in impulsive interactions [23].

For small clusters, particularly dimers, it is feasible to study the exchange of van der Waals bonds by the same methods employed for chemical bonds. Fig. 23 shows an angle-velocity contour map obtained by Worsnop and Buelow [24] for the  $\text{Xe} + \text{Ar}_2$  reaction. Since thermal collision energies are typically several times larger than the dimer well depth, conservation of energy and momentum constrain the scattered diatom product to a narrow circular band centered on the center-of-mass velocity; only within that band can  $\text{XeAr}$  be formed with low enough internal excitation to hang together. However, several other fea-

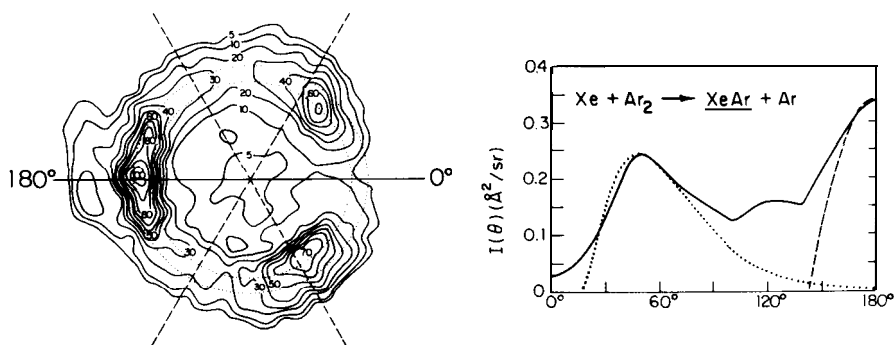

Fig. 23. Contour map for  $\text{XeAr}$  from  $\text{Xe} + \text{Ar}_2$  reaction at collision energy of 1.3 kcal/mol. The dotted circular band shows the kinematically allowed scattering region for nominal parent beam velocities. At right angular distribution derived from experimental map (solid curve) is compared with predictions from the hard-sphere model, including *knock-out* (dashed curve) and *sequential impulse* (dotted curve) contributions.

tures provide dynamical information. These include the pronounced "hole" in the reactive scattering in the forward direction, which is accompanied by strong peaking near  $50^\circ$ , and an even stronger backward scattering.

This pattern is remarkably similar to that found for some ion-molecule reactions, such as the  $O^+ + HD \rightarrow OH^+ + D$  reaction, for which the collision energies and bond strengths are more than 100-fold higher. As illustrated in Fig. 23, we find several properties are in nearly quantitative agreement with an impulsive model based on pairwise hard sphere interactions. Two distinct collision modes give the chief contributions. In the mode that accounts for the forward pitched scattering, A + BC interact via *sequential* hard sphere elastic collisions (A off B, then B off C); the exchange reaction occurs only when the final relative velocity of A and B corresponds to an energy less than the AB bond strength. For this mode, the angular distribution may be found from a geometric construction devised by Mahan for high energy ion-molecule reactions [25]. The other mode gives strong backward scattering by a process familiar in billiards; A *knocks-out* B and thereby comes nearly to rest with respect to the C atom, so the resulting AC molecule moves briskly backward with respect to the center-of-mass. This study of an exchange of feeble bonds thus helped develop a more comprehensive asymptotic model applicable to any atom transfer reaction when the ratio of collision energy to bond strength becomes large.

### Pursuit of Vector Correlations

In addition to the product angular distribution, many other directional or vector properties of reactions are now accessible in beam experiments, especially by means of laser-induced fluorescence techniques developed by Zare which exploit the orientation dependence of the dipole selection rule for electronic excitation [26]. These vector properties offer much information not provided by energetic or other scalar properties, and their study is now emerging as a vigorous field referred to as dynamical stereochemistry or *stereodynamics*. For instance, as indicated in Fig. 24, of special interest is the *triple-vector correlation* among the initial and final relative velocities and the product rotational angular momentum. In principle, this vector correlation offers a means to undo the "dart-board" averaging over the random azimuthal orientations of initial impact parameters. The distributions of both  $\mathbf{k}'$  and  $\mathbf{j}'$  must have azimuthal symmetry about  $\mathbf{k}$ , but when a subset is selected of  $\mathbf{k}'$  vectors with particular  $\mathbf{j}'$  (or vice-versa), this subset in general will not have azimuthal symmetry about  $\mathbf{k}$ . Model calculations and an early electric deflection study by Hsu and McClelland of the  $Cs + CH_3I$  reaction revealed marked asymmetry; as the freshly formed CsI recoils from the collision, its internuclear axis tends to rotate in or near the plane of the initial and final relative velocity vectors. Far more detailed information of this kind is in prospect from studies using laser-induced fluorescence, especially since the great sensitivity of the method may allow the alignment of individual rotaton-vibration states to be measured as a function of the scattering angle.

We may even be optimistic about measuring some properties of the four

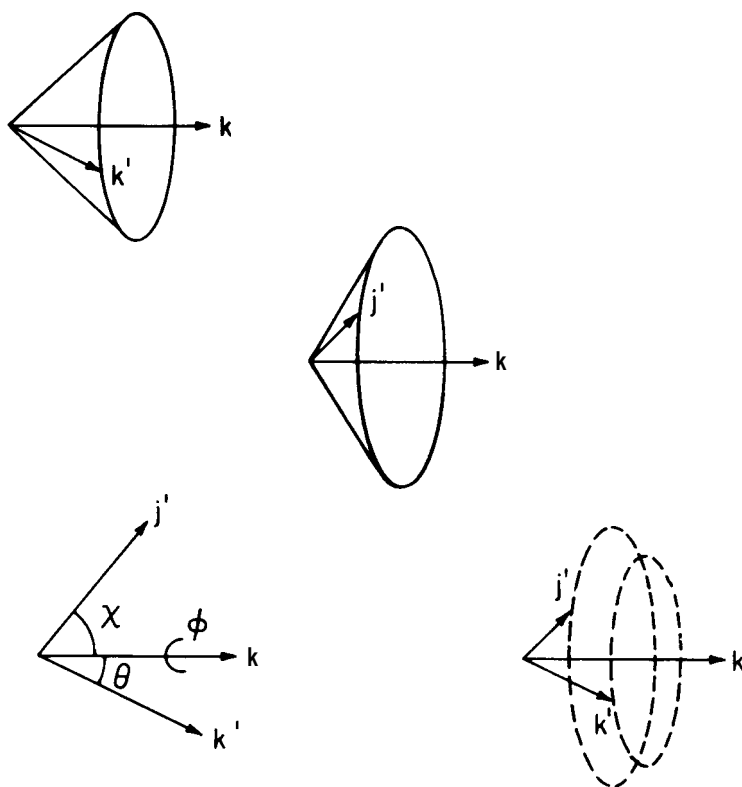

Fig. 24. Three-vector correlation among initial and final relative velocity vectors, here denoted by  $\mathbf{k}$  and  $\mathbf{k}'$ , and product rotational angular momentum vector  $\mathbf{j}'$ . Upper pair of diagrams indicate the azimuthal symmetry about  $\mathbf{k}$  of the  $\mathbf{k}'$  and  $\mathbf{j}'$  product vectors inherent when these are observed separately, as in the two-vector correlations  $(\mathbf{k}, \mathbf{k}')$  and  $(\mathbf{k}, \mathbf{j}')$ . Lower pair of diagrams indicates how the three-vector correlation  $(\mathbf{k}, \mathbf{k}', \mathbf{j}')$  can give information about the dihedral angle  $\phi$ , in effect undoing the azimuthal averaging about the initial velocity.

vector correlation involving both the velocity vectors and the reactant as well as product rotation. This correlation of course contains still more information than found in the six two-vector and four three-vector correlations involving pairs or triads of the four vectors. As exhibited in a model calculation [27], such information includes the azimuthal asymmetry with respect to both  $\mathbf{k}$  and  $\mathbf{k}'$ , the preferred rotational orientation of both the reactant and product molecules with respect to the  $\mathbf{k}$ ,  $\mathbf{k}'$  plane, and even the relative sense of rotation (parallel or contrary). Several averages implicit in lower order vector correlations are thus undone. The loss of information otherwise imposed by the random aspects of the initial conditions resembles the celebrated "phase problem" encountered in X-ray scattering. Thus the complications required to unravel phases for a molecular structure determination are heuristically analogous to undoing impact parameter averaging by observing one or two "extra angles" in collision experiments. In such ways, a further level of molecular resolution awaits reaction dynamics.

## ACKNOWLEDGEMENTS

This paper is a tour through a family album. The frequent mentions of work by "we" pertain to my colleagues listed in Table 1 a roster of 51 graduate students and 35 postdoctoral fellows (in *italics*) listed in order of their "graduation" from our research group. Their work totals about 250 years of research, 150 of that in reaction dynamics. The investment of human resources is far greater, however. Beyond the direct contributions by the machine shop and other staff, all of us received vital help along the way from our teachers, our relatives, and many friends and colleagues. Sustained financial support was likewise vital, including many scholarship and fellowship awards as well as research grants from several agencies, especially the National Science Foundation. To all who made our research possible, I am deeply grateful.

In revisiting the album, I have lingered fondly on the early episodes because, as in dynamics generally, the initial conditions are often as important as the force field. I hope that students and young researchers starting their own work might be encouraged to see how simple and naive were our first steps. I hope also that some research administrators and funding agencies might be encouraged to take a longer-range view of quixotic projects. In our work the essential impetus was the evangelical fervor of young scientists captivated by new vistas. But to pursue such distant vistas we have freedom and support. In many quarters this seems less forthcoming today. In expressing thanks for our good fortune, I must urge renewed efforts to foster enterprising work on fundamental problems.

The family album contains far more than shown here, including many intriguing chapters from other laboratories. Again I recommend an admirable pair of texts [3] which survey much work deserving of honor at this forum. Over 30 years of reaction dynamics, the fellowship of striving and joy of discovery have created an intense sense of community. Perhaps in emulation of our molecular friends, recruits to this field seem unusually excitable, zestful, and generous. Working in such a community in pursuit of new insights is a splendid prize, enhanced in the sharing. Thereby we offer thanks for the privilege of studying our ever mysterious atoms and molecules.

Table 1. Roster of Graduate Students and Postdoctoral Fellows

Vintage	Alumni
'62	<i>J.L. Kinsey, M.S. Child</i>
'63	J.A. Norris, P.R. Brooks
'64	R.N. Zare, K.R. Wilson, <i>M.A.D. Fluendy, R.J. McNeal</i>
'65	<i>M.C. Moulton, R.J. Cross, R.R. Herm, R.M. Martin, J. Chrysochoos</i>
'66	<i>J.H. Birely, E.A. Gislason, M. Cosandey, J.R. Jordan, A. Niehaus</i>
'67	G.H. Kwei, R. Grice, E.A. Entremann, <i>H.D. Cohen, P.M. Strudler, P.B. Empedocles</i>
'68	W.C. Stwalley, R.W. Anderson, <i>Y.T. Lee, Ch. Ottinger, G.A. Fisk, J.F. Wilson, V. Aquilanti</i>
'69	S.A. Safron, W.B. Miller, P.E. Siska, H.L. Kramer, C. Maltz, <i>T. Kitagawa</i>
'70	P.R. LeBreton, R.J. Gordon, S.J. Riley, R.H. Harris, S.M. Freund, <i>K. Lacmann</i>
'71	J.U. McDonald, <i>R.M. Düren</i>



- '72 N.D. Weinstein, S.A. Adelman, W.S. Struve, *H.J. Loesch*  
'73 R.P. Mariella, *D.L. McFadden, D.D. Parrish, J.R. Krenos*  
'74 D.L. King, D.S.Y. Hsu, J.T. Cheung, R.A. Larsen, D.M. Lindsay, P.E. McNamee  
'75 S.K. Neoh, D.A. Dixon  
'76 D.A. Case, *R.A. Sanders*  
'77 K.H. Bowen  
'78 L.D. Trowbridge, *G. W. Liesgang, J.J. Valentini*  
'79 G.M. McClelland, *W. Lee*  
'80 E.L. Quitevis, *R. Naaman*  
'81 K.L. Saenger, R.A. Lesar, *N. Agmon, O. Cheshnovsky*  
'82 D.R. Worsnop, *S. Raynor, A. Yokozeki*  
'83 S.J. Buelow, J.D. Barnwell  
'84 J.G. Loeser, *C.J. Sandroff*  
'86 M.R. Zakin, D.J. Doren, D.Z. Goodson, *S.G. Grubb*
- 

## REFERENCES

- [1] H.S. Johnston, *Gas Phase Reaction Rate Theory*, Ronald Press, New York, 1966.  
[2] For most of the work described here, references to the original literature may be obtained readily from a few reviews. Early chemical applications are discussed by S. Datz and E.H. Taylor, in *Recent Research in Molecular Beams*, I. Estermann, Ed., Academic Press, New York, 1959. We have surveyed the development of our studies and allied work in: *Disc. Faraday Soc.* 33, 149 (1962); *App. Optics Suppl. (Chemical Lasers)*, 128 (1965); *Adv. Chem. Phys.* 10, 319 (1966); *Faraday Disc. Chem. Soc.* 55, 233 (1973); *Pure and Applied Chem.* 47, 61 (1976). Usually we will omit specific citation except for papers not referenced in these reviews.  
[3] R.B. Bernstein, *Chemical Dynamics via Molecular Beam and Laser Techniques*, Clarendon Press, Oxford, 1982; R.D. Levine and R.B. Bernstein, *Molecular Reaction Dynamics*, 2nd Ed., Oxford University Press, New York, 1987.  
[4] Of course, these are not Stern's exact words, although my memory of him is vivid. I have presented his stories in first person as an attempt to capture his way of telling them.  
[5] W. Klemperer and D.R. Herschbach, *Proc. Natl. Acad. Sci. (U.S.)* 43, 429 (1957). The response to vibrational excitation was shown by K.T. Gillen and R.B. Bernstein, *Chem. Phys. Letts.* 5, 275 (1970).  
[6] This had been published about a year before but somehow I had missed seeing that issue of the *Journal of Chemical Physics*. In the same volume I also found an exceptional paper on transition-state theory by another author new to me: J.C. Polanyi!  
[7] The Pickwickian phrase is a typically Polanyian comment by John, delivered when he and his father Michael visited the Society of Fellows in 1966.  
[8] G.B. Kistiakowsky and W.P. Slichter, *Rev. Sci. Inst.* 22, 333 (1951).  
[9] R.N. Zare and D.R. Herschbach, *Proc. I.E.E.E.* 51, 173 (1963); R.N. Zare, *Mol. Photochem.* 4, 1 (1972); C.H. Greene and R.N. Zare, *Ann. Rev. Phys. Chem.* 33, 119 (1982).  
[10] D.R. Herschbach, *J. Phys. Chem.* 83, 4A (1979).  
[11] K. Lacmann and D.R. Herschbach, *Chem. Phys. Letts.* 6, 106 (1970).  
[12] C.E. Kolb and D.R. Herschbach, *J. Phys. Chem.* 88, 4447 (1984).  
[13] R.H. Krech, G.J. Diebold, and D.L. McFadden, *J. Am. Chem. Soc.* 99, 4605 (1977).  
[14] R.S. Iyer and F.S. Rowland, *Chem. Phys. Letts* 103, 213 (1983). See also *Faraday Disc. Chem. Soc.* 67,250 (1979). See also *J. Phys. Chem.* 89,2042,3730 (1985) for evidence suggesting less stereospecific addition as well as Br atom migration.

- [15] J.A. Silver and C.E. Kolb, *J. Phys. Chem.* 90, 3267 (1986).
- [16] J.F. Durana and J.D. McDonald, *J. Am. Chem. Soc.* 98, 1289 (1976).
- [17] D.A. Dixon and D.R. Herschbach, *Faraday Disc. Chem. Soc.* 62, 162 (1977);  
D.L. Thompson and H.H. Suzukawa, *J. Am. Chem. Soc.* 99,3614 (1977).
- [18] D.A. Dixon, R.M. Stevens, and D.R. Herschbach, *Faraday Disc. Chem. Soc.* 62,  
110 (1977).
- [19] R. LeSar and D.R. Herschbach, *J. Phys. Chem.* 85,3787 (1981).
- [20] See, for example, F. Trager and G. zu Putliz, Eds., *Metal Clusters*, *Z. f. Phys. D* 3  
(1986).
- [21] K.L. Saenger, G.M. McClelland, and D.R. Herschbach. *J. Phys. Chem.* 85,3333  
(1981); J.J. Valentini and J.B. Cross, *J. Chem. Phys.* 77,572 (1982).
- [22] H.Haberlund, H.-G. Schindler, and D.R. Worsnop, *J. Phys. Chem.* 88, 390  
(1984).
- [23] K.H. Bowen G.W. Liesegang, B.S. Sanders and D.R. Herschbach, *J. Phys.  
Chem.* 87,557 (1983).
- [24] D.R. Worsnop, S.J. Buelow, and D.R. Herschbach, *J. Phys. Chem.* 90, 5121  
(1986).
- [25] B.H. Mahan, W.E.W. Ruska, and J.S. Winn, *J. Chem. Phys.* 65, 3888 (1976).
- [26] D.A. Case, G.M. McClelland, and D.R. Herschbach, *Mol. Phys.* 35,541 (1978).
- [27] J.D. Barnwell, J.G. Loeser, and D.R. Herschbach. *J. Phys. Chem.* 87, 2781  
(1983).