

# Controlling photons in a box and exploring the quantum to classical boundary



COLLÈGE  
DE FRANCE  
—1530—

Serge Haroche



# Thought experiments

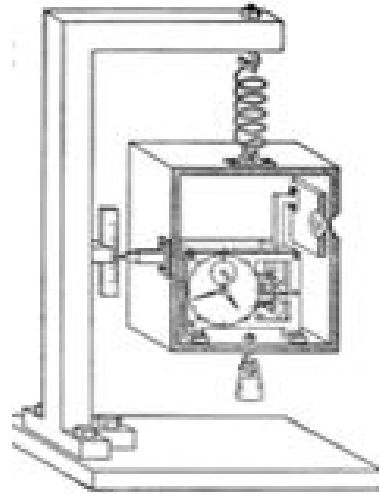
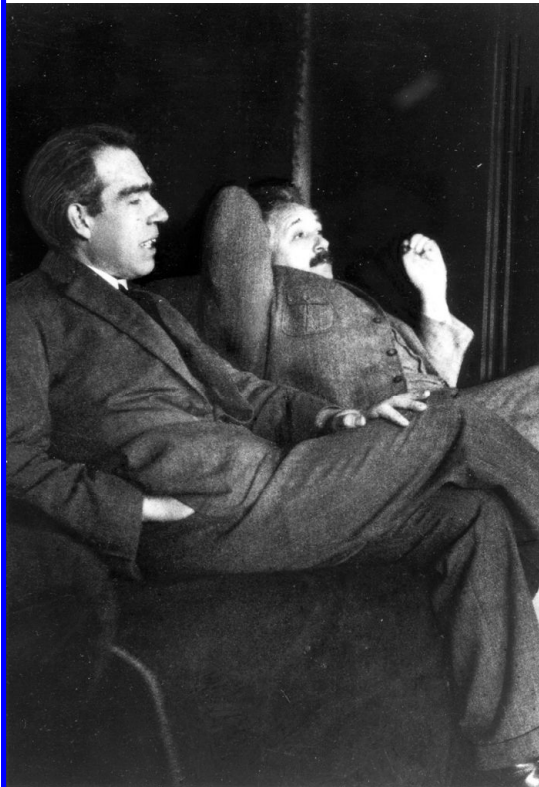

Einstein, Bohr and their Photon Box...  
a kind of experiment that  
Schrödinger considered impossible  
to realize....

Single particle detection was known to Schrödinger, but, as he put it, it was « *post mortem* » physics, destroying the object under investigation...

Bubble chamber  
(CERN)

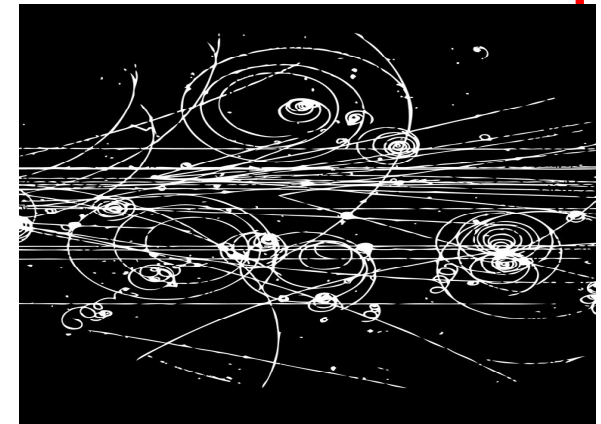

"...It is fair to state that we are not experimenting with single particles, any more than we can raise *Ichthyosauria* in the zoo. We are scrutinising records of events long after they have happened." (Schrödinger, 1952)

# How "thought experiments" controlling a zoo of particles became real

New quantum technologies:

Tunable lasers

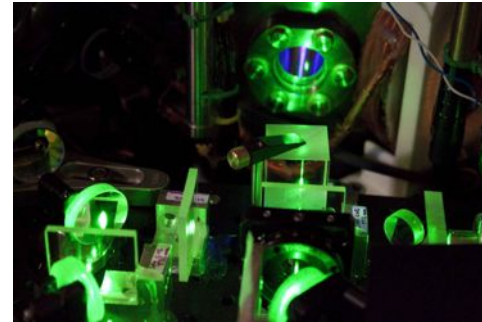

Fast computers



Superconducting  
materials



# «Particle control in a quantum world»

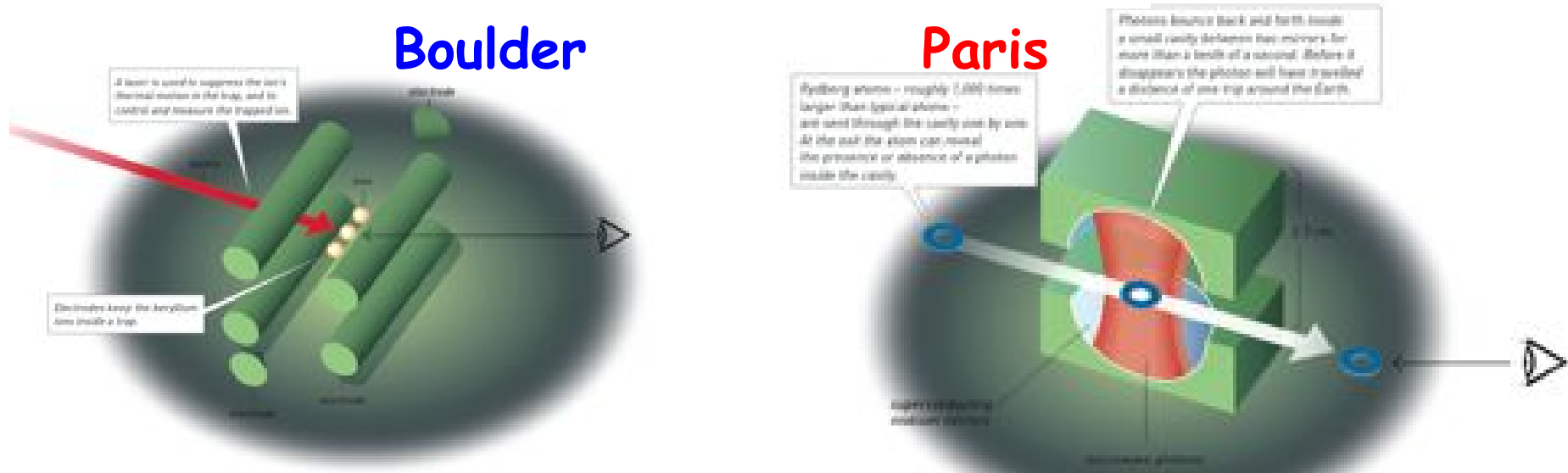

Two sides of the same coin: manipulating non destructively  
 single atom with photons or single photon with atoms

Trapped photons  
 (CQED):  
 Brune et al,  
 PRL, 76, 1800  
 (1996)

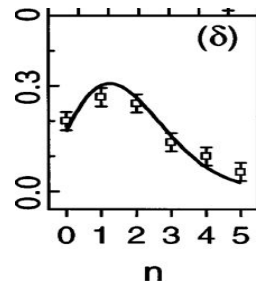
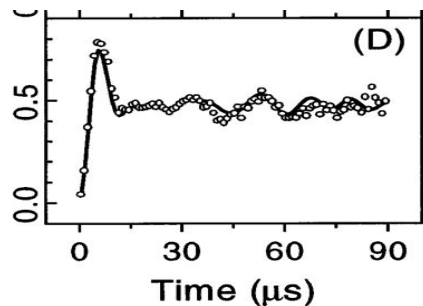

Trapped ions:  
 Meekhof et al,  
 PRL, 76, 1796  
 (1996).

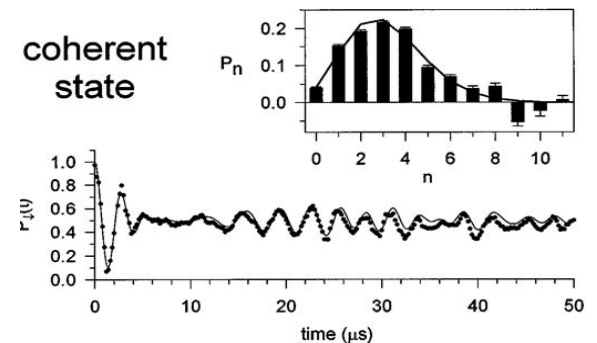



**Boboli Gardens, Florence (August 1996)**



PhD with Claude Cohen-Tannoudji (1967-71)

Optical pumping experiments &  
Dressed atom formalism



1997



Postdoc with Arthur Schawlow (1972-73)

Quantum beats excited by dye lasers  
(time evolution of  
state superpositions)



1981

(1921-1999)

# ...but the story really started with the first studies of Rydberg atom masers in the late 1970's

M. Gross, C. Fabre, S. Haroche, J.M. Raimond, PRL 43, 343 (79)

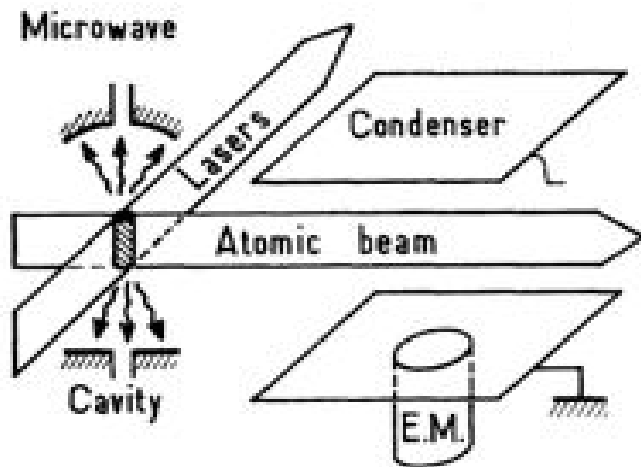

Open cavity

An insightful comment...and the beginning of Cavity Quantum Electrodynamics

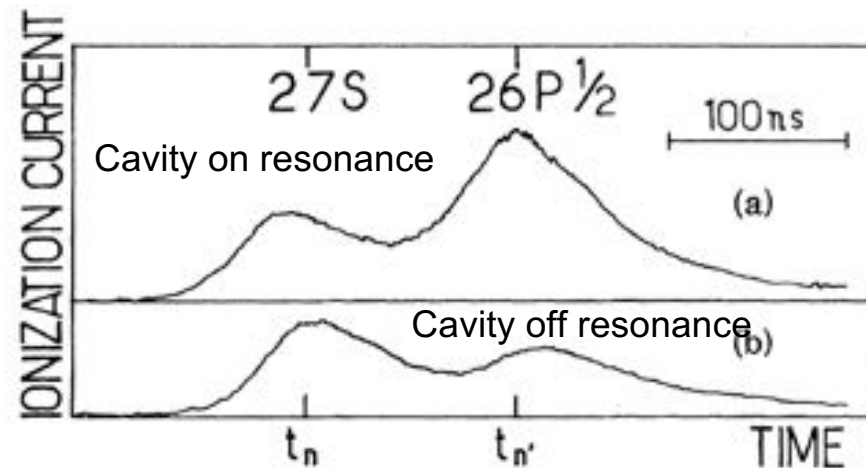

More fundamentally, we believe that these experiments open the way to the study of even smaller emitting systems (i.e., samples smaller than the atomic wavelength or with very small absolute atom number), a domain where there is still no comparison available between experiments and theory.

## Observation of Cavity-Enhanced Single-Atom Spontaneous Emission

P. Goy, J. M. Raimond, M. Gross, and S. Haroche

*Laboratoire de Physique de l'École Normale Supérieure, F-75231 Paris Cedex 05, France*

(Received 1 April 1983)

It has been observed that the spontaneous-emission lifetime of Rydberg atoms is shortened by a large ratio when these atoms are crossing a high- $Q$  superconducting cavity tuned to resonance with a millimeter-wave transition between adjacent Rydberg states.

PACS numbers: 32.80.-t, 32.90.+a, 42.50.+q

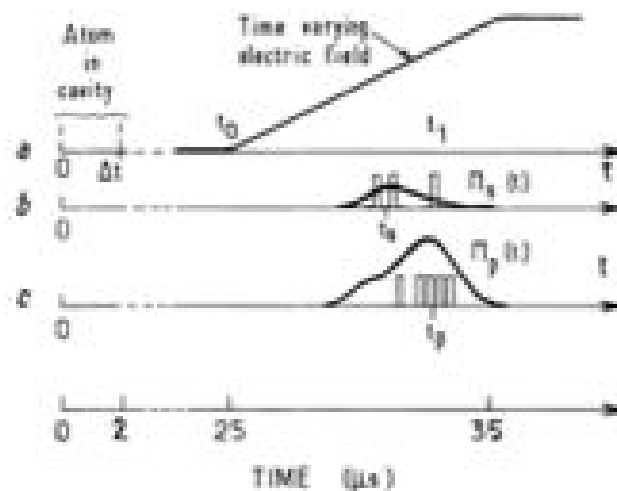

In this respect, the effect described in this Letter can be considered as the limiting case of a transient maser approaching threshold with only one or two atoms in the inverted medium.

With a tenfold increase in  $Q$ ,  $\Gamma_{\text{cav}}$  and  $2\pi\nu/Q$  would become of the same size and the emitted photon would be stored in the cavity long enough for the atom to be able to reabsorb it.

This would correspond to a regime of quantum mechanical oscillations between a two-level atom and a single electromagnetic field mode<sup>4</sup> which should be observable with an improved version of our setup.





With Michel Gross and Claude Fabre (1977?)

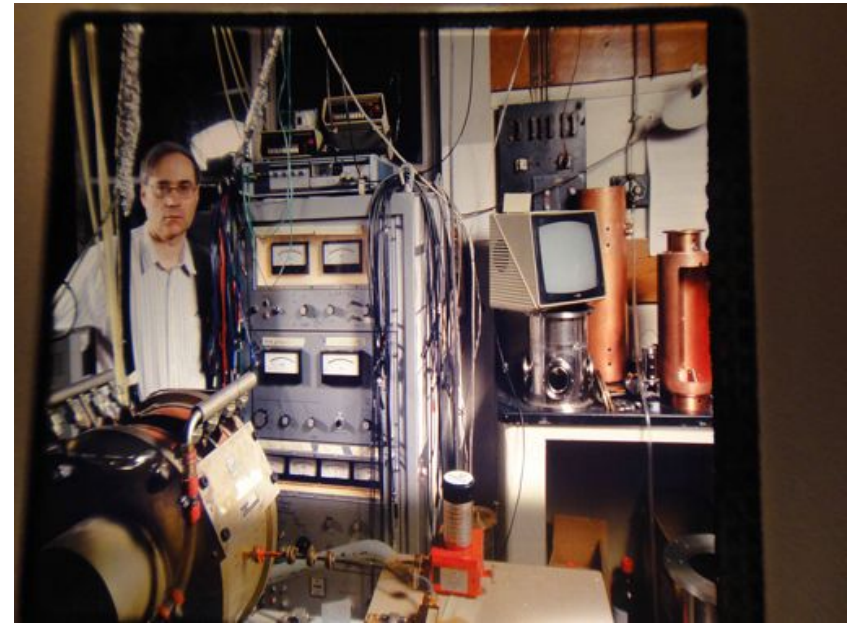

Philippe Goy and his microwave equipment (1978?)



With Yves Kaluzny, Claude Fabre and Jean-Michel Raimond (1980?)

# The Micromaser (1984)

The regime of atom-photon quantum mechanical oscillation (« strong coupling regime » of Cavity QED) was achieved first in the cw micromaser



H. Walther  
(1935-2006)



D. Meschede  
(in 1987)

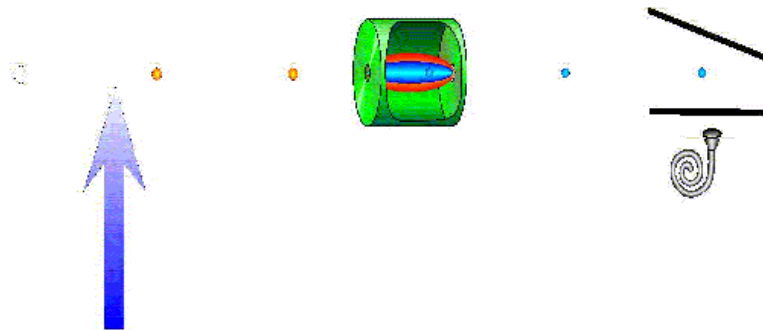

A cylindrical cavity with a very long photon life-time...but atomic superpositions are perturbed by passing through small holes

# Photon detection by photoelectric effect: « chronicle of a foretold death »

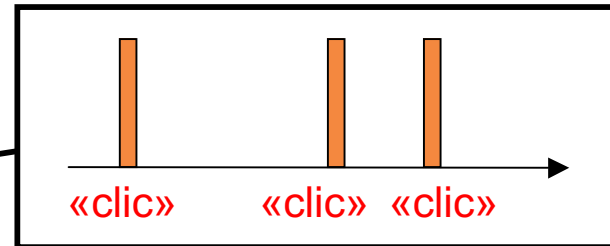
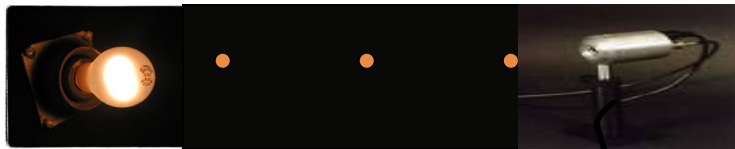

$$|1\rangle \square \square \square \underset{clic}{\square} |0\rangle$$

*A clic projects the field onto the vacuum:  
the photon dies upon delivering its message*

*A Quantum Non-Demolition (QND) measurement should instead realize:*

$$|1\rangle \square \square \square \underset{clic}{\square} |1\rangle \square \square \square \underset{clic}{\square} |1\rangle \square \square \square \underset{clic}{\square} \dots \square \square \square \underset{clic}{\square} |1\rangle \quad ?$$



V. Braginsky

**We need a non-demolition detector at single photon level...  
and a very good box to keep the photons alive long enough**

# Cavity Quantum Electrodynamics:

a stage to witness the interaction between light and matter at the most fundamental level

One **atom** interacts with one (or a few) photon(s) in a box

A sequence of atoms crosses the cavity, couples with its field and carries away information about the trapped light

Photons bouncing on mirrors pass many many times on the **atom**: the cavity enhances tremendously the light-matter coupling

The best mirrors in the world: more than **one billion** bounces and a folded journey of **40.000km** (the earth circumference) for the light!

Photons are trapped for more than a tenth of a second!

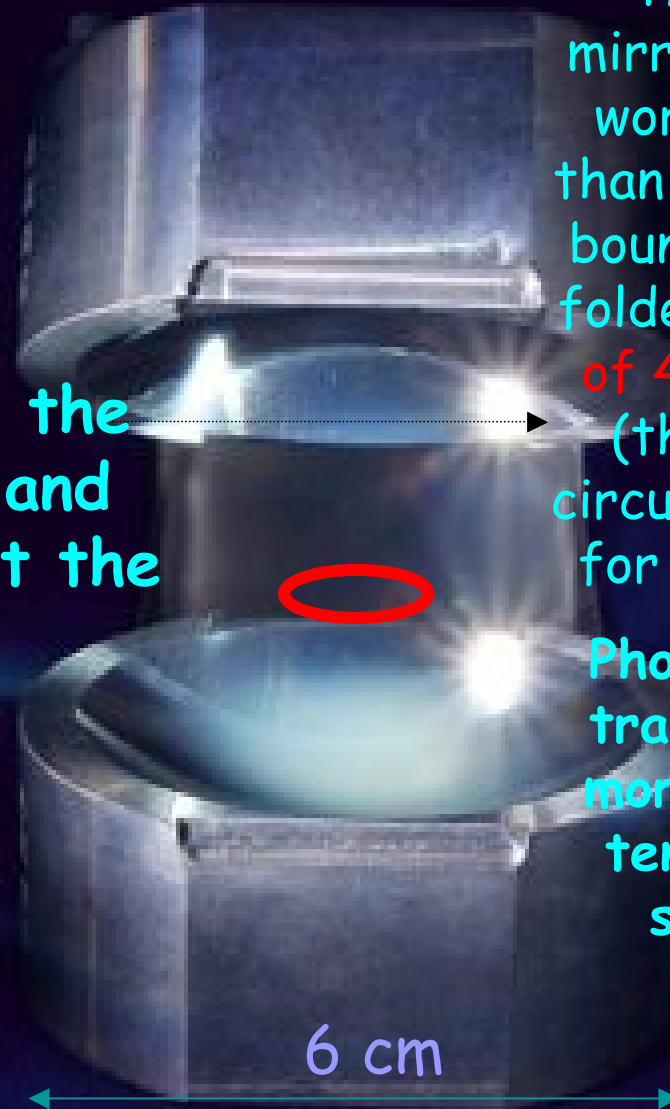



Rydberg

# An extremely sensitive detector: the circular Rydberg atom



D. Kleppner

Atom in ground state:  
**electron** on  $10^{-10}$  m diameter orbit



Atom in circular Rydberg state:

**electron on giant orbit**  
(tenth of a micron diameter)

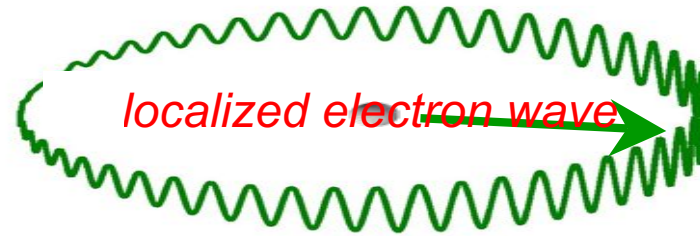

**e** (n=51)

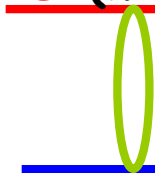

**g** (n=50)

*Electron is localised on orbit by a microwave pulse preparing superposition of two adjacent Rydberg states:  $|e\rangle \rightarrow |e\rangle + |g\rangle$*   
Schrödinger kitten

The localized wave packet revolves around nucleus  
at 51 GHz like a clock's hand on a dial.





When atom interacts with non-resonant light, the clock frequency is slightly modified by the **light shift** effect (Cohen-Tannoudji, 1961)

*Non-resonant* atom experiences *light-shifts* proportional to the photon number  $N$ , with opposite signs in levels  $e$  and  $g$

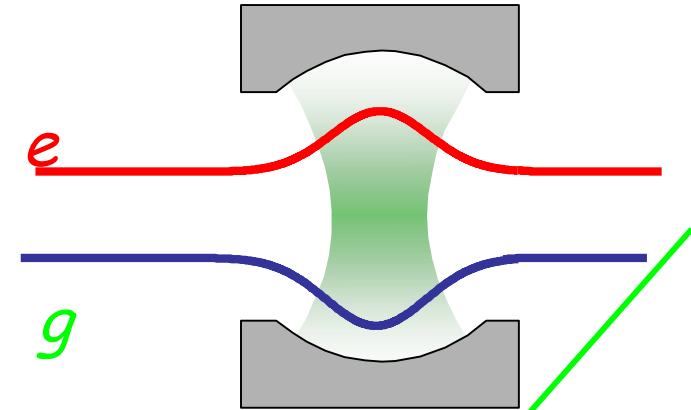

The shifts result in a phase shift of the atomic dipole when atom crosses the cavity:

$$\Delta\Phi(N) = N\varphi_0$$

$\varphi_0$ : phase shift per photon  
can be as large as  $\pi$

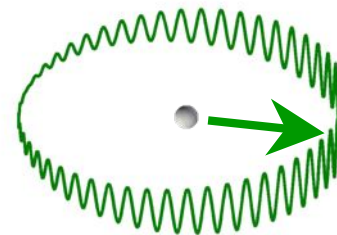

0 photon

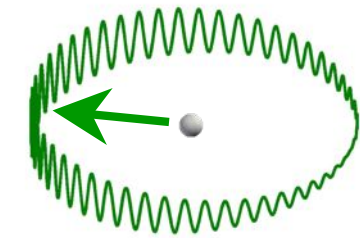
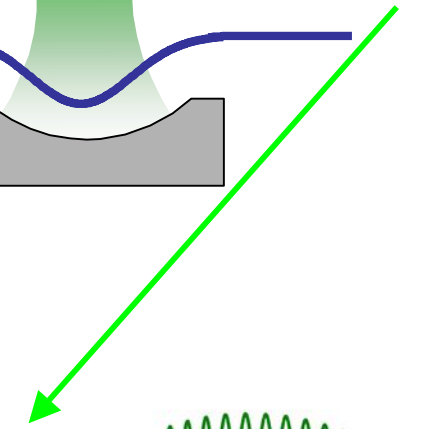

1 photon

Measuring  $\Delta\Phi$  amounts to a QND photon counting



# An artist's view of set-up...

Classical pulses  
(Ramsey interferometer)

**N. Ramsey**  
(D. Wineland's PhD  
advisor)

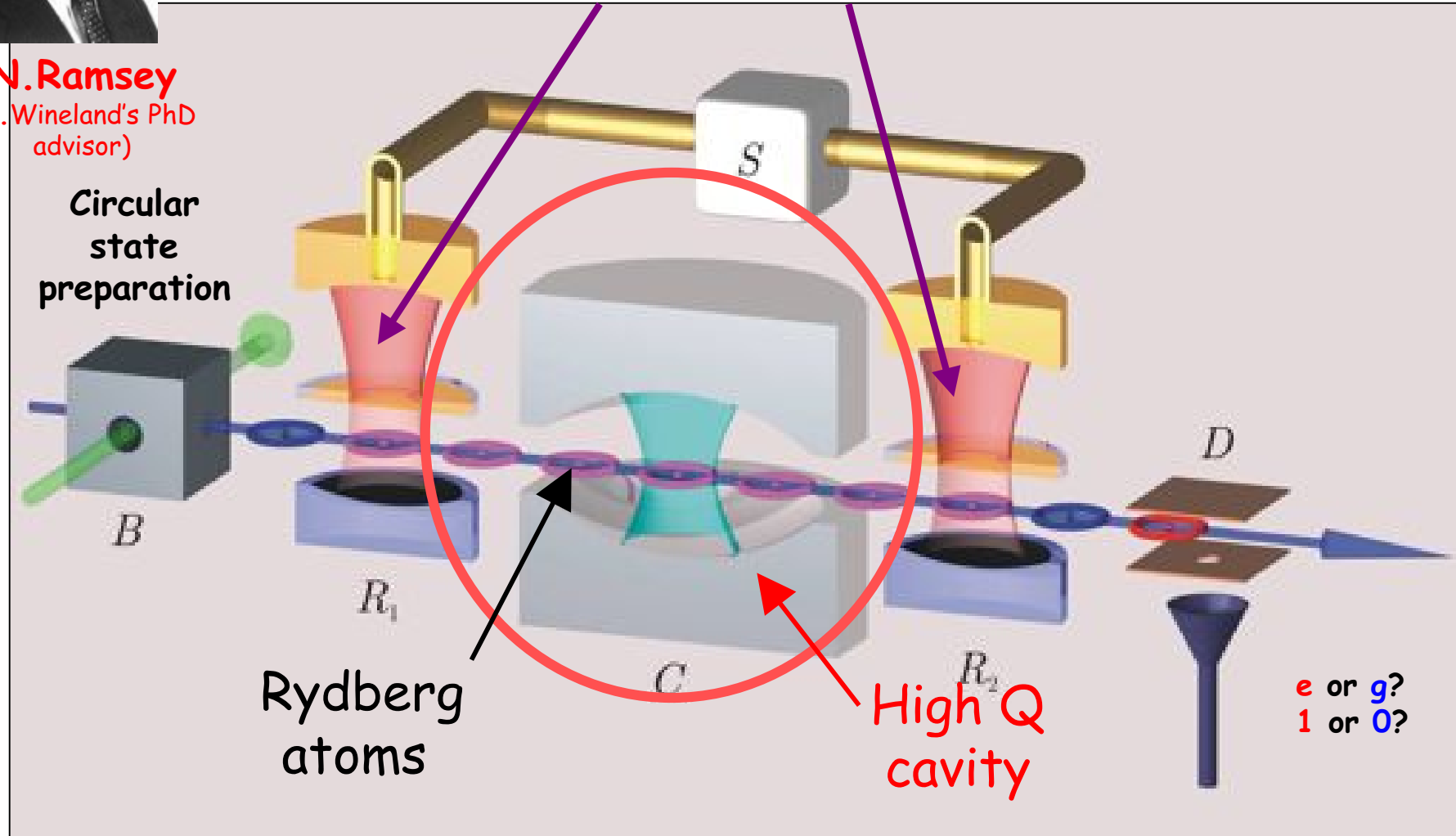

An atomic clock delayed by photons trapped inside

# Birth, life and death of a photon

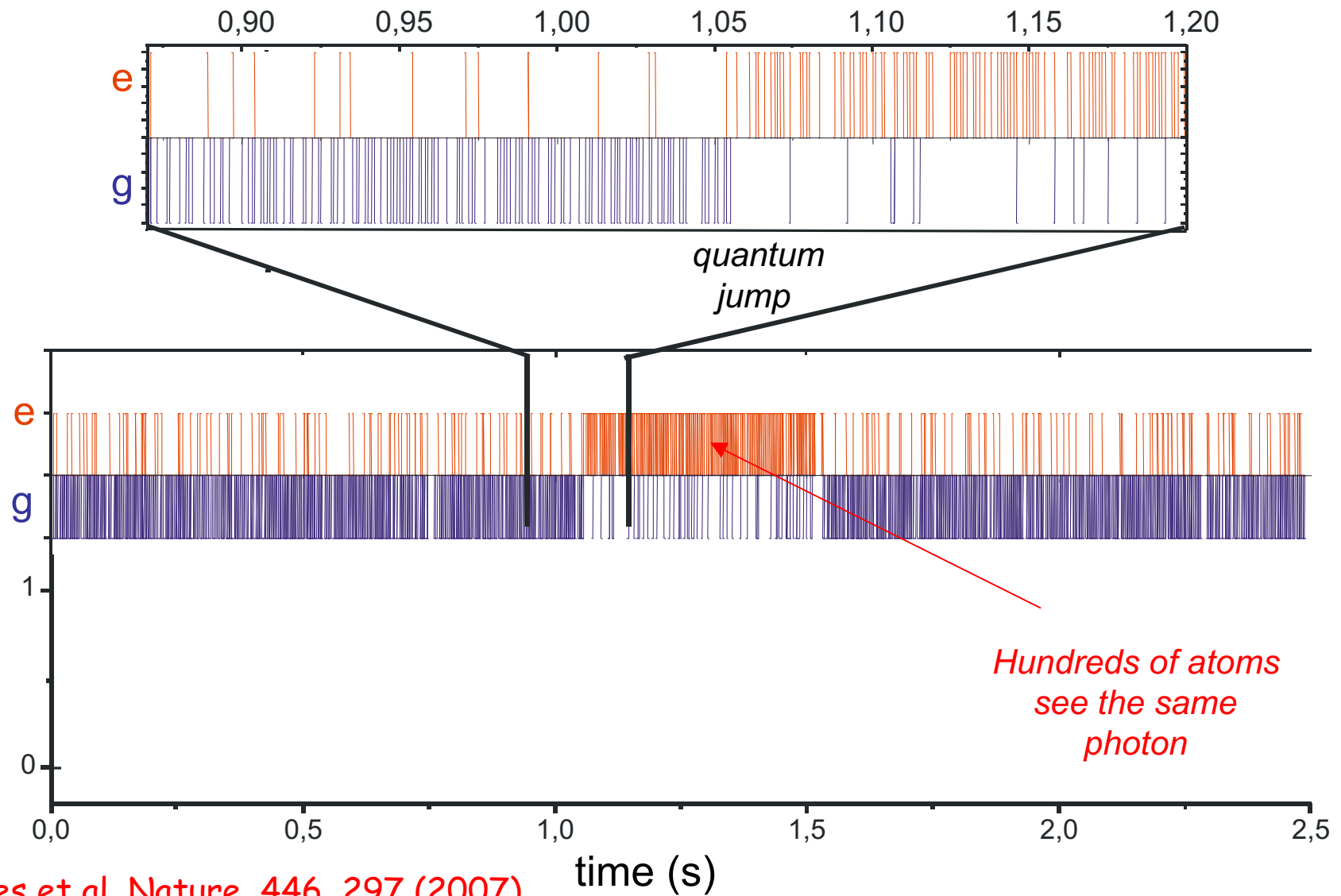

S.Gleyzes et al, Nature, 446, 297 (2007)



# Progressive collapse as $n$ is pinned down to one value

Which number will win the race?

$n = 7 \ 6 \ 5 \ 4 \ 3 \ 2 \ 1 \ 0$

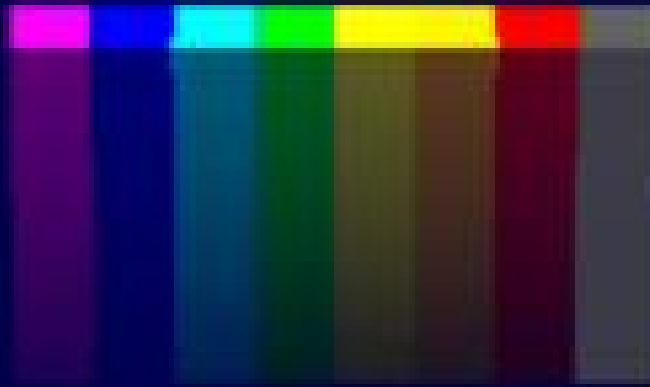

# Field quantum jumps due to cavity losses

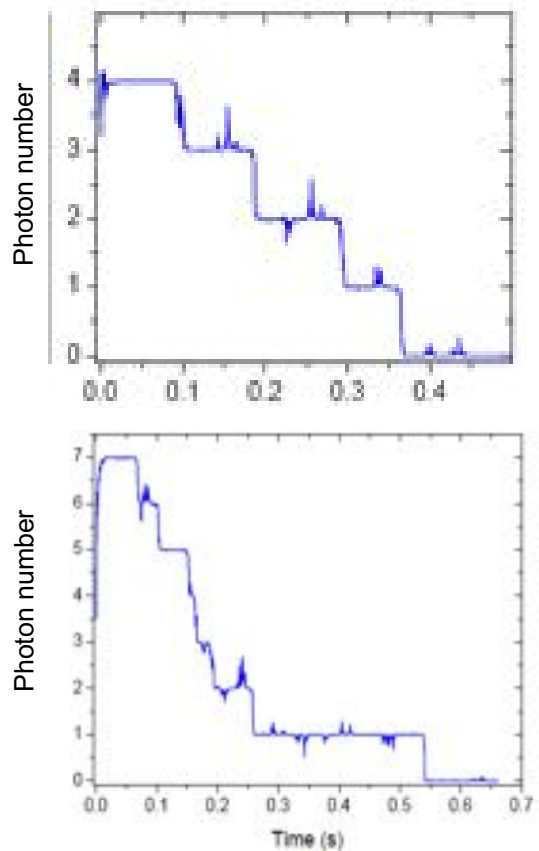

C. Guerlin et al., *Nature*, 448, 889 (2007)

# Photon number states stabilized by quantum feedback (4 and 7 photons)

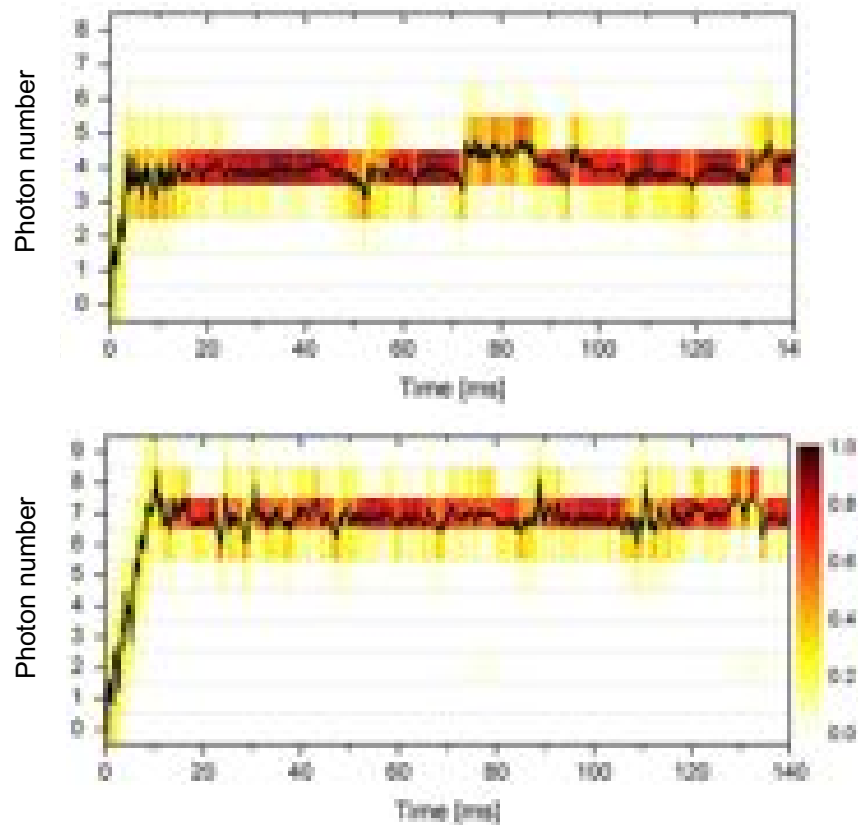

C. Sayrin et al., *Nature* 477, 73 (2011)

X. Zhou et al., *Phys. Rev. Lett.* 108, 243602 (2012)

Exploring the wave nature of trapped light  
and taming photonic Schrödinger cats

LIGHT IS A

particle!

# Schrödinger cat story: A large system coupled to a single atom ends up in a strange superposition...

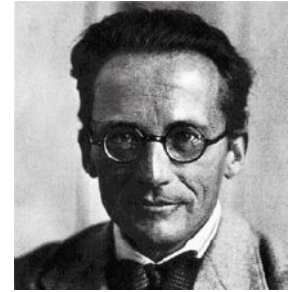

$$a_{\text{vivant}} | \text{atom} \text{ cat in box} \rangle + b_{\text{mort}} | \text{atom} \text{ cat out of box} \rangle$$



**Our version:  
a coherent  
field coupled  
to a single  
atom  
collapses into  
a superposition  
of two fields  
with opposite  
phases**

---

# A coherent state of light frozen at a given time

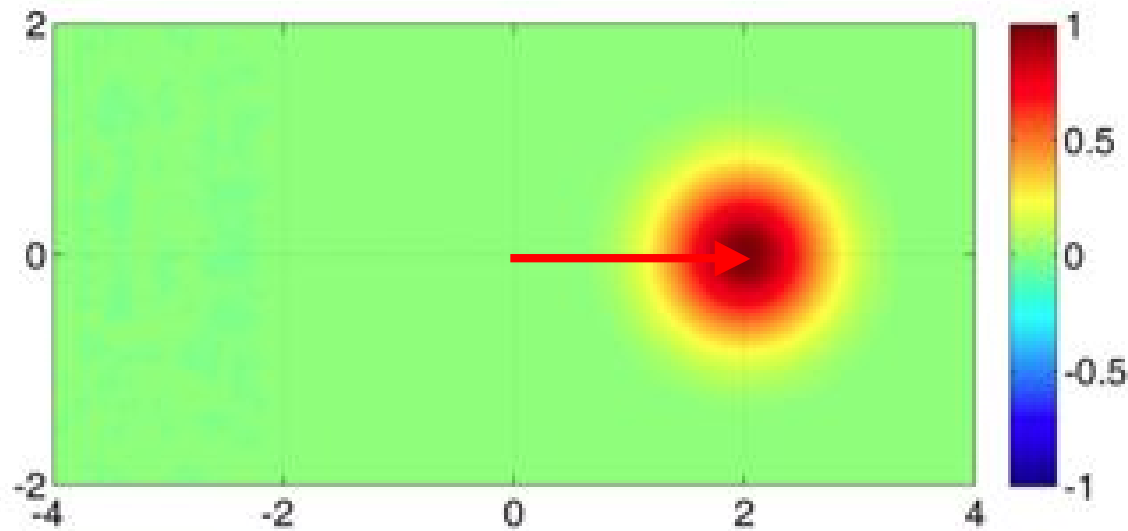

The Wigner function is a 2D real function describing the state of the field



M.Brune



L.Davidovich

Manipulation of photons in a cavity by dispersive atom-field coupling: Quantum nondemolition measurements and generation of "Schrödinger cat" states

M. Brune, S. Haroché, and J. M. Raimond

Laboratoire de Spectroscopie Motrice et d'Échelle Normale Supérieure, 24 rue Lhomond, 75231 Paris CEDEX 05, France

L. Davidovich and N. Zagury

Departamento de Física, Pontificia Universidade Católica, 22451 Rio de Janeiro, Brazil

(Received 1 November 1989)

A quantum nondemolition method to measure the number of photons stored in a high-Q cavity, introduced by Brune et al. [Phys. Rev. Lett. 65, 974 (1990)], is described in detail. It is based on the detection of the dispersive phase shift produced by the field on the wave function of noninteracting atoms crossing the cavity. This shift can be measured by atomic interferometry, using the Ramsey separated-oscillatory-field method. The information acquired by detecting a sequence of atoms modifies the field step by step, until it eventually collapses into a Fock state. At the same time, the field phase undergoes a diffusive process as a result of the back action of the measurements on the photon-number conjugate variable. Once a Fock state has been generated, its evolution under weak perturbation can be continuously monitored, revealing quantum jumps between various photon numbers. When applied to an initial coherent field, the intermediate steps of the measuring sequence produce quantum superpositions of two equal fields, known as "Schrödinger cat states." Ways to prepare and detect these states in a cavity subjected to a weak relaxation process are discussed. The effects analyzed in this article could realistically be observed by using circular Rydberg atoms and very high-Q superconducting microwave cavities. The possibility of photon "manipulation" through measurement atom-field interactions opens a domain in cavity QED studies.



J-M.Raimond



N.Zagury

decoherence

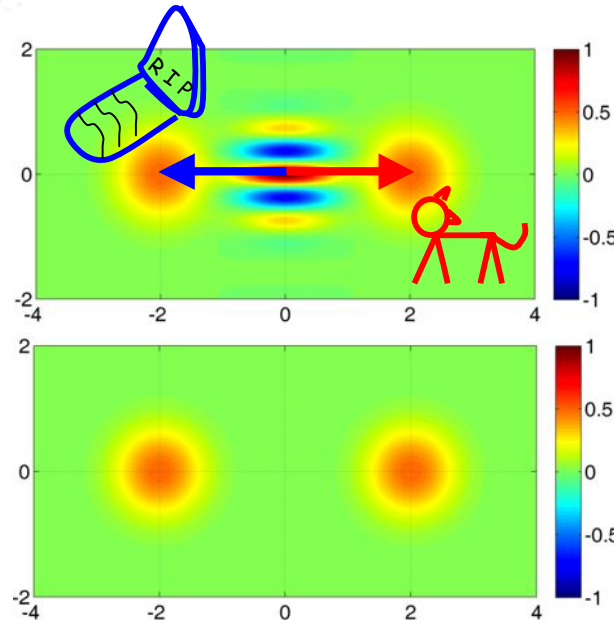

Schrödinger cat state

Classical mixture of « live » and « dead » states

# How single atom prepares Schrödinger cat state of light

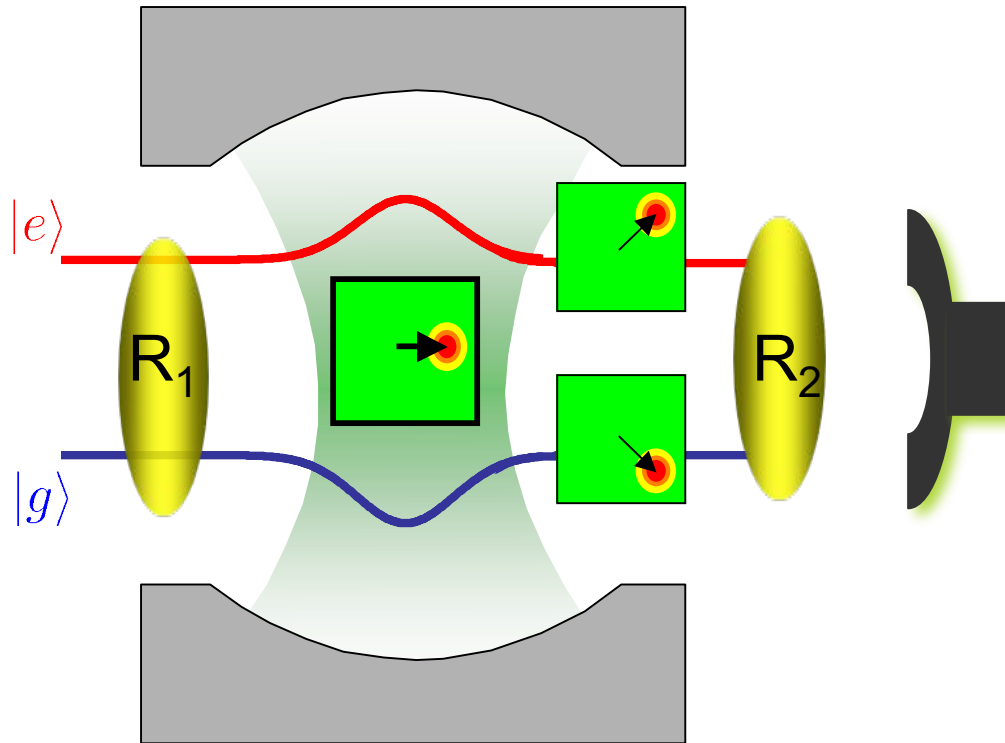

1. Single atom is prepared in  $R_1$  in a superposition of  $e$  and  $g$

2. Atom shifts the field phase in two opposite directions as it crosses  $C$ : superposition leads to entanglement in typical Schrödinger cat situation:  
field is a 'meter' reading  
atom's energy

3. Atomic states mixed again in  $R_2$  maintains cat's ambiguity:

Detecting atom in  $e$  or  $g$  projects field into cat state superposition!

# Reconstructed Wigner function of a cat

(modified version of QND measurement using sequence of atoms crossing C)

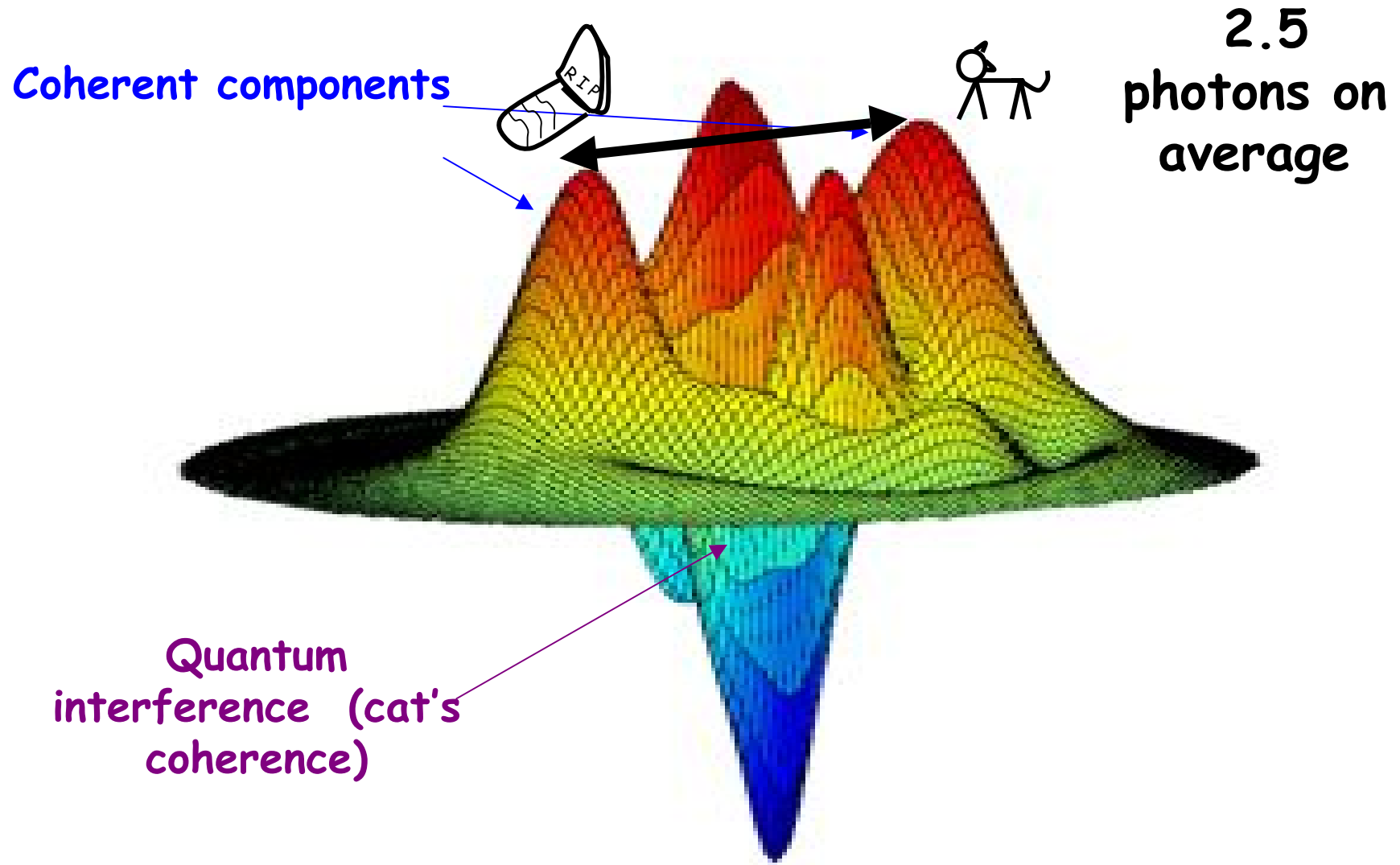

S. Deléglise et al, Nature, 455, 510 (2008)



# Fifty milliseconds in the life of a Schrödinger cat (a movie of decoherence)

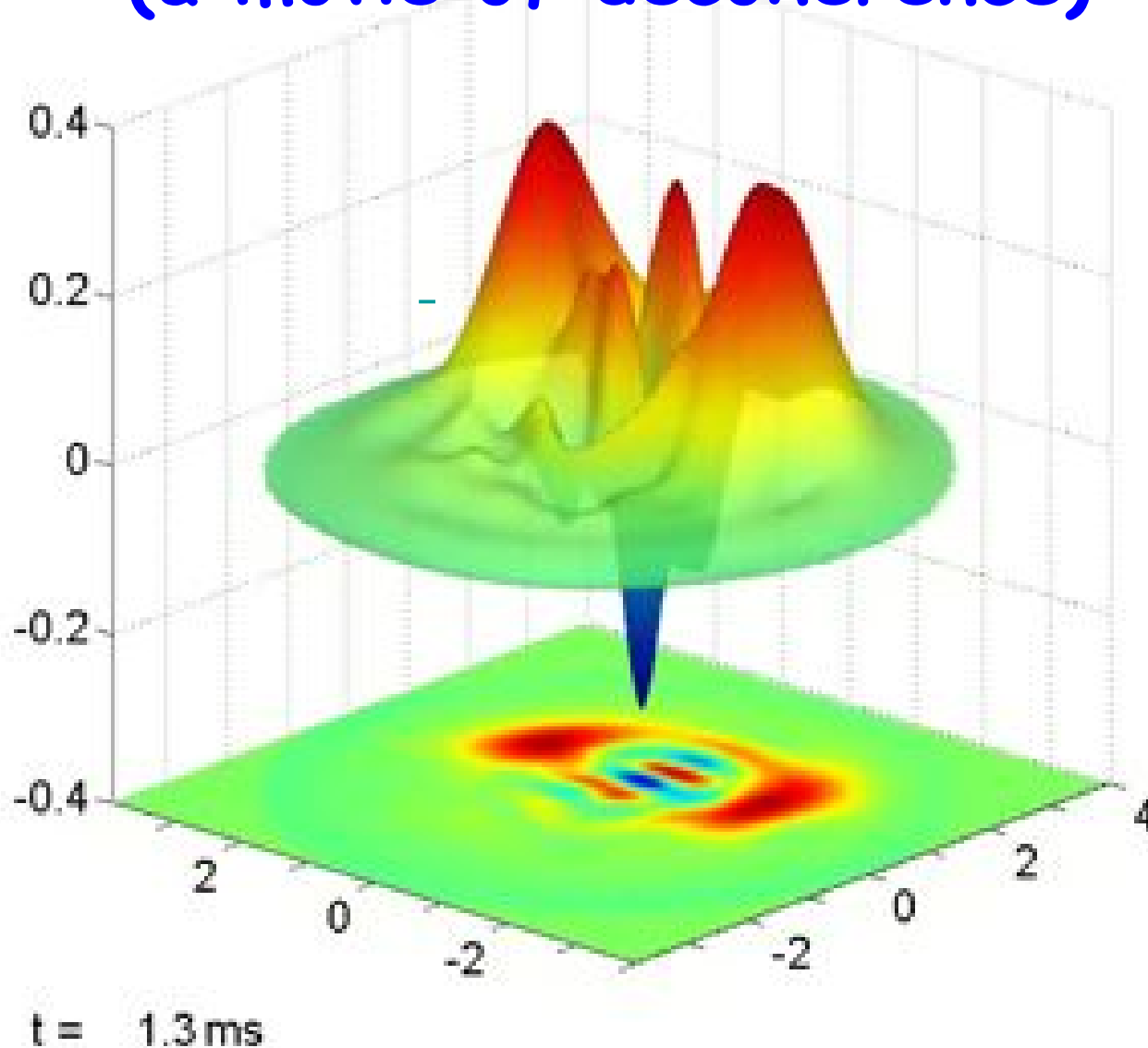

W.Zurek

Earlier version of experiment:  
Brune et al, PRL,77, 4887 (1996)

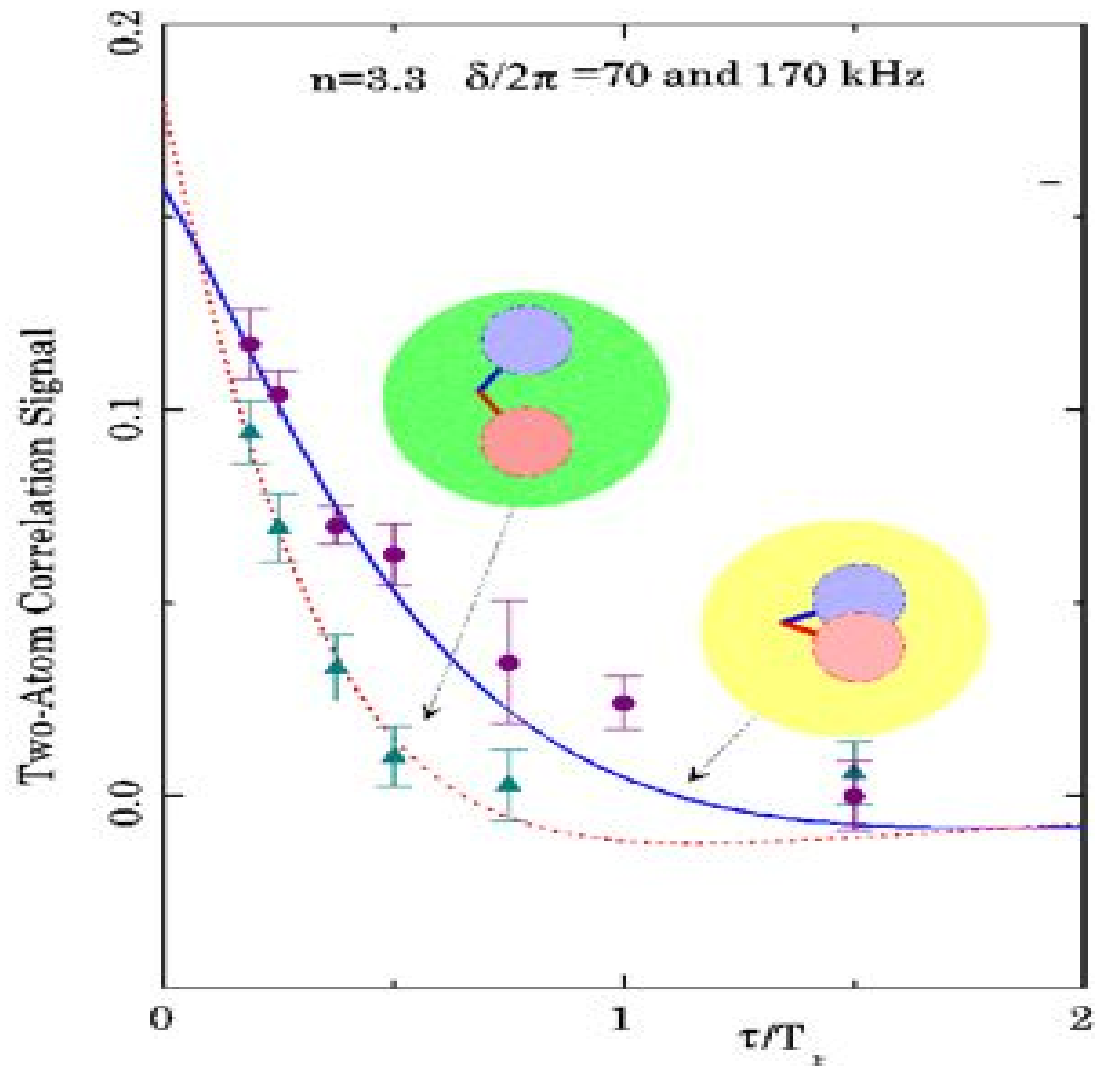

# Cavity QED: coupling real or artificial atoms to a field trapped in a resonator

H. Kimble,



G. Rempe

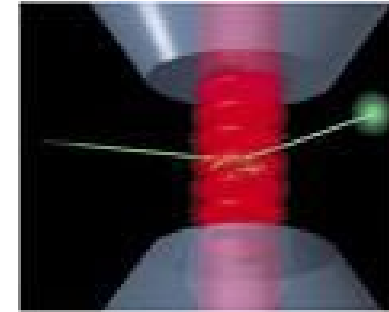

Cold atoms in optical cavities/microchips

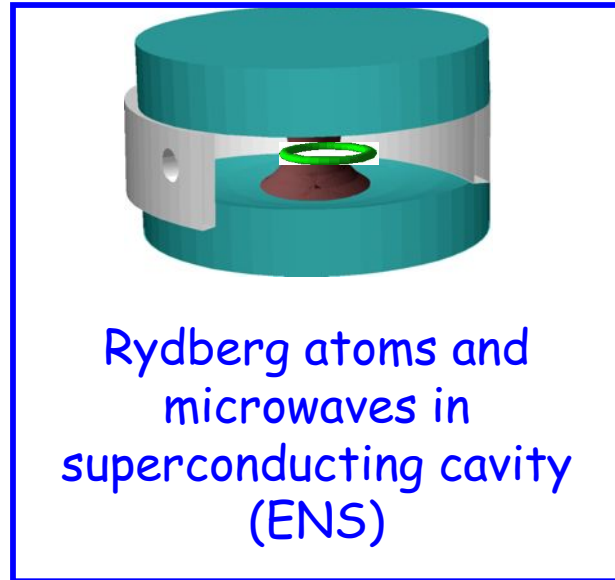

Rydberg atoms and microwaves in superconducting cavity (ENS)



Atoms or quantum dots coupled to optical microresonators



Quantum dots in semiconductors. Photonic bandgaps

Yale, USBC, Saclay, ETH, Chalmers, NEC, NIST, Delft, MIT, Berkeley, Grenoble, etc...

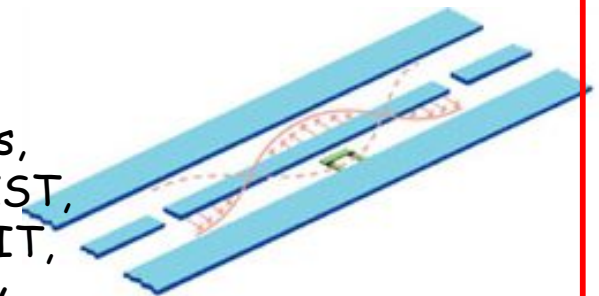

Circuit QED with Josephson junctions coupled to coplanar lines or 3D photon boxes

# A zoo of Schrödinger cats

## Atomic CQED

Deléglise et al,  
Nature, 455, 510  
(2008)

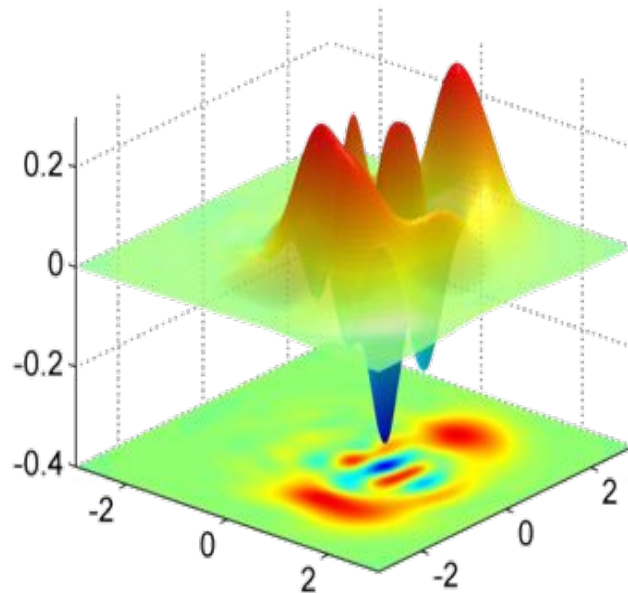

Schrödinger cat  
generated by single  
atom index effect

## Circuit QED (Yale)

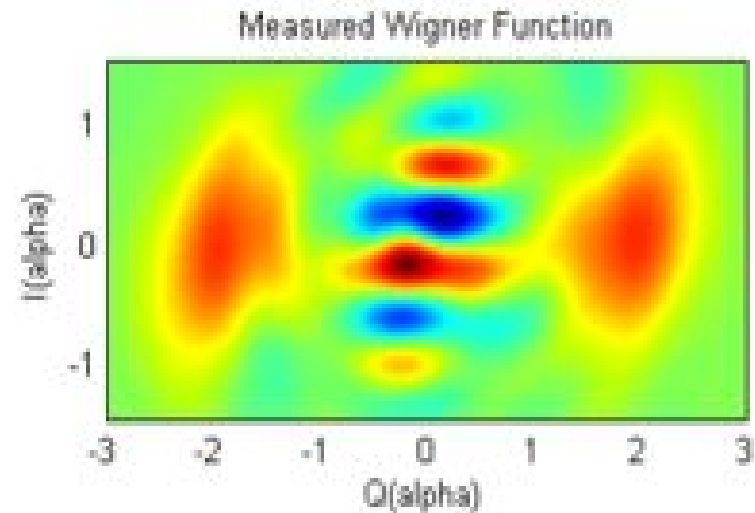

G.Kirchmair, B.Vlastakis, M.Mirrahimi,  
Leghtas et al, in preparation (2012)

Schrödinger cat state  
generated by Kerr effect

Other circuit QED cats raised at  
USBC (Santa Barbara)

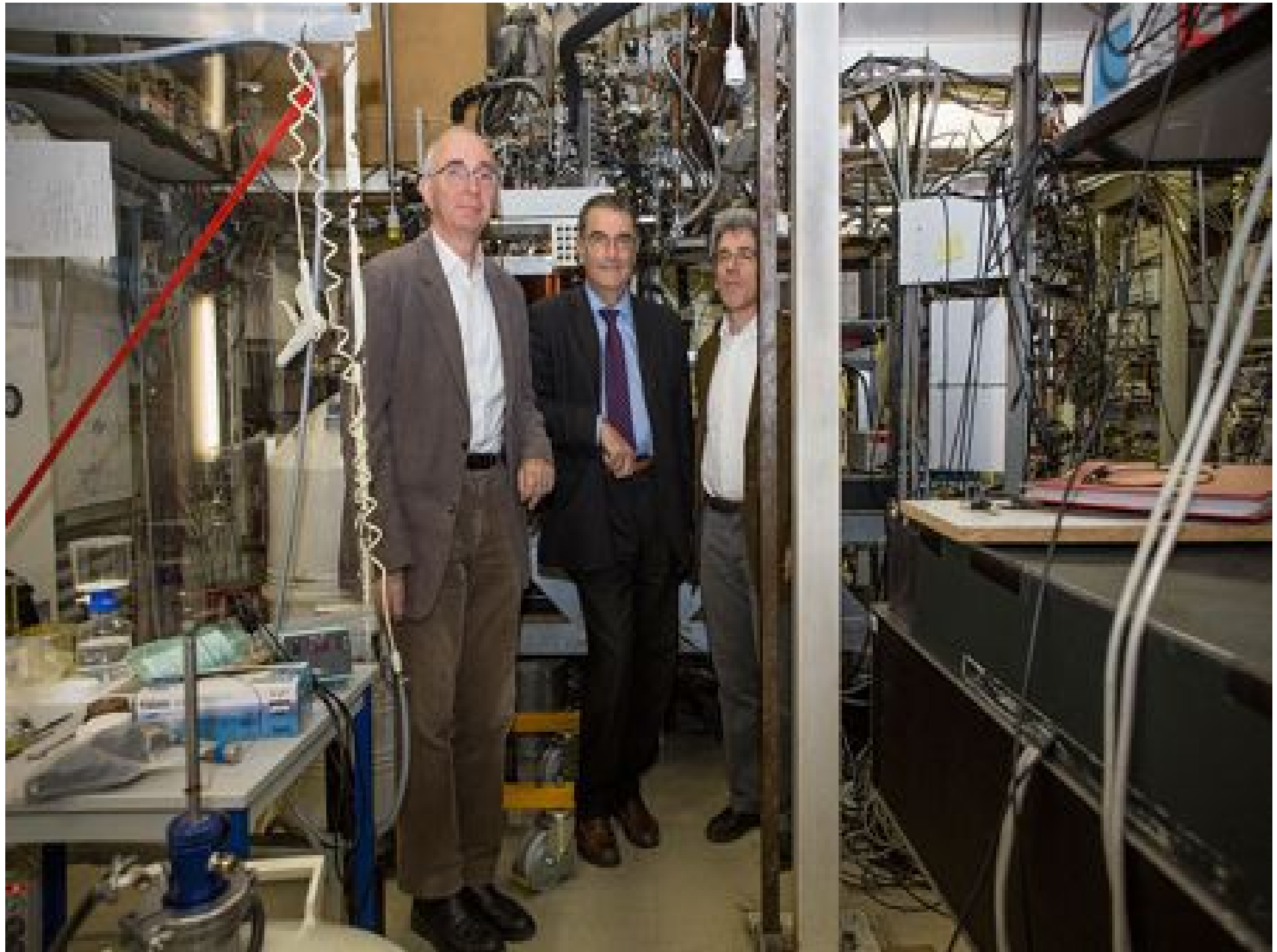

October 10 2012



M. Brune

J.-M. Raimond

T. Dotsenko

S. Gleyzes

Same lab room,  
46 years earlier...



October 1966 (after Kastler's Nobel Prize announcement)

*F.Laloë*

*C.Cohen-Tannoudji,  
Nobel 1997*

*A.Kastler,  
Nobel 1966*

*S.H*

*A.Omont  
J.Brossel*