

# G PROTEINS AND REGULATION OF ADENYLYL CYCLASE

Nobel Lecture, December 8, 1994

by

ALFRED G. GILMAN

Department of Pharmacology, The University of Texas Southwestern Medical Center, Dallas, Texas 75235, USA

## INTRODUCTION

Earl Sutherland, a friend of my father, wrote to me in the spring of 1961 with a proposal to participate in what was then an educational adventure – a combined M.D.-Ph.D. training program that he had devised at Western Reserve University (now Case Western Reserve University) in Ohio. My reaction was entirely negative. I thanked him, politely I think, but the idea of spending seven years in Cleveland had little appeal. Happily, Sutherland was persistent. He wrote again in the fall of 1961 (the beginning of my last year in college), I decided the idea was worth a visit, and I had my first glimpse of cyclic AMP (for whose discovery, in 1957, Sutherland was awarded the Nobel Prize [in 1971]). Cyclic AMP, Sutherland, and the M.D.-Ph.D. Program all looked rather appealing. Thus, on my arrival in September, 1962, I was disappointed to learn that Sutherland was about to depart for Vanderbilt University. However, there was an attractive opportunity to work with Theodore Rall, Sutherland's younger collaborator, who had played a pivotal role in the crucial experiments of 1957. I entered the Rall lab, and in over 30 subsequent years have never escaped the lure of cyclic nucleotide research, despite occasional attempts to try. The most determined of these efforts came with my choice of Marshall Nirenberg's newly proclaimed neurobiology laboratory for postdoctoral training. However, in our first conversation after my arrival at the National Institutes of Health in Bethesda, Marshall asked me to establish an assay for cyclic AMP in his laboratory. Trapped again, but I didn't fight back very vigorously.

Rall and Sutherland's discovery of cyclic AMP and adenylyl cyclase, the hormone-sensitive enzyme that synthesizes the cyclic nucleotide from ATP, gave birth to the concepts of transmembrane signaling and of hormone-regulated synthesis of intracellular second messengers (Fig. 1). Both men were trained as biochemists (Sutherland with Carl Cori, Rall with Albert Lehninger), and together they initiated a classical reductionistic approach to deciphering hormone action. In the 1950's, hormones could almost be defined as regulatory molecules that would act only on intact cells. Sutherland and Rall's coup was to assemble a system in which a characteristic effect of epinephrine and glucagon (activation of phosphorylase) could be observed

in homogenates and then to dissect the system into its major components – hormone-stimulated synthesis of a factor, cyclic AMP, by the particulate fraction and subsequent action of the factor in the cytosol to activate phosphor-ylase (1). An assay (albeit torturous) for adenylyl cyclase was in hand, and hormone action could then be studied by adding ATP to plasma membranes

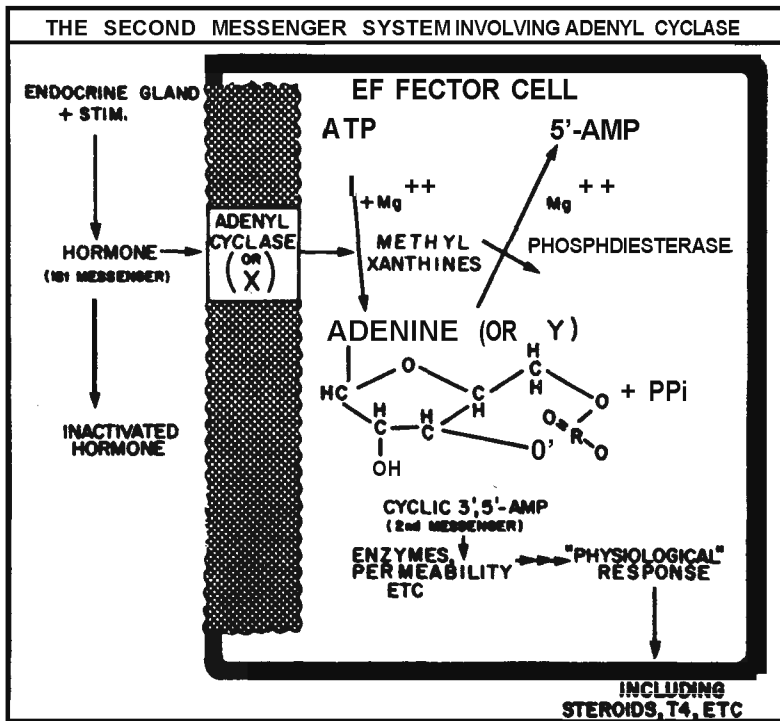

Fig. 1. An early pictorial formulation of Sutherland's second messenger concept.

Although the concept of receptors for endogenous regulatory molecules and drugs arose with the pharmacological experiments of Langley and Ehrlich in the late nineteenth and early twentieth centuries, the word evoked only metaphysical feelings in many at the time of the discovery of cyclic AMP. The term "receptor" does not appear in the index of the 1955 edition of *The Pharmacological Basis of Therapeutics*, the standard textbook of Pharmacology, but the following sentence is there: "Years ago, Langley named the differentiating substance the 'receptive substance'; this term is still widely employed, but it must be realized that the 'receptor' may not be a morphologically demonstrable structure." Rall and Sutherland's experiments provided test-tube assays for receptors, and the assays demonstrated that the receptors were authentic. The effects of epinephrine and congeners on adenylyl cyclase were shown to conform to Ahlquist's new conceptualization of  $\beta$ -adrenergic receptors (as distinguished from a receptors), and the effects were blocked with the first, newly discovered  $\beta$ -adrenergic antagonist (2). Biochemical approaches to receptors were thus born, and the question arose

of the relationship of the  $\beta$ -adrenergic receptor to adenylyl cyclase. Could the enzyme be the receptor? Perhaps, but this model would demand the existence of a family of adenylyl cyclases with distinct regulatory sites, because regulation of the enzyme was shown not to be restricted to epinephrine and glucagon; ACTH, TSH, LH, ADH, and other stimulators were soon in evidence, as was inhibition of adenylyl cyclase activity by cholinergic agonists [3].

Over a decade after the discovery of adenylyl cyclase, Martin Rodbell and colleagues provided reasonably compelling, although indirect, evidence that receptors and adenylyl cyclases were distinct molecular entities. The adenylyl cyclase of adipocytes is stimulated by a myriad of hormones. If there were distinct cyclases that each also served as a receptor, responses to maximally effective concentrations of hormones would be additive. They were not, implying that distinct receptors could interact with a common pool of adenylyl cyclase (4). The issue was resolved definitively in the 1970's with the advent of ligand binding assays for receptors. Receptors could finally be examined by methods that did not rely on detection of a functional response. It was then possible to solubilize and resolve adenylyl cyclase from the  $\beta$ -adrenergic receptor, proving that they were distinct macromolecules (5, 6).

#### EARLY TIMES FOR G PROTEINS

The question of the moment thus became the mechanism of interaction or "coupling" between receptors and adenylyl cyclase. The relatively simple notion that an agonist-receptor complex could act as an allosteric regulator of the enzyme was also challenged by Rodbell, who first promulgated the notion of a "transducer" acting as an intermediary between receptors and adenylyl cyclase (7). Although this notion was at first based predominantly on excellent instinct and the lipid bilayer was named as a candidate transducer, supportive data for something more specific were soon forthcoming. Rodbell, Birnbaumer, and their colleagues made the surprising discovery that one regulatory ligand (the receptor agonist) was not sufficient to activate adenylyl cyclase. A hormone could not activate the enzyme unless guanosine triphosphate (GTP) was also present [8]. This crucial observation had been missed for over a decade because of contamination of both membrane preparations and substrate ATP with sufficient ( $\mu\text{M}$ ) concentrations of GTP to meet the requirement. It was subsequently determined that hormonal inhibition of adenylyl cyclase activity was similarly dependent on GTP [9]. I will leave it to Rodbell to describe these observations in more detail. However, it should be noted that there was considerable skepticism about the significance of the findings (Fig. 2), in part generated by difficulties in reproduction of the result; most were not working with the very nice membrane preparations that characterized the Rodbell laboratory.

Several observations of the mid-1970's spoke to the undeniable importance of GTP in regulation of hormone-sensitive adenylyl cyclase activity. Most significantly, Cassel and Selinger detected a hormone-stimulated GTPase



Fig. 2. A cartoon from the 1970s, drawn by Dr. Pierre DeMeytes, suggested that not all investigators could readily observe the requirement for GTP in transmembrane signaling. (Printed with permission from Dr. DeMeytes.)

activity that appeared to be associated with activation of adenylyl cyclase, and, despite enormous technical difficulties, they correctly deduced (from kinetic analysis) the significance of the GTPase in terminating a hormonally-mediated signal [10]. Consistent with these thoughts, Londos and Schramm and coworkers had noted that nonhydrolyzable analogs of GTP, such as Gpp(NH)p, activated adenylyl cyclase dramatically and without the need for hormone [11, 12]. Michael Maguire, my first postdoctoral fellow, discovered that GTP decreased the affinity of receptors selectively for agonists, but not for antagonists (13). The interpretation of this counter-intuitive observation was not clear, but it surely appeared to be significant.

Throughout this time a few brave souls had attempted to solubilize and purify components of hormone-sensitive adenylyl cyclase systems. All encountered great difficulties. Hormonal responsiveness was quickly lost on solubilization with detergents, and adenylyl cyclase itself appeared to be remarkably labile. Eva Neer was perhaps the first to treat the enzyme as an approachable biochemical object, with a careful exploration of its hydrodynamic properties (14). Despite this, a conventional biochemical approach to the system looked difficult indeed.

The turning point, for us, started with the description by Daniel et al. [15] of the cytotoxic effect of cyclic AMP on clonal S49 lymphoma cells. Bourne and associates were soon able to isolate a variant (cyc-) of these cells that appeared to lack adenylyl cyclase [16], despite continued expression of a normal number of R-adrenergic receptors (17). We were able to select another S49 cell variant that intrigued us even more – an uncoupled (UNC) mutant that appeared to have normal receptors and adenylyl cyclase but that failed to generate a cyclic AMP signal in response to appropriate hormones ( $\beta$ -adrenergic agonists or prostaglandins) [18]. The availability of these genetic

variants made the biochemistry appear more approachable, particularly to Elliott Ross, an extremely talented and well-trained membrane biochemist who joined my lab in 1975. Ross sought to reconstitute the *cyc*<sup>-</sup> mutant *in vitro*, first by extracting adenylyl cyclase from cells that lacked Radrenergic receptors and then by somehow coaxing the protein back into fruitful interactions with the receptors present in *cyc*<sup>-</sup> membranes. The experiment eventually worked; *cyc*<sup>-</sup> membranes were reconstituted to display catecholamine-sensitive adenylyl cyclase activity (19). We were pleased that we had taken the first step in resolution and reconstitution of the system, but we had little idea how quickly the investment would pay dividends. The reconstitution had not worked for the anticipated reasons. When we inactivated the adenylyl cyclase in the detergent extract used for the reconstitution, we still observed undiminished levels of hormone-stimulated adenylyl cyclase activity. That is, addition of a detergent extract devoid of adenylyl cyclase activity to receptor-

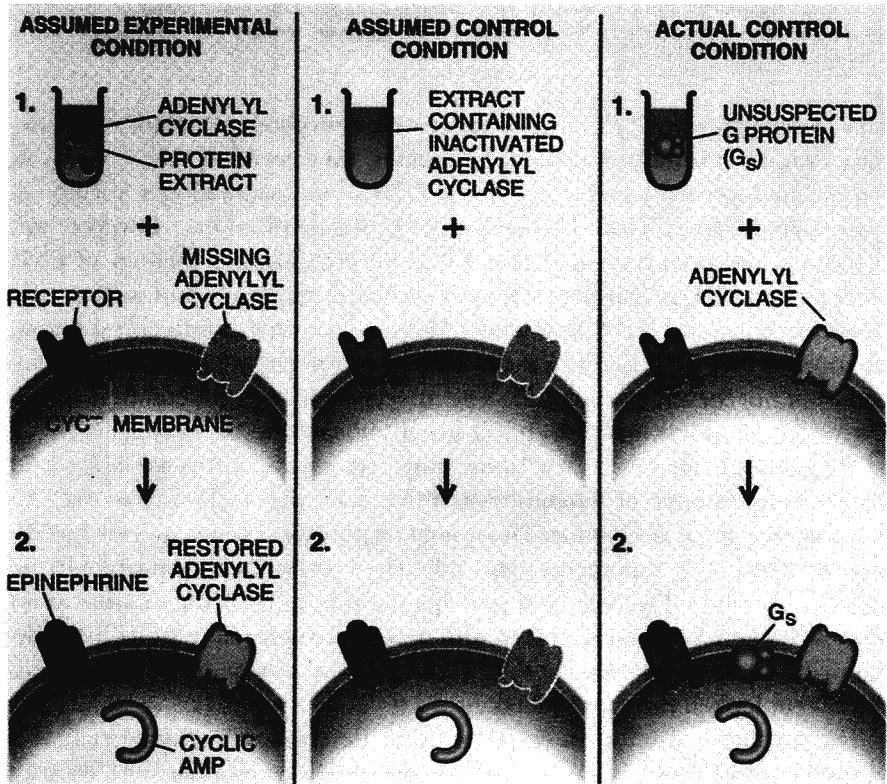

fig. 3. Experiments leading to the discovery of  $G_s$ . A: Cartoon of the protocols. In the first experiments, Elliott M. Ross added a detergent extract of membrane proteins to so-called *cyc*<sup>-</sup> membranes (left, 1), which were thought to lack adenylyl cyclase. Epinephrine stimulated cyclic AMP production (2), which seemed to indicate that adenylyl cyclase had been inserted into the deficient membranes. In the control experiment, the adenylyl cyclase in the extract was inactivated (center, 1). Even without it, epinephrine caused the *cyc*<sup>-</sup> membranes to make cyclic AMP. This puzzling finding led to the discovery that the *cyc*<sup>-</sup> membranes did contain adenylyl cyclase (right, 1) but lacked a third component necessary to activate it – a G protein that persisted in the extract after adenylyl cyclase had been inactivated. Restoration of the G protein to the membranes enabled adenylyl cyclase to synthesize cyclic AMP. Reprinted from Linder and Gilman [154], with permission.

containing  $cyc^-$  membranes (which also had no adenylyl cyclase activity) led to restoration of the complete response (Fig. 3). Treatments with proteases quickly revealed that both the detergent extract and the  $cyc^-$  membranes contained proteins that were necessary for observation of *any* adenylyl cyclase activity – basal or that stimulated by hormones, fluoride, or guanine nucleotides. (We now know that the specific isoforms of adenylyl cyclase that predominate in S49 cells have notably low basal activity.) Thus two proteins were required – the catalyst or adenylyl cyclase itself, which in fact *was* present in so-called  $cyc^-$  membranes, and a stimulatory protein, deficient in  $cyc^-$  membranes, that had survived the mild conditions used to inactivate adenylyl cyclase in the extract used for reconstitution. We proposed that the role of the hormone receptor was to regulate the interaction between these two components (20, 21). Coincidentally, Pfeuffer achieved partial resolution between adenylyl cyclase and an activating protein that bound selectively to a guanine nucleotide-based affinity resin (22).

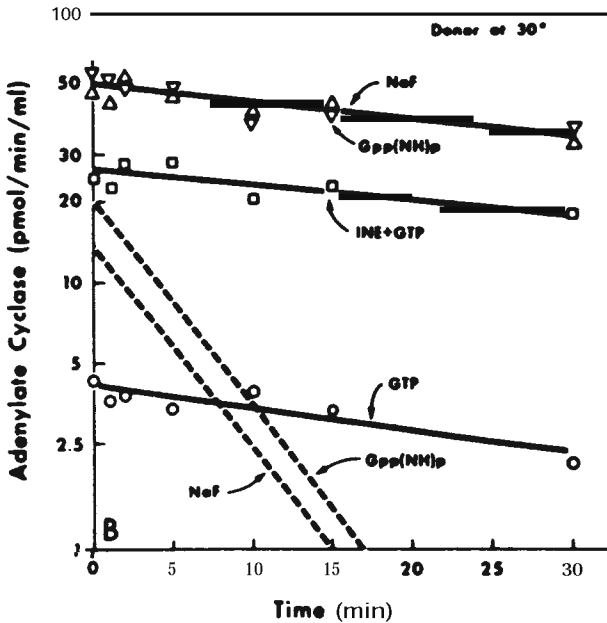

Fig. 3. Data from these experiments. Reconstitution of hormone-sensitive adenylyl cyclase by mixture of  $cyc^-$  membranes with heat inactivated wild type membrane extracts. Detergent extracts of wild type membranes were heated at  $30^\circ\text{C}$  for the times indicated on the abscissa, chilled, and mixed with  $cyc^-$  membranes. The NaF- and Gpp(NH)p-stimulated adenylyl cyclase activities of the incubated extracts are shown by the dashed lines. Aliquots of the reconstituted mixtures, prepared with these incubated extracts, were assayed with GTP, isoproterenol (a congener of epinephrine) plus GTP, NaF, or Gpp(NH)p, as indicated. Reprinted from Ross et al. [21], with permission.

The novel protein became the object of our attentions, in part because of its more mysterious nature and in part because it was not as labile as adenylyl cyclase. Additional experiments by Ross implied that the protein (at the time termed G/F, but eventually named  $G_s$ ) was the site of action of guanine

nucleotides (and fluoride). [21], and these hypotheses were strengthened by hydrodynamic characterization of the activity by Allyn Howlett; she detected Gpp (NH) p and fluoride-induced alterations suggestive of subunit dissociation upon activation by these ligands (23). The really hard work fell to Paul Sternweis and John Northup, who together undertook the task of purification. The good luck of  $G_s$  was its revelation by mutation in S49 cells and the existence of an easy assay for the protein by activation of adenylyl cyclase. The bad luck, unknown at the time, was that  $G_s$  is among the least abundant of the G proteins. Nevertheless, perseverance (by all involved) and skill (by those doing the experiments) paid off, and  $G_s$ , with its unsuspected 35-kDa  $\beta$  subunit, finally emerged as a homogeneous guanine nucleotide binding protein, capable of activating adenylyl cyclase in its Gpp(NH)p or fluoride activated forms (Fig. 4) [24, 25]. A third, 8-kDa ( $\gamma$ ) subunit went unnoticed at the time.

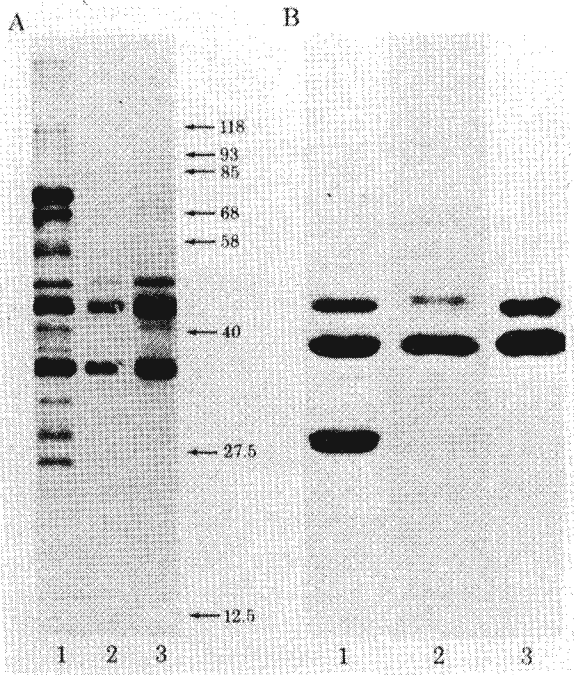

Fig. 4. A: Polyacrylamide gel electrophoresis of purified fractions of  $G_s$ . (1) Protein from an intermediate step of purification. (2) and (3) Purified protein, 3  $\mu$ g and 8  $\mu$ g, respectively. B: Labeling of purified  $G_s$  with cholera toxin and [ $^{32}$ P]NAD. (1) Purified protein stained with Coomassie blue. (2) and (3) Autoradiograms of the cholera toxin-labeled protein, exposed for 16 and 48 hr, respectively. The two higher molecular weight bands in the purified preparation, both of which are labeled with cholera toxin, are alternatively spliced forms of  $G_s\alpha$ . The lower molecular weight band is the  $\beta$  subunit. Reprinted from Northup *et al.* [24], with permission.

Further studies of  $G_s$  performed shortly thereafter revealed that one equivalent of guanine nucleotide bound to the  $\alpha$  subunit of the oligomer, that activation by Gpp(NH)p or fluoride was in fact accompanied by subunit dissociation, and that the resolved Gpp(NH)p-bound  $\alpha$  subunit was necessary

and sufficient for activation of adenylyl cyclase (Fig. 5) [26, 27]. Additional work on the mechanism of activation of  $G_s$  by fluoride provided surprises and even amusement. The effect of fluoride, observable when experiments were performed in glass test tubes or in the presence of components of the adenylyl cyclase assay (i.e., ATP), was lost in the absence of ATP when experiments were done in plastic test tubes [28, 29]. Another mystery factor was skillfully pursued by Paul Sternweis, who purified the coactivator from both ATP and from aqueous extracts of disposable glass test tubes. A metal seemed to be involved, and neutron-activation analysis revealed  $Al^{3+}$  as the culprit [29]. The significance and value of that observation has become particularly apparent a decade later (see below).

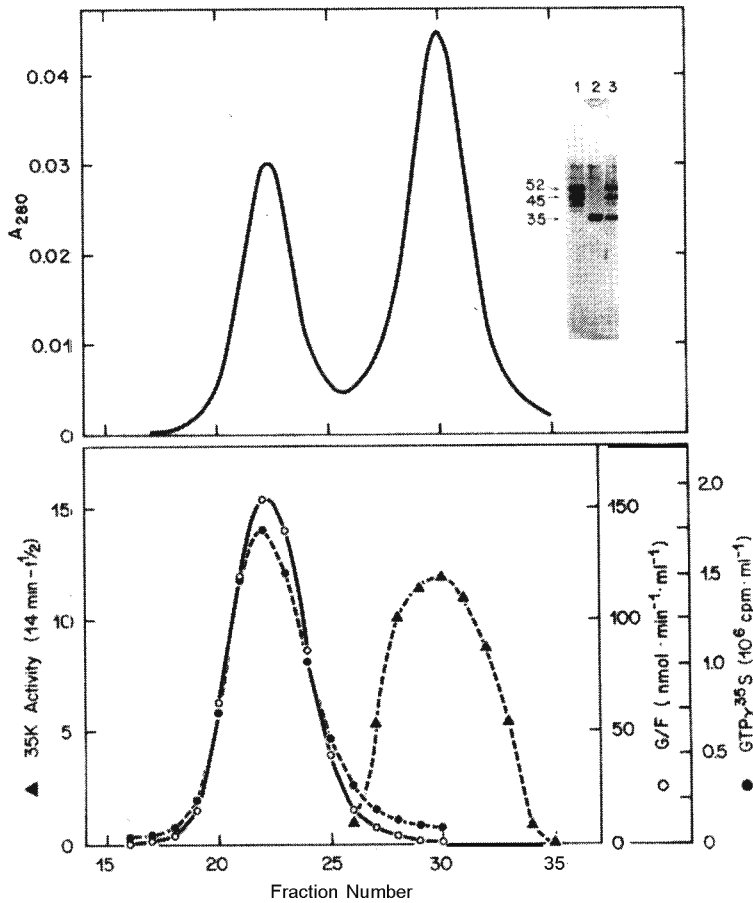

Fig. 5. Resolution of the subunits of  $G_s$  by gel filtration. Purified  $G_s$  was activated by incubation with  $[^{35}S]GTP\gamma S$ . After removal of free nucleotide, the protein was subjected to high performance gel filtration. The top panel shows the absorbance of the eluted protein. The inset shows the silver staining pattern for SDS PAGE gels of the pooled peaks of protein (lane 1 = first peak, lane 2 = second peak) and of the protein applied (lane 3). The lower panel shows the activities assayed. G/F ( $G_s$  activity (o) is quantified by activation of adenylyl cyclase.  $[^{35}S]GTP\gamma S$  (•) indicates high-affinity binding of the radioactive nucleotide. 35K Activity ( $\blacktriangle$ ) is a measure of the activity of the  $\beta\gamma$  subunit complex. Nucleotide binding activity and the capacity to activate adenylyl cyclase were exclusively associated with the resolved  $\alpha$  subunit of  $G_s$ , which dissociated from  $\beta\gamma$  on activation with  $GTP\gamma S$ . Reprinted from Northup *et al.* (27), with permission.



An interesting side activity at this time was study of the ADP-ribosylation of Gs by cholera toxin. That this occurred was very strongly implied by the work of Gill [30], Vaughan [31], and Bourne [32] and was proven with purification of the protein. However, as purification proceeded, the capacity of cholera toxin to ADP-ribosylate Gs was lost. This could be restored by addition of a protein factor [33] that was eventually purified, named ADP-ribosylation factor or ARF, and found to be a low-molecular-weight GTP binding protein [34, 35]. ARF is, of course, now leading a happy existence as an important regulator of protein trafficking [36] and as an activator of phospholipase D [37]. Its association with cholera toxin and/or G<sub>s</sub> remains to be explained.

Work in Japan in the late 1970's and early 1980's by Michio Ui and his colleagues resulted in characterization of islet-activating protein (IAP) – a toxin from *Bordetella pertussis*. Treatment of cells or membranes with this toxin resulted in loss of hormonal inhibition of adenylyl cyclase (and in some cases enhancement of hormonal stimulation of the enzyme) [38]. Coincidentally, the toxin appeared to catalyze the incorporation of the ADP-ribosyl moiety of NAD into a 41-kDa membrane protein [39]. The parallel with cholera toxin was remarkable. Toshiaki Katada, Professor Ui's student, applied for a postdoctoral position in my lab and was quickly accepted. As Gary Bokoch, another newly arrived postdoc, and Katada began to work with Professor Ui's toxin, John Northup realized that he had frequently been plagued with a 41-kDa contaminant during purification of G<sub>s</sub>. He even had fractions in the freezer that were enriched in this contaminant; moral: never throw anything away! (This contaminant can be seen in Fig. 4, above, from the original purification paper.) The obvious experiment worked beautifully on the first try; Northup's contaminant was a superb substrate for ADP-ribosylation by IAP. Our relatively tortuous experience with the purification of Gs then paid off, and purification of "the" IAP substrate proceeded quickly [40], aided by the fact that it is substantially more abundant than G<sub>s</sub>. The hypothesis that the IAP substrate represented G<sub>i</sub>, a homologous G protein responsible for inhibition of adenylyl cyclase, was obvious, and its validity was established a year later with thorough characterization of G<sub>i</sub> (41 – 44). Nevertheless, the actual mechanisms (plural intended) of inhibition of adenylyl cyclase by G<sub>i</sub> remained elusive.

Throughout much of this time, Bitensky, who had detected a light-activated cyclic GMP phosphodiesterase in the retina [45], called attention to parallels between the visual transduction pathway and hormone-sensitive adenylyl cyclases. Particularly notable were descriptions of a light-activated GTPase [46] and a guanine nucleotide requirement for activation of the phosphodiesterase. These observations led to purification of transducin (G<sub>t</sub>) [47, 48] and appreciation that G<sub>s</sub>, G<sub>i</sub>, and G<sub>t</sub> represented a family of structurally homologous guanine nucleotide binding proteins with related  $\alpha$  subunits and very similar (or identical)  $\beta$  subunits [49] (Fig. 6). The existence of the  $\gamma$  subunit of the transducin heterotrimer was recognized early because of its great abundance. Poor avidity for stain delayed its recognition as a component of G<sub>s</sub> and G<sub>i</sub> [41,50].

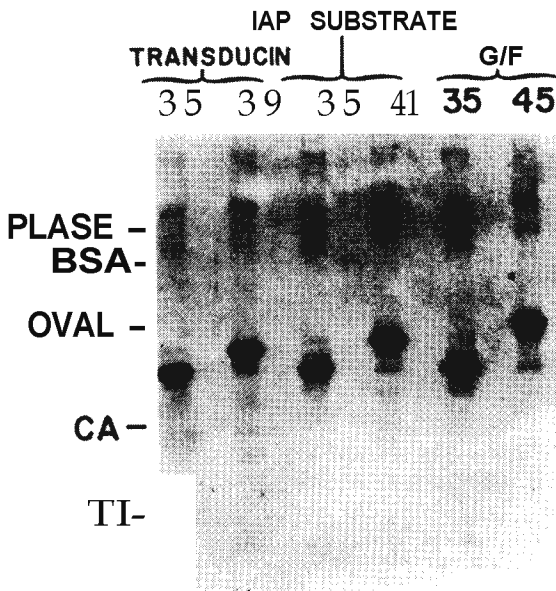

Fig. 6. Electrophoretic profile of the purified subunits of transducin ( $G_T$ ), the IAP substrate ( $G_I$ ), and G/F ( $G_S$ ). The  $\alpha$  subunits of the three G proteins have different molecular weights, while the  $\beta$  subunits appeared to be the same. Peptide mapping and analysis of amino acid compositions of the subunits indicated that the  $\alpha$  subunits were distinct but related, while the  $\beta$  subunits were very similar or identical. Reprinted from Manning and Gilman [49], with permission.

For a brief period of time in the early 1980's it seemed that things might calm down. Guanine nucleotide-mediated stimulation and inhibition of adenylyl cyclase was in the hands of  $G_S$  and  $G_T$ , while transducin explained the observations in the visual system. In collaboration with Ross, we were able to observe hormonal stimulation of adenylyl cyclase using three purified proteins – the  $\beta$ -adrenergic receptor,  $G_S$ , and adenylyl cyclase – reconstituted into phospholipid vesicles [51]. What more was there? Major clues came quickly. Paul Sternweis [52], now independently, and Eva Neer [53] discovered  $G_o$  as a startlingly abundant protein in brain; Fain (54) and Gomperts [55] observed hormone- and GTP-dependent stimulation of inositol trisphosphate synthesis; amino acid sequence homologies were detected between signal-transducing G proteins and the p21<sup>ras</sup> gene products (56); and the cloners arrived (57, 58). It was clearly time to add some new technology to the repertoire and welcome many new people to the party.

## G PROTEINS FROM PHEROMONES TO PHOTONS

It now seems appropriate to abandon the historical, story-telling approach and attempt to describe the current level of understanding of G protein-mediated transmembrane signaling. It has become abundantly clear, particularly over the past decade, that this relatively large family of heterotrimeric GTP-binding and hydrolyzing proteins plays an essential transducing role

in linking hundreds of cell surface receptors to effector proteins at the plasma membrane. These systems are widely utilized in nature, controlling processes ranging from mating in yeast to cognition in man. Receptors that activate G proteins are correspondingly diverse and encompass proteins that interact with hormones, neurotransmitters, autacoids, odorants, tastants, pheromones, and photons. Several reviews of this area are recommended {59 – 70} and should also be consulted for references to the original literature.

**Overview of G Protein Function and Structure.** Although G proteins are structural heterotrimers, they function as dissociable dimers. The  $\beta$  and  $\gamma$  subunits exist as tightly associated complexes that function as a unit. The identity of the  $\alpha$  subunit is currently used to define a given G protein oligomer. Although a number of different  $\beta\gamma$  subunit complexes can apparently associate fruitfully and promiscuously with a variety of  $\alpha$  subunits, it is unknown to what extent this occurs *in vivo*.

Sixteen distinct genes encode G protein  $\alpha$  subunits in mammals; 20 or more proteins are synthesized, including the products that arise as a result of alternative splicing of mRNA. The commonly recognized subclassification of the  $\alpha$  subunit family is based on structural relationships, but this scheme does reasonable justice to functional relationships as well {66} (Fig. 7). Four subfamilies are usually discussed: (1) the small  $G_s$  group ( $G_s$  and  $G_{off}$ ), best recognized as activators of adenylyl cyclases; (2) the large and functionally diverse  $G_i$  group, whose members are pertussis toxin substrates with one exception ( $G_z$ ); (3) the  $G_q$  group, activators of the several isoforms of phospholipase C $\beta$ ; and (4) the most recently recognized  $G_{12}$  group, whose functions are unknown. There are five known genes encoding  $\beta$  subunits and six for  $\gamma$ s. If all possible combinations of  $\alpha$ ,  $\beta$ , and  $\gamma$  were allowed, we would need to consider at least 600 G protein oligomers. Although some combinations of  $\beta$  and  $\gamma$  appear to be forbidden and there are some preferences of  $\alpha$ 's for specific  $\beta\gamma$  dimers, the number is still likely to be very large.

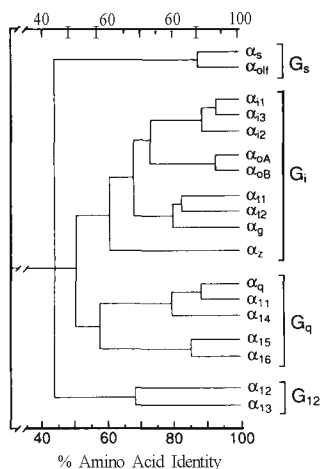

Fig. 7. Sequence relationships between mammalian  $G_\alpha$  subunits and family groupings. Modified, with permission, from {66} and {65}.

Each G protein  $\alpha$  subunit has a single high-affinity binding site for guanine nucleotide. The GDP-bound form of  $\alpha$  is relatively inactive and has high affinity for  $\beta\gamma$ . Thus, GDP- $\alpha\beta\gamma$  constitutes the inactive oligomer. Receptor-catalyzed guanine nucleotide exchange results in formation of GTP- $\alpha$ , and resultant conformational changes cause dissociation of  $\alpha$  from  $\beta\gamma$  (see Fig. 8). Two regulators of downstream effectors, GTP- $\alpha$  and  $\beta\gamma$  are thus liberated. G protein  $\alpha$  subunits are themselves enzymes, albeit poor ones, with intrinsic GTPase activity. After a period of time characteristic of individual  $\alpha$  subunits, GTP is hydrolyzed to GDP, subunits associate, and the basal state is restored. G proteins thus function as switches and timers. The high affinity of  $\alpha$  (and particularly of the oligomer) for GDP holds the switch off; nucleotide exchange turns the switch on; hydrolysis of GTP turns it off again with a characteristic delay (seconds to perhaps minutes) as a result of slow catalysis; this constitutes the timer, which is an important element of signal amplification.

### G PROTEIN ACTIVATION/ DEACTIVATION CYCLE

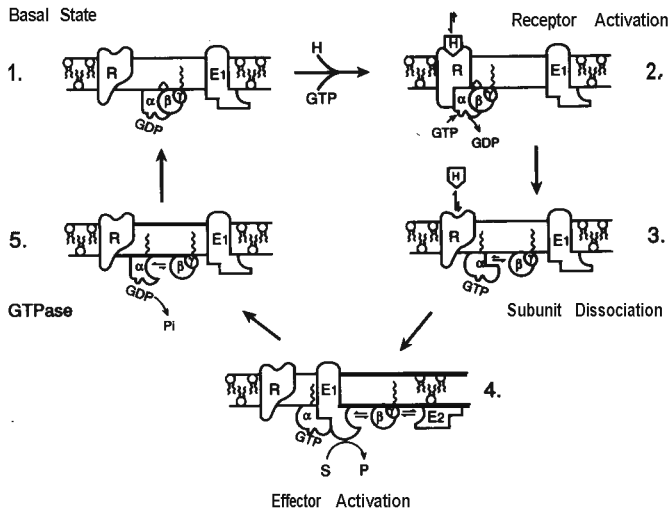

Fig. 8. G-protein-mediated transmembrane signalling. In the basal state (1) G proteins exist as heterotrimers with GDP bound tightly to the  $\alpha$  subunit; the hormone receptor (R) is unoccupied and the effector (E) is unregulated. Upon hormone binding and receptor activation (2), the receptor interacts with the heterotrimer to promote a conformational change and dissociation of GDP from the guanine nucleotide binding site; at normal cellular concentrations of guanine nucleotides, GTP fills the site immediately. (Under experimental conditions where GTP is absent, the hormone has high affinity for the receptor and the H-R-G-protein complex is stable.) Binding of GTP to  $G_{\alpha}$  (3) induces a conformational change with two consequences. First, the G protein dissociates from the H-R complex, reducing the affinity of hormone for receptor and, in turn, freeing the receptor for another liaison with a neighboring quiescent G protein. Second, GTP binding also reduces the affinity of  $G_{\alpha}$  for  $G_{\beta\gamma}$  and subunit dissociation occurs. This frees  $G_{\alpha}$ -GTP to fulfill its primary role as a regulator of effectors (4). At least in some systems, the free  $G_{\beta\gamma}$  complex also interacts directly with effectors (E<sub>1</sub>) and modulates the activity of the active complex, or it acts independently at distinct effectors (E<sub>2</sub>).  $G_{\alpha}$  possesses an intrinsic GTPase activity (5). The rate of this GTPase determines the lifetime of the active species and the associated physiological response. The  $G_{\alpha}$ -catalyzed hydrolysis of GTP leaves GDP in the binding site and causes dissociation and deactivation of the active complex.  $G_{\alpha}$ -GDP has high affinity for  $G_{\beta\gamma}$ ; subsequent reassociation of  $G_{\alpha}$ -GDP with  $G_{\beta\gamma}$  returns the system to the basal state (1). Reprinted from Helper and Gilman [68], with permission.

G protein subunits are subjected to a number of covalent modifications, both physiologically and pathologically. Lipid covalent modifications are particularly evident. Members of the  $G_i$  subfamily are myristoylated, with the C14 fatty acid incorporated in amide linkage to amino-terminal glycine residues (71 – 73). This modification is an important determinant of the affinity of these  $\alpha$  subunits for  $\beta\gamma$  and of the affinity of the  $G_{i\alpha}$ 's for adenylyl cyclase (see below) (74, 75). All  $\alpha$  subunits with the exception of  $G_{t\alpha}$  are palmitoylated, in some cases doubly so, and the C16 fatty acid is bound in thioester linkage to cysteine residues near the amino terminus (76). In the case of members of the  $G_i$  family, the palmitoylated cysteine residue is immediately adjacent to the myristoylated glycine. While myristoylation presumably occurs cotranslationally and the modification is irreversible, palmitate is incorporated posttranslationally and the bound fatty acid turns over relatively rapidly. Of particular interest, turnover of palmitate is a receptor-regulated phenomenon, with control apparently exerted at the level of removal of palmitate from the  $\alpha$  subunit (77, 78). The significance of this phenomenon is not yet fully appreciated, but it could represent part of a pathway for attenuation of transmembrane signaling. Finally, for the lipids,  $\gamma$  subunits contain typical CAAX boxes at their carboxyl termini and are prenylated; the  $\gamma_1$  subunit, found in the retina, is farnesylated (79), while the other  $\gamma$ 's appear to be geranylgeranylated (80, 81). Although prenylation is not essential for the formation of high-affinity  $\beta\gamma$  dimers, it is crucial for the interactions of  $\beta\gamma$  with  $\alpha$  and with at least certain effectors (e.g., adenylyl cyclases) (82). All of the lipid modifications may play important roles in localization of G protein subunits to membranes, although the mechanisms that dictate the specificities of these protein-membrane interactions remain to be discovered. We suspect that  $G_{s\alpha}$  contains an as yet unidentified covalent modification. The natural protein (purified from liver or brain) has a substantially higher affinity for adenylyl cyclase than does recombinant  $G_{s\alpha}$  synthesized in bacteria (83).

ADP-ribosylation of G protein  $\alpha$  subunits by bacterial toxins is a particularly interesting, irreversible covalent modification of pathological significance. The diarrheagenic enterotoxin produced by *Vibrio cholerae* and the heat labile toxin synthesized by certain strains of *E. coli* are ADP-ribosyltransferases with great specificity for  $G_{s\alpha}$ . NAD is the donor of the ADP-ribosyl moiety, which is attached to an active site arginine residue of the substrate [84]. The resultant inhibition of the GTPase activity of  $G_{s\alpha}$  causes persistent activation of both  $G_{s\alpha}$  and adenylyl cyclase. Diarrhea is the dominant sign of disease because of the local, enteric nature of the infection. A toxin (islet-activating protein) produced by *Bordetella pertussis* catalyzes ADP-ribosylation of a cysteine residue near the carboxyl-terminus of members of the  $G_i$  family of  $\alpha$  subunits [85]. This results in inhibition of interactions between G proteins and receptors, effectively blocking the affected pathways, including those that cause inhibition of adenylyl cyclase. As a sidelight, it is interesting to note that other microorganisms have developed different strategies for elevation of host cell concentrations of cyclic AMP. A toxin elaborated by

*Bacillus anthracis* and a distinct *Bordetella pertussis* toxin are themselves calmodulin-activated adenylyl cyclases that permeate mammalian cells.

High-resolution crystal structures of two G protein  $\alpha$  subunits,  $G_{ta}$  and  $G_{i\alpha 1}$ , in different liganded states have been described recently [86 – 88]. We have been pleased to collaborate with Stephen Sprang in these efforts. The general architecture of these closely related proteins is essentially identical (Fig. 9). Each is constructed of two very distinct domains: a p21<sup>ras</sup>-like  $\alpha\beta$  domain that is flanked by a unique (to G proteins)  $\alpha$  helical domain. The two structures are connected by a pair of linker strands. Although all of the direct contacts between the protein and guanine nucleotide are formed with either the p21<sup>ras</sup>-like domain or the linker 2 peptide, the nucleotide is virtually buried in the cleft between the two major domains. It is hypothesized that receptor-mediated conformational changes sufficient to permit guanine nucleotide exchange result in substantial separation of the helical and p21<sup>ras</sup>-like structures.

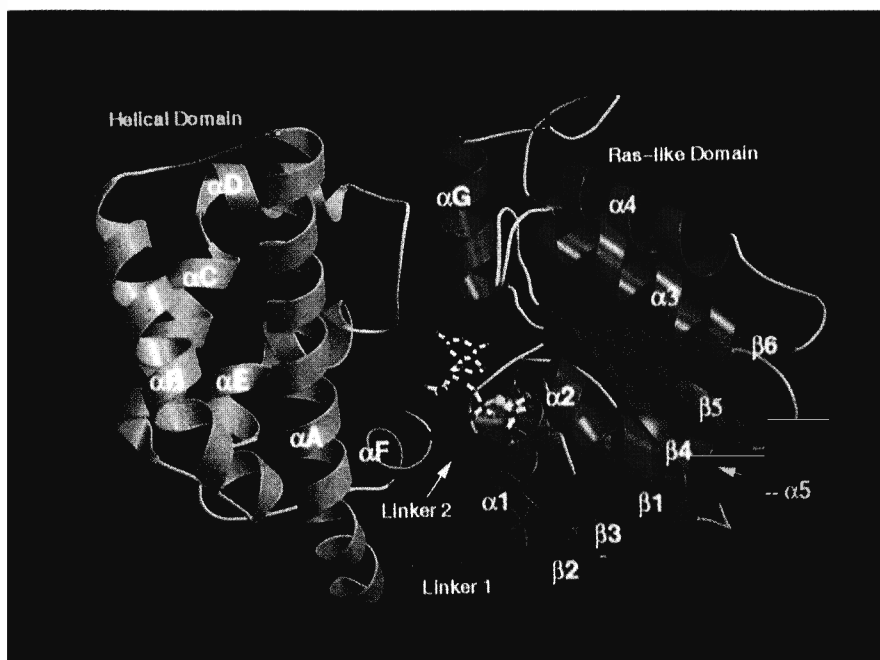

Fig. 9. Ribbon and coil schematic of  $G_{i\alpha 1}$  subunit. The helical domain is colored yellow, and the p21<sup>ras</sup>-like domain is green and cyan. Linker 1 and linker 2 strands are colored red. The  $GTP\gamma S$  is shown as a ball and stick model, and the magnesium ion is depicted as a magenta sphere. Secondary structure elements are labeled. The red N and C mark the positions of the first ordered residues at the amino and carboxy termini of the molecule. Reprinted from Coleman et al. [88], with permission.

Despite the existence of several superb crystal structures of p21<sup>ras</sup> proteins and of GTPase-deficient mutants of p21<sup>ras</sup>, it has been difficult to deduce the mechanism of GTP hydrolysis, perhaps in large part because the proteins are such poor catalysts in the absence of activators (GTPase activating proteins or GAPs). The same is true of the structures of the  $GTP\gamma S$ -bound forms of  $G_{t\alpha}$  and  $G_{i\alpha 1}$ . Happily, however, the  $AlF_4^-$ -bound conformations of these pro-

teins are more illuminating. As noted above,  $\text{Al}^{3+}$  was unexpectedly found to be a cofactor necessary for activation of G proteins by F-, and it had been deduced that  $\text{AlF}_4^-$  probably bound to  $\text{G}_\alpha$  proteins in proximity to GDP, mimicking the  $\gamma$ -phosphoryl moiety of GTP (29, 89, 90). The X-ray structure revealed this hypothesis to be nearly correct [88]. However, rather than simply mimicking GTP,  $\text{GDP-AlF}_4^-$  appears to be acting as a transition-state analog, revealing critical roles played by active-site amino acid residues.

Two residues,  $\text{Arg}^{178}$  ( $\text{G}_{i\alpha 1}$  numbering) and  $\text{Gln}^{204}$ , had been implicated in catalysis as the result of isolation or construction of GTPase-deficient proteins with mutations at these sites (91 - 94). In addition, this Arg residue corresponds to the Arg in  $\text{G}_{s\alpha}$  that is ADP-ribosylated by cholera toxin, and the Gln corresponds to  $\text{Gln}_{61}$  in  $\text{p21}^{\text{ras}}$ , a residue known to be critical for catalysis. (There is no homolog of  $\text{Arg}^{178}$  in  $\text{p21}^{\text{ras}}$   $\text{Arg}^{178}$  is in the linker 2 peptide.)

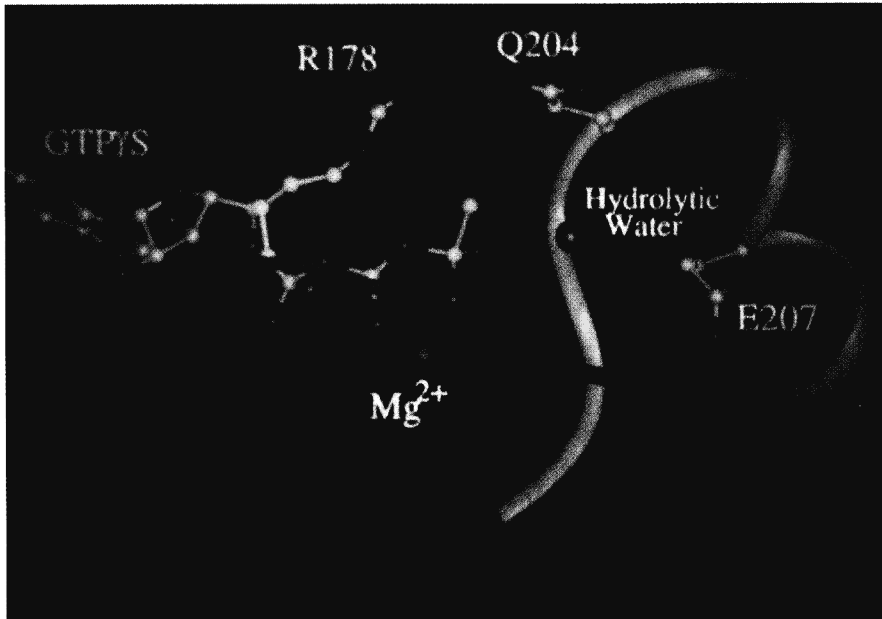

Fig. 10. A schematic of the active site in the  $\text{GTP}\gamma\text{S-G}_{i\alpha 1}$  complex, showing the disposition of  $\text{Arg}^{178}$  and  $\text{Gln}^{204}$ ; these residues are not within hydrogen bonding distance of the nucleotide. The putative water nucleophile is positioned 3.85 Å from the  $\gamma$ phosphorus trans axial to the  $\beta_1$  bridging phosphate oxygen atom. The  $\beta 1 - \alpha 1$  loop is colored green, the  $\beta 2 - \alpha 3$  switch peptide yellow, and the linker 2 strand is blue.

Rearrangement of the positions of these two residues in the  $\text{GDP-AlF}_4^-$  structure (relative to their positions in the  $\text{GTP}\gamma\text{S}$ -bound protein) reveals their roles in catalysis (Fig. 10).  $\text{Gln}^{204}$  appears to be stabilizing and orienting the hydrolytic water molecule in the trigonal-bipyramidal transition state, while  $\text{Arg}^{178}$  stabilizes the negative charge at the equatorial oxygen atoms of the pentacoordinate phosphate intermediate. Since this Arg residue is unique to  $\text{G}_\alpha$  proteins, its presence may explain the higher hydrolytic activity of  $\text{G}_\alpha$  proteins relative to those of members of the  $\text{p21}^{\text{ras}}$  family.

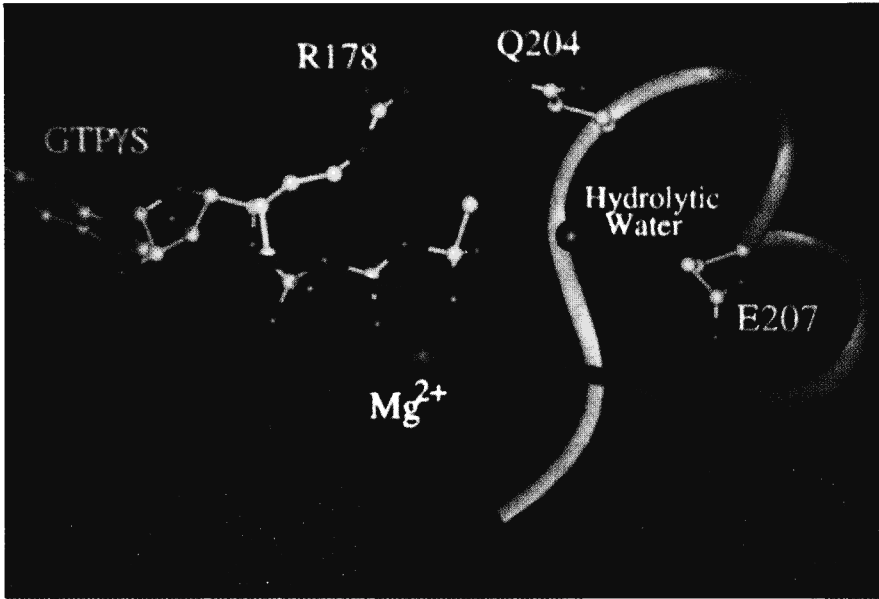

Fig. 10. B: The  $\text{GDP}\cdot\text{AlF}_4^-$  complex shown from the same perspective. Arg<sup>178</sup> and Gln<sup>204</sup> have rotated to contact the  $\text{AlF}_4^-$  cluster, and the nucleophilic water has moved into the ligand field of the aluminum ion.

Hydrolysis of GTP by  $G_{i\alpha 1}$  is accompanied by relaxation of both the linker 2 strand and a twenty-residue segment that contains Gln<sup>204</sup>. The loss of any ordered conformation in these residues (which are invisible in the electron density map) accounts for alterations in properties known to be characteristic of the GDP-bound form of the protein: loss of the  $\text{Mg}^{2+}$  binding site, a somewhat reduced affinity for guanine nucleotide, enhanced susceptibility to proteolysis in this region, and quenching of tryptophan fluorescence.

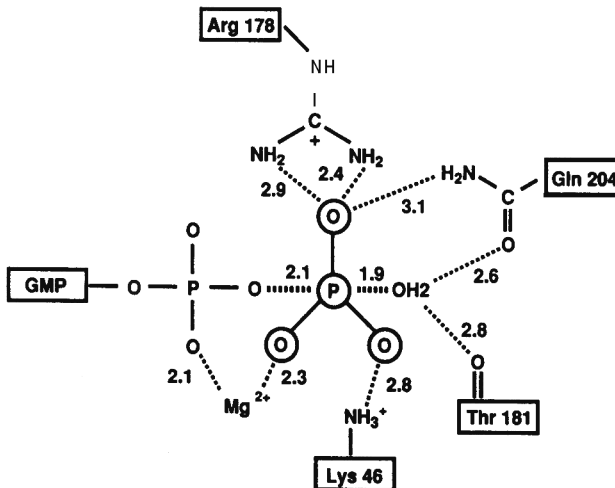

Fig. 10. C: Model of the active site of  $G_{i\alpha 1}$  at the transition state of the phosphorolysis reaction, based on the structure of the  $\text{GDP}\cdot\text{AlF}_4^-$  complex. Reprinted from Coleman et al. (88), with permission.



A surprising consequence of GTP hydrolysis is the assembly of the amino and carboxyl termini into a distinct, organized  $\alpha$ -helical domain. This structural change occurs nearly 30 Å from the catalytic site, and it is difficult to discern an intramolecular pathway of conformational transition between these sites. Even more surprising is the discovery that the newly formed domain forms an exceedingly complementary and extensive packing interface with the  $\alpha$ -helical domain and the linker 2 strand of the neighboring molecule in the crystal lattice (Fig. 11). Thus, the transmission of structural changes between the GTP binding site and the amino and carboxyl termini (which form part of the presumptive binding surface for the  $\beta\gamma$  subunit complex) might be by means of intermolecular contacts [95]. Interestingly, these observations could be pertinent to recent speculations by Rodbell on the possibility of G protein oligomerization [96].

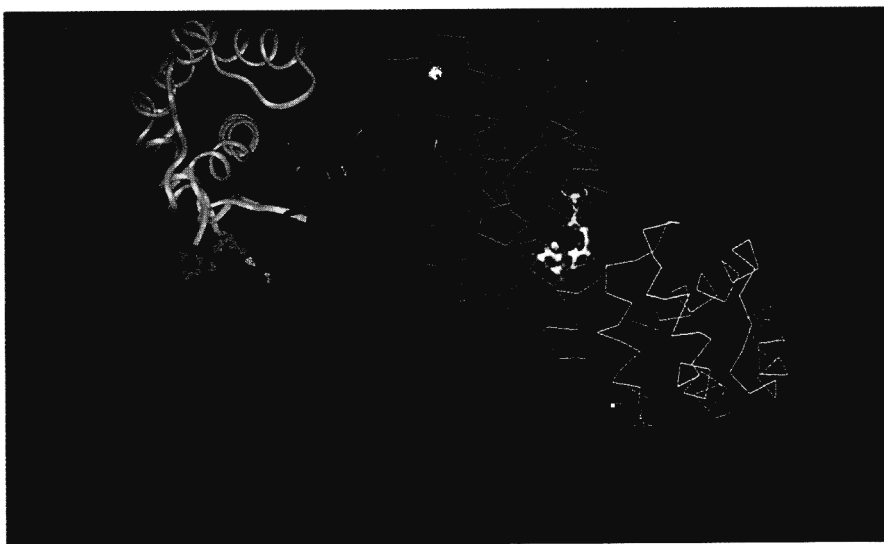

Fig. 11 Symmetry-related molecules of GDP-G<sub>iol</sub> form a helical array in the crystalline state. The carboxyl- and amino-terminal amino acid residues of G<sub>iol</sub> are disordered in the GTP complex but fold into a discrete protein microdomain comprising nearly 40 residues upon hydrolysis of the nucleoside triphosphate. A phosphate ion, which contacts three arginine residues from the amino terminus and lysine 180 from the linker-2 strand, may act as a nucleation center for the microdomain. (A sulfate ion serves this role in crystals of GDP-G<sub>iol</sub>.) This microdomain forms an extensive and complementary interface with the  $\alpha$ -helical domain and the linker-2 strand of the neighboring molecule. The contact buries more than 1800 Å<sup>2</sup> of solvent-accessible surface, an area equivalent to that encompassed by many protein antigen-immunoglobulin complexes.

### Summary of the Functions of Individual G Protein Subunits.

**$\alpha$ Subunits (Table 1).** Almost all known G protein  $\alpha$  subunits and many distinct  $\beta\gamma$  subunit complexes have been purified to homogeneity from tissue sources or purified after expression in heterologous systems (either *E. coli* or Sf9 cells). Properties of several subunits have also been inferred by application of new wave biochemistry – experiments performed “*in transfecto*”. Each system has advantages and disadvantages. While the *E. coli*-derived proteins may be missing certain covalent modifications (although myristoylation can be accom-

plished by coexpression of protein N-myristoyl transferase), they have the distinct advantage of being unambiguously free of other G protein subunits. This can be difficult to prove with G proteins isolated from other sources.

Table 1. Properties of Mammalian G Protein  $\alpha$  Subunits

Family/ Subunit	M <sub>r</sub> (kDa x 10 <sup>-3</sup> )	% A.A. Identity <sup>a</sup>	Toxin <sup>b</sup>	Lipid <sup>c</sup>	Tissue Distribution	Representative Receptors <sup>d</sup>	Effector/ Role
<b>G<sub>s</sub></b>							
$\alpha_{s(s)}$ (2X) <sup>e</sup>	44.2	100	CT	P	Ubiquitous	$\beta$ AR <sup>e</sup> ,	$\uparrow$ Adenylyl cyclase
$\alpha_{s(l)}$ (2X) <sup>e</sup>	45.7		CT	P	Ubiquitous	Glucagon, TSH, others	$\uparrow$ Ca <sup>2+</sup> channels $\downarrow$ Na <sup>+</sup> channels
$\alpha_{olf}$	44.7	88	CT	P?	Olfactory neuroepi- thelium	Odorant	$\uparrow$ Adenylyl cyclase
<b>G<sub>i</sub></b>							
$\alpha_{i1}$	40.3	100	PT	M, P	Nearly ubi- quitous		$\downarrow$ Adenylyl cyclase
$\alpha_{i2}$	40.5	88	PT	M, P	Ubiquitous	M <sub>2</sub> Cho, $\alpha_2$ AR others	$\uparrow$ K <sup>+</sup> channels (?)
$\alpha_{i3}$	40.5	94	PT	M, P	Nearly ubi- quitous		$\uparrow$ Phospholipase A <sub>2</sub> (?)
$\alpha_{oA}$	40.0	73	PT	M, P	Brain, others	Met-Enk,	$\downarrow$ Ca <sup>2+</sup> channels
$\alpha_{oB}$	40.1	73	PT	M, P	Brain, others	$\alpha_2$ AR, others	$\downarrow$ Adenylyl cyclase others
$\alpha_{i1}$	40.0	68	CT, PT	M	Retinal rods	Rhodopsin	$\uparrow$ cGMP-specific phosphodiesterase
$\alpha_{i2}$	40.1	68	CT, PT	M	Retinal cones	Cone opsins	
$\alpha_s$	40.5	67	CT (?), PX		Taste buds	Taste (?)	
$\alpha_\gamma$	40.9	60		M, P	Brain, ad- renal, platelets	M <sub>2</sub> Cho (?), others (?)	$\downarrow$ Adenylyl cyclase other, (?)
<b>G<sub>q</sub></b>							
$\alpha_q$	42	100		P	Nearly ubi- citous	M <sub>1</sub> Cho, $\alpha_1$ AR, others	
$\alpha_{i1}$	42	88		P	Nearly ubi- citous		
$\alpha_{i4}$	41.5	79		P	Lung, kid- ney, liver	C5a, IL-8, others	$\uparrow$ Phospholipase C- B's, others (?)
$\alpha_{i5}$	43	57		P?	B-cells, myeloid cells	IL-8, others (?)	
$\alpha_{i6}$	43.5	58		P	T-cells, mye- loid cells	IL-8, others (?)	
<b>G<sub>12</sub></b>							
$\alpha_{i2}$	44	100		P	Ubiquitous	>	?
$\alpha_{i3}$	44	67		P	Ubiquitous	>	?

Footnotes: Table 1.

a. % Amino acid identity: comparison is with the first-listed member of each family

b. Cholera toxin (CT) and pertussis toxin (PT) catalyze the ADP-ribosylation of an arginine residue (CT) and a cysteine residue (PT), respectively, of the indicated  $\alpha$  subunits.

c. Lipid modifications: The indicated G<sub>s</sub> subunits are covalently modified at or near the amino terminus on cysteine residues by S-palmitoylation (P) and/or glycine residues by N-myristoylation (M).

d. Receptor abbreviations:  $\beta$ AR,  $\beta$ -adrenergic; M<sub>2</sub>Cho, M<sub>2</sub>-muscarinic cholinergic;  $\alpha_2$ AR,  $\alpha_2$ -adrenergic; met-enk, met-enkephalin; M<sub>1</sub>Cho, M<sub>1</sub>-muscarinic cholinergic;  $\alpha_1$ AR,  $\alpha_1$ -adrenergic.

e. Splice variants.  $\alpha_{s(s)}$ =short forms of a  $\alpha_s$  and  $\alpha_{s(l)}$ =long forms of  $\alpha_s$ .

The members of the  $G_{s\alpha}$  subfamily ( $\alpha_s, \alpha_{olf}$ ) activate various adenylyl cyclases, and they do so by direct interactions with these proteins. All known isoforms of membrane-bound mammalian adenylyl cyclase are activated by  $G_{s\alpha}$ .  $G_{s\alpha}$  is expressed as four distinct polypeptides (+/- residues encoded in exon 3; +/- a serine residue at the splice junction) as a result of alternative splicing of a single precursor mRNA, but these variants have not been well distinguished functionally [97 - 99]. The  $\alpha$  subunit of  $G_{olf}$  is expressed predominantly in olfactory neuroepithelium, where it presumably couples odorant receptors with a largely olfactory-specific isoform of adenylyl cyclase (type III) [100]. Purified  $G_{s\alpha}$  also activates dihydropyridine-sensitive, voltage-gated  $Ca^{2+}$  channels in patches excised from skeletal and cardiac muscle (101) and inhibits cardiac  $Na^+$  channels (102). The physiological significance of these last two effects is difficult to judge.  $G_s$  is activated by receptors that stimulate adenylyl cyclase activity; B-adrenergic receptors are prototypical.

Members of the  $G_i$  subfamily were first encountered as retinal transducins and then as substrates for islet-activating protein. The two isoforms of transducin are selectively expressed in retinal rods and cones [103]. They are activated by photolyzed rhodopsin or the cone opsins, and each stimulates a cyclic GMP-specific phosphodiesterase, resulting in lowered intracellular concentrations of cyclic GMP on illumination. A transducin-like G protein, gusducin, is expressed selectively in taste buds (104). The relationship of gusducin to the transducins is sufficiently close that a cyclic nucleotide phosphodiesterase is hypothesized to be the effector in a pathway mediating response to certain tastants.

Three closely related genes encode  $G_{i\alpha 1, 2, \text{ and } 3}$ . These proteins are functionally very similar *in vitro*, although they differ in both their cellular and subcellular distribution. Demonstration of the direct involvement of these  $\alpha$  subunits as inhibitors of adenylyl cyclases was long delayed for several technical reasons, including a requirement for comparatively high concentrations, the need for myristoylation of the  $\alpha$  subunit, and differential responses of different isoforms of adenylyl cyclase (75, 105). This role is now well established. Although the  $G_{i\alpha}$  proteins were originally thought to activate  $K^+$  channels in cardiac myocytes and neural tissue [106], their role in this pathway is now more controversial and may be secondary to that played by the  $\beta\gamma$  subunit complex [107]. Evidence has also accumulated for a role of at least certain  $G_{i\alpha}$  proteins in membrane trafficking [108 - 110]. Participation of these proteins in such apparently distinct cellular pathways is confusing.

$G_{z\alpha}$  differs substantially from the  $G_{i\alpha}$  proteins, but it also inhibits adenylyl cyclase activity in transfected cells (111) or *in vitro* (112). Notably,  $G_{z\alpha}$  is not a substrate for pertussis toxin and has a very slow rate of GTP hydrolysis [113].

As mentioned above, the discovery of  $G_o$  was an eye-opener because of its abundance in brain (1 - 2% of brain membrane protein) and apparent lack of involvement with known guanine nucleotide-regulated systems. Although  $G_{o\alpha}$  appears to play a major role as an inhibitor of voltage-sensitive  $Ca^{2+}$  channels [114], I assume it has other extremely important roles. Hints are suppli-

ed by its high concentration in neural growth cones [115] and apparent interactions with GAP-43, a  $\text{Ca}^{2+}$  - binding protein that is also concentrated in these structures (116).

Compelling evidence for regulation of phosphoinositide-specific phospholipase C activities was in hand well before the relevant G proteins could be identified (54, 55). This is a pertussis toxin-insensitive process in most cells, and the PCR-based cloning of members of the  $G_{q\alpha}$  subfamily provided candidates for this role [117]. Nearly simultaneously, G proteins that serve this function were identified by classical reconstitutive techniques (118, 119) and by purification of novel  $\alpha$  subunits using clever subunit affinity and exchange techniques [120]. All three paths merged with the identification of  $G_{q\alpha}$  and then  $G_{11\alpha}$ ,  $G_{14\alpha}$ , and  $G_{18\alpha}$  as activators of the various isoforms of phospholipase CB. Purification of the relevant proteins proved that interactions of  $G_{q\alpha}$  family members with the phospholipases are direct, and these appear to occur at carboxyl-terminal domains of the enzymes. Particularly interesting is the observation that the phospholipase C $\beta$ 's act as GAPs or GTPase-activating proteins towards  $G_{q\alpha}$  (121). In the absence of the effector, the  $k_{\text{cat}}$  for hydrolysis of GTP by these proteins is very slow, but it is increased over 50-fold by the effector. The simplest interpretation of this effect is that phospholipase C $\beta$  should block its own activation. However, kinetic analyses of these interactions suggest that receptor,  $G_q$ ; and the phospholipase associate in a complex that binds and hydrolyzes GTP rapidly, such that there is substantial steady-state activation of phospholipase C associated with particularly rapid responses.

The roles of  $G_{12\alpha}$  and  $G_{13\alpha}$  are unknown. Both of these proteins are structurally related to the product of the *Drosophila concertina* gene, which appears to play a role in gastrulation [122]. Transfection of NIH 3T3 cells with  $G_{12\alpha}$  cDNA results in cellular transformation [123, 124].

Table 2. Properties of Mammalian G Protein  $\beta$  and  $\gamma$  Subunits

Subunit	Mr (kDaxl <sup>a</sup> )	%A.A. Identity <sup>a</sup>	Tissue Distribution	Effector/Role
$\beta$				
$\beta_1$	37.3	100	Ubiquitous	
$\beta_2$	37.3	90	Nearly ubiquitous	Required for $G_{\alpha}$ -receptor interaction
$\beta_3$	37.2	83	Nearly ubiquitous	
$\beta_4$	37.2	89	Nearly ubiquitous	Inhibition of $G_{\alpha}$ activation
$\beta_5$	38.7	52	Brain	
				Support of agonist-induced receptor phosphorylation and desensitization
$\gamma$				$\uparrow$ or $\downarrow$ Adenylyl cyclase (isoform specific responses)
$\gamma_1$	8.4	100	Retinal rods	$\uparrow$ Phospholipase C $\beta_2$ , $\delta$ ,
$\gamma_2$	7.9	38	Brain, adrenal	
$\gamma_5$	8.5	36	Brain, testis	$\uparrow$ K <sup>+</sup> channels
$\gamma_4$	(?partial)	(34)	(Kidney, retina (?))	
$\gamma_6$	7.3	25	Ubiquitous	$\uparrow$ Phospholipase A' (?)
$\gamma_7$	7.5	35	Ubiquitous	

a. % Amino acid identity: comparison is with the first-listed member of each family.

$\beta\gamma$  **Subunits (Table 2).** General acceptance of downstream regulation of effectors by the  $\beta\gamma$  subunit complex is relatively recent {69, 70}. These subunits were first assigned less glamorous roles. The binding of GDP and  $\beta\gamma$  to  $\alpha$  is positively cooperative.  $\beta\gamma$  thus stabilizes the inactive GDP-bound form of  $\alpha$  by markedly reducing the rate of dissociation of nucleotide (125). As a result,  $\beta\gamma$  acts as a noise suppressor (126). By contrast, interactions of GTP and  $\beta\gamma$  with  $\alpha$  are negatively cooperative, and it was hypothesized that  $\beta\gamma$  could speed deactivation of  $\alpha$  and thereby cause inhibition of relevant downstream responses {127}. The significance of this possibility remains ill defined, but the eventual observation of inhibitory effects of  $G_{i\alpha}$  proteins on adenylyl cyclase has obviated the "need" for this hypothesis. Receptor-catalyzed exchange of GDP for GTP on  $G_{\alpha}$  requires  $\beta\gamma$  {128}, and  $\beta\gamma$  can act catalytically in this role. The G protein heterotrimer is thus the form that is recognized by receptor, and reassociation of subunits is a requisite for activation.

The first strong evidence for interaction of  $\beta\gamma$  with effectors came from Logothetis *et al.* {107}, who detected activation of  $K^+$  channels in cardiac atrial myocytes with  $\beta\gamma$  but not with  $G_{i\alpha}$ . Controversy about the interpretation of these observations kept  $\beta\gamma$  at least partially in the closet for a few years, despite genetic evidence that  $\beta\gamma$  was the primary mediator of downstream signaling in the pheromone response pathway of budding yeast {129}. Interesting and direct interactions between  $\beta\gamma$  and effectors such as adenylyl cyclases {130 – 132} and phospholipases {133, 134} have now been observed using simple biochemical assays that have been widely reproduced; the issue thus now seems to be settled. Effects of  $\beta\gamma$  on different adenylyl cyclases will be discussed below.

The issue of specificity among different species of  $\beta\gamma$  subunits remains vexing. Other than observations that non-retinal  $\alpha$  subunits and effectors appear to discriminate against retinal  $\beta\gamma$  ( $\beta_1\gamma_1$ ), little specificity is observed in examination of the interactions of a number of  $\beta\gamma$  subunit complexes with a variety of  $\alpha$  subunits and effectors {82, 135, 136}. These observations, made *in vitro*, fly in the face of striking observations of specificity made in intact cells by Kleuss and associates {82, 135 – 139}. Voltage-sensitive  $Ca^{2+}$  channels in GH3 cells are inhibited by both M4-muscarinic and somatostatin receptors. Selective suppression of either of the two splice variants of  $G_{o\alpha}$  with antisense oligonucleotides demonstrates that the muscarinic response depends on the expression of  $G_{o1\alpha}$  but not  $G_{o2\alpha}$  while the response to somatostatin is selectively dependent on  $G_{o2\alpha}$ . Similar suppression of individual  $\beta$  or  $\gamma$  subunits also yielded striking results, consistent with muscarinic signaling via  $\alpha_{o1}\beta_3\gamma_4$  and somatostatin signaling through  $\alpha_{o2}\beta_1\gamma_3$ . The best current guess is that this specificity is exerted at the level of receptor-G protein interactions, but demonstrations of such by reconstitution of purified components *in vitro* remains less than convincing.

## ADENYLYL CYCLASES

We have maintained our interest in adenylyl cyclases throughout the “diversion” into G proteins, although “the job” of adenylyl cyclase was for some time the domain of only one individualistic lab member. This situation changed and improved substantially in 1989.

Mammalian adenylyl cyclases are activated by forskolin, a diterpene found in the roots of the plant *Coleus forskolii*. The development of a forskolin-affinity matrix by Pfeuffer and Metzger [140] made purification of the enzyme possible, but not simple. Smigel was the first in our laboratory to purify a calmodulin-sensitive form of adenylyl cyclase from bovine brain by adapting Pfeuffer's techniques [141], and Krupinski and coworkers [142] finally purified a sufficient amount of protein to obtain amino acid sequence. With the invaluable help of Randall Reed at Johns Hopkins, whose collaborative efforts we sought because of the abundance of adenylyl cyclase in olfactory neuroepithelium, cDNA's encoding type I (by definition) adenylyl cyclase were obtained from a bovine brain library. Several labs have now contributed to the isolation of six additional full-length clones (types II – VI and VIII) by application of low-stringency hybridization and PCR techniques; all of these proteins have been expressed, and their regulatory properties are being defined [143 – 145].

Mammalian, membrane-bound adenylyl cyclases have a complex (deduced) structure that is reminiscent of a variety of transporters and channels (Fig. 12). Their topographical relationship to the P glycoprotein and the cystic fibrosis transmembrane conductance regulator is striking, although they share no amino acid sequence homologies with these proteins. A short cytoplasmic amino terminus is followed by six putative transmembrane spans (designated  $M_1$ ) and a roughly 40-kDa cytoplasmic domain ( $C_1$ ). This apparent structural unit is then repeated: a second set of six transmembrane spans ( $M_2$ ) is again followed by a second large cytoplasmic domain ( $C_2$ ). Although this structure is unique for a “simple” enzyme, its significance is elusive. I find it fascinating that the regulatory motif for adenylyl cyclases – activation by a GTP binding protein – is apparent in *Saccharomyces cerevisiae*. Although this mode of regulation is conserved from yeast to mammals, the molecular players are not. The adenylyl cyclase of *Saccharomyces* is a very large peripheral membrane protein with little resemblance to its mammalian counterpart [146]. The GTP-binding protein in yeast responsible for stimulation of cyclic AMP synthesis is the resident homolog of mammalian p21<sup>ras</sup> [147], even though yeast have heterotrimeric G proteins. Evolution works in strange ways.

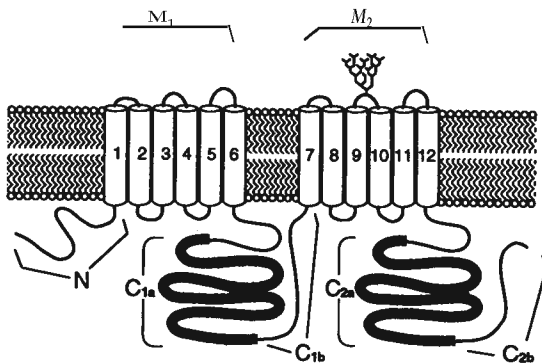

Fig. 12. Predicted topology of membrane-bound adenylyl cyclases. Cylinders represent membrane-spanning regions, while bold lines indicate regions of high amino acid similarity among all members of the family. Nomenclature is as follows: N, aminoterminal domain;  $M_1$ , first set of membrane-spanning regions;  $C_{1a}$  and  $C_{1b}$ , the first large intracellular cytoplasmic domain;  $M_2$ , second set of transmembrane spanning regions; and  $C_{2a}$  and  $C_{2b}$ , the second large intracellular domain. Reprinted from Taussig and Gilman [145], with permission.

Two regions of roughly 200 amino acid residues each ( $C_{1a}$  and  $C_{2a}$ ) are highly conserved among the mammalian adenylyl cyclases, and this relationship also extends to the topographically similar enzymes of *Drosophila* and *Dictyostelium*. The  $C_{1a}$  and  $C_{2a}$  domains are also quite similar to each other and to the catalytic domains of both membrane-bound and soluble guanylyl cyclases. These relationships indicate that one or both of these domains is a site of catalysis.

Unfortunately, it has not been possible to detect significant adenylyl cyclase activity following expression of either of these putative catalytic domains as discrete proteins; the same is true if individual halves of the molecule are expressed in Sf9 cells. Nevertheless, concurrent expression of  $M_1C_1$  and  $M_2C_2$  results in appearance of a substantial level of adenylyl cyclase activity that can be regulated characteristically by G protein subunits and, in the case of the type I enzyme, calmodulin [130]. We tentatively assume that interaction between the  $C_1$  and  $C_2$  domains is necessary for catalysis. This is consistent with the facts that both subunits of heterodimeric, soluble guanylyl cyclases are required for catalysis (each subunit contains sequences homologous to  $C_{1a}$  and  $C_{2a}$ ) [148] and that the membrane-bound guanylyl cyclases are homo-oligomers [149]. It is also interesting that point mutations in either  $C_{1a}$  or  $C_{2a}$  can impair adenylyl cyclase activity severely and that mutations in either domain can elevate the  $K_m$  for ATP. Both domains may bind ATP; both might also catalyze cyclic AMP synthesis, or one may be the dominant catalyst while the other serves a regulatory role.

**Regulation of Adenylyl Cyclases by G Protein Subunits.** All seven of the isoforms of adenylyl cyclase identified to date are activated by  $G_{s\alpha}$  (and forskolin). Surprisingly, these features (and so-called P-site inhibition by adenosine analogs) are the only shared regulatory motifs. The type I isoform is also activated by calmodulin, while it is strongly inhibited by the G protein  $\beta\gamma$  subunit complex. Although this effect was originally attributed to sequestra-

tion of calmodulin by  $\beta\gamma$ , purification of the expressed cyclase has permitted demonstration of its direct interaction with  $\beta\gamma$  (132). The three isoforms of  $G_{i\alpha}$  and  $G_{o\alpha}$  can also inhibit type I adenylyl cyclase, but the effect is much less prominent than that of  $\beta\gamma$  when calmodulin is the activator of the enzyme and it nearly disappears when the cyclase is activated by  $G_{s\alpha}$  [105].

Type I adenylyl cyclase is the only isoform found to date that is inhibited by  $\beta\gamma$ . When we looked for such interactions with other isoforms, we were very surprised to find strong stimulation of enzymatic activity with the type II and type IV proteins (131, 150). Particularly interesting, these stimulatory effects of  $\beta\gamma$  are highly conditional. The subunits have little or no effect on adenylyl cyclase activity when added alone, but the complex stimulates enzymatic activity 5- to 10-fold when  $G_{s\alpha}$  is also present. Stimulation of type II and IV adenylyl cyclases by  $\beta\gamma$  requires substantially higher concentrations of  $\beta\gamma$  than of  $G_{s\alpha}$  and we presume that effective concentrations of both activators cannot arise by dissociation of oligomeric  $G_{\alpha}$ . The source of  $\beta\gamma$  is believed to be the  $G_i$  or  $G_o$  oligomers, both of which are present in high concentrations in brain. We thus envision type II and IV adenylyl cyclases as molecules designed to detect coincidental activation of two regulatory pathways – marking such events with a distinctive signal. The biochemical properties of these adenylyl cyclases provide an excellent explanation for phenomena described in the 1970's by Rall and associates [151] who observed highly synergistic stimulation of cyclic AMP accumulation in brain slices after application of pairs of neurotransmitters now known to work through  $G_s$ - and  $G_i$ -regulated pathways. Given activation of type II adenylyl cyclase by  $\beta\gamma$ , which presumably arises from  $G_i$ , it would be problematic if  $G_{i\alpha}$  were to inhibit the enzyme; gratifyingly, it does not.

The first really believable demonstrations of inhibition of adenylyl cyclases by  $G_{i\alpha}$  were observed with the type V and type VI isoforms, where the effect is prominent (75, 105). As noted above, it is dependent on myristoylation of these  $\alpha$  subunits and requires fairly high, but we believe quite reasonable, concentrations of the proteins (high nM –  $\mu$ M). Type V and VI adenylyl cyclases are thus regulated in the relatively simple way that was envisioned to be the general rule – activation by  $G_{s\alpha}$  and inhibition by  $G_{i\alpha}$  – but even these isoforms provided surprises, in that they are inhibited by low ( $\mu$ M) concentrations of  $Ca^{2+}$ .

Three distinct patterns of regulation of mammalian adenylyl cyclases are thus evident (Fig. 13). All isoforms are activated by  $G_{sa}$ , and two other sub classes of G proteins,  $G_i$  and  $G_q$  are implicated as well, either directly or indirectly. The effects of  $G_q$  family members are exerted through  $Ga^{2+}$ , either acting alone, with calmodulin, or with protein kinase C.  $G_i$ - and  $G_q$ - mediated pathways can both activate an adenylyl cyclase (type II and probably IV) in concert with  $G_{s\alpha}$  or they can both oppose such activation (types V and VI). The effects of  $G_i$  and  $G_q$  are antagonistic to each other with the type I enzyme. Even at this relatively early stage of investigation of the regulatory complexities of adenylyl cyclases, it is clear that these enzymes have evolved to



permit extensive integration and cross-talk between signaling pathways. The adenylyl cyclases are focal points for the convergence of a great deal of regulatory information.

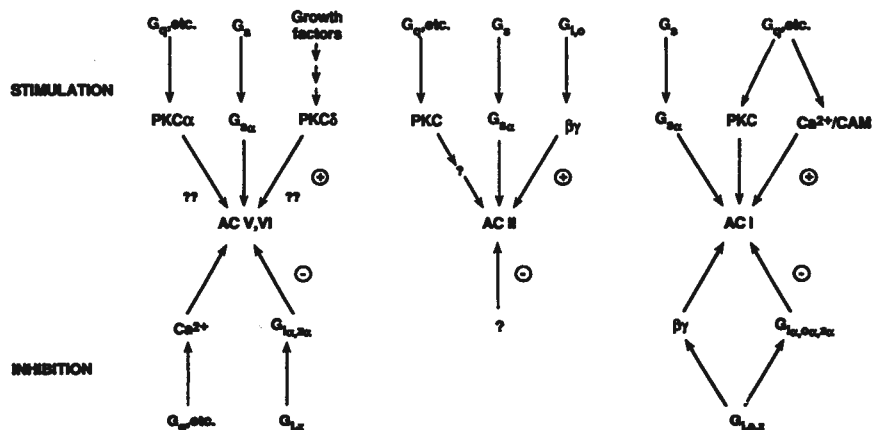

Fig. 13. Patterns of regulation of adenylyl cyclase activity. PKC = protein kinase C; CAM = calmodulin; AC = adenylyl cyclase. See text for discussion. Reprinted from Taussig and Gilman [145], with permission.

**Future Directions for Adenylyl Cyclase.** Adenylyl cyclases are labile intrinsic membrane proteins; their level of expression is low, even under artificial conditions. New tools are needed to probe their structures and mechanisms of regulation. With these thoughts in mind, Wei-Jen Tang has attempted to construct a soluble adenylyl cyclase that would retain characteristic regulatory properties, be synthesized in large quantities, and be amenable to genetic analysis. He has recently succeeded in designing and synthesizing a molecule that may have all of these properties [152]. The current product is a chimera of the  $C_{1a}$  domain of type I adenylyl cyclase, joined by a linker to the  $C_2$  domain of type II adenylyl cyclase. The molecule is synthesized by *E. coli*, where it accumulates in the cytoplasm. It is activated dramatically (from an extremely low basal activity) by  $G_{s\alpha}$  and, surprisingly, forskolin. Cyclase-deficient strains of *E. coli* are dependent on expression and activation of the adenylyl cyclase for growth on maltose. Genetic selection of mutants with informative phenotypes thus seems possible, as does purification, detailed characterization, and, hopefully, structural analysis. We hope that this approach will open the door for true understanding of these important proteins.

#### WHY G PROTEINS?

One might well ask why G proteins are included in signaling pathways and why the systems are so complex structurally. Transmembrane signaling is clearly accomplished with simpler (although usually oligomeric) molecular assemblages, such as tyrosine kinases, ligand-gated ion channels, and recep-

tor guanylyl cyclases. I believe there are several reasons for the evolution of complex signaling systems. At a relatively simple level, the existence of these molecular switches and timers permits enormous amplification in the signaling process. A single agonist-receptor complex can catalyze the activation of many G proteins during the time that a single G protein  $\alpha$  subunit remains active [153]; delayed deactivation of the  $\alpha$  subunit permits further amplification at the level of catalytic effector molecules. There is also the possibility of substantial regulatory complexity, with opportunities to modulate both the quantitative and qualitative aspects of signaling by alterations in rates of synthesis and degradation of many gene products, as well as more acute regulation by covalent modification of these molecules. Most importantly, perhaps, the tripartite nature of these signaling systems permits enormous diversity of outputs. G protein-regulated signaling pathways are characterized by both convergence and divergence at each step. Many different kinds of receptors can converge to activate a single type of G protein, while a single type of receptor can interact with more than one species of G protein to initiate several events. Similarly, different G proteins may converge on a single effector to alter its activity, either additively, synergistically, or antagonistically, while a single G protein may also interact with more than one effector. G proteins can also exert effects via either their  $\alpha$  or  $\beta\gamma$  subunits. The complexity of the cellular switchboard thus appears sufficiently vast to permit each cell to design a highly customized signaling repertoire by expression of a relatively modest number of modular components. Identification of all of these components seems certain in the next decade or so. With this information in hand, we will be able to complete our understanding of the wiring diagram of the signaling switchboard in each type of cell. Such knowledge, coupled with both increasing sophistication in rational drug design and increasingly clever approaches to screen huge chemical libraries, will revolutionize both pharmacology and therapeutics.

#### ACKNOWLEDGMENTS

There are many who have earned my most profound gratitude. My father encouraged a love of science by example, and it was carefully nurtured by my doctoral and postdoctoral mentors – Theodore W. Rall, who perhaps should have won a Nobel Prize, and Marshall W. Nirenberg, who did. All of the students and postdoctoral fellows who have worked in our laboratory have made substantial contributions. These individuals are (in alphabetical order): David Berman, Gary Bokoch, Lawrence Brunton, Patrick Casey, Françoise Coussen, Carmen Dessauer, Alex Duncan, Kenneth Ferguson, Michael Freissmuth, Boning Gao, Michael Graziano, Tatsuya Haga, Emanuel Hanski, Bruce Harris, John Hepler, Tsutomu Higashijima, Allyn Howlett, Jorge Itiiguez-Lluhi, Hiroshi Itoh, Richard Kahn, Toshiaki Katada, Christiane Kleuss, Tohru Kozasa, John Krupinski, Ethan Lee, Hsin Chieh (Calvin) Lin, Maurine Linder, Michael Maguire, David Manning, Pamela Middleton, Susanne Mumby, John Northup, Bruce Posner, Lynn Quarmby, Andre Raw,

Janet Robishaw, Elliott Ross, Leonard Schleifer, Joseph Schwarzmeier, Murray Smigel, Paul Sternweis, Roger Sunahara, Wei-Jen Tang, Ronald Taussig, and Natsuo Ueda.

Many members of our staff have also played crucial roles, but two long-term employees truly stand out. Pamela Sternweis, who joined the lab in 1973, still provides skillful assistance and an uplifting spirit to those fortunate enough to work with her. Wendy Deaner, who began to work with me in 1976 as an Administrative Assistant, now keeps much of my life and that of the Department of Pharmacology in good working order. It is notable that our relationship has also survived three editions of *Goodman and Gilman's The Pharmacological Basis of Therapeutics*.

Collaborations with others on our faculty and elsewhere have been invaluable. Particularly notable roles have been played by Susanne Mumby, Elliott Ross, Stephen Sprang, and Paul Sternweis.

Our research has been supported continuously since 1972 by grants from the National Institutes of Health (first the National Institute of Neurological Disorders and Stroke and then the National Institute of General Medical Sciences) and, since 1977, by the American Cancer Society. Other invaluable sources of support have included Mr. and Mrs. Peter O'Donnell, the Lucille P. Markey Charitable Trust, the Raymond and Ellen Willie Chair of Molecular Neuropharmacology, the Perot Family Foundation, the Meadows Foundation, and the Robert A. Welch Foundation.

#### REFERENCES

1. Rall, T. W., Sutherland, E. W., and Berthet, J. (1957) *J. Biol. Chem.* 224, 463 - 475
2. Murad, F., Chi, Y-M, Rall, T. W., and Sutherland, E. W. (1962) *J. Biol. Chem.* 237, 1233 - 1238
3. Rall, T. W. and Sutherland, E. W. (1961) *Cold Spring Harbor Symposia on Quantitative Biology* 26, 347354
4. Birnbaumer, L. and Rodbell, M. (1969) *J. Biol. Chem.* 244, 3477 - 3482
5. Limbird, L. E. and Lefkowitz, R. J. (1977) *J. Biol. Chem.* 252, 799 - 802
6. Haga, T., Haga, K., and Gilman, A. G. (1977) *J. Biol. Chem.* 252, 5776 - 5782
7. Rodbell, M., Birnbaumer, L., and Pohls, S. L. (1969) in *The Role of Adenyl Cyclase and cyclic 3',5' -AMP in Biological Systems Fogarty International Center Proceeding, No. 4, pp. 59 - 76*, National Institutes of Health, Bethesda, MD
8. Rodbell, M., Birnbaumer, L., Pohl, S. L., and Krans, H. M. J. (1971) *J. Biol. Chem.* 246, 1877 - 1882.
9. Jakobs, K. H., Aktories, R, and Schultz, G. (1979) *Arch. Pharm.* 310, 113 - 119
10. Cassel, D. and Selinger, Z. (1976) *Biochem. Biophys. Acta* 452, 538 - 551
11. Londos, C., Salomon, Y., Lin, M. C., Harwood, J. P., Schramm, M., Wolff, J., and Rodbell, M. (1974) *Proc. Natl. Acad. Sci. U.S.A.* 71, 3087 - 3090
12. Schramm, M. and Rodbell, M. (1975) *J. Biol. Chem.* 250, 2232 - 2237
13. Maguire, M. E., Van Arsdale, P. M., and Gilman, A. G. (1976) *Mol. Pharmacol.* 12, 335 - 339
14. Neer, E. J. (1974) *J. Biol. Chem.* 249, 6527 - 6531
15. Daniel, V., Litwack, G., and Tomkins, G. M. (1973) *Proc. Natl. Acad. Sci. U.S.A.* 70, 76 - 79
16. Bourne, H. R., Coffino, P., and Tomkins, G. M. (1975) *Science* 187, 750 - 752

17. Insel, P. A., Maguire, M. E., Gilman, A. G., Bourne, H. R., Coffino, P., and Melmon, K. L. (1976) *Mol. Pharmacol.* 12, 1062- 1069
18. Haga, T., Ross, E. M., Anderson, H. J., and Gilman, A. G. (1977) *Proc. Natl. Acad. Sci. U.S.A.* 74, 2016 - 2020
19. Ross, E. M. and Gilman, A. G. (1977) *Proc. Natl. Acad. Sci. U.S.A.* 74, 3715 - 3719
20. Ross, E. M. and Gilman, A. G. (1977) *J. Biol. Chem.* 252,6966 - 6969
21. Ross, E. M., Howlett, A. C., Ferguson, K M., and Gilman, A. G. (1978) *J.Biol. Chem.* 253, 6401 - 6412
22. Pfeuffer, T. (1977) *J. Biol. Chem.* 252, 7224 - 7234
23. Howlett, A. C. and Gilman, A. G. (1980) *J.Biol. Chem.* 255, 2861 - 2866
24. Northup, J. K., Sternweis, P. C., Smigel, M. D., Schleifer, L. S., Ross, E. M., and Gilman, A. G. (1980) *Proc. Natl. Acad. Sci. U.S.A.* 77, 6516 - 6520
25. Sternweis, P. C., Northup, J. K., Smigel, M. D., and Gilman, A. G. (1981) *J. Biol. Chem.* 256, 11517 - 11526
26. Northup, J. K., Smigel, M. D., and Gilman, A. G. (1982) *J. Biol.Chem.* 257, 11416 - 11423
27. Northup, J. K, Smigel, M. D., Sternweis, P. C., and Gilman, A. G. (1983)*J. Biol. Chem.* 258, 11369 - 11376
28. Howlett, A. C., Sternweis, P. C., Macik, B. A., Van Arsdale, P. M., and Gilman, A. G. (1979) *J.Biol. Chem.* 254, 2287 - 2295
29. Sternweis, P. C. and Gilman, A. G. (1982) *Proc. Natl. Acad. Sci. U.S.A.* 79,488s - 4891
30. Gill, D. M. and Meren, R. (1978) *Proc. Natl. Acad. Sci. U.S.A.* 75, 3050 - 3054
31. Moss, J. and Vaughan, M. (1977) *J. Biol.Chem.* 252,2455 - 2457
32. Kaslow, H. R., Farfel, Z., Johnson, G. L., and Bourne, H. R. (1979) *Mol. Pharmacol.* 15, 472 - 483
33. Schleifer, L. S., Kahn, R. A., Hanski, E., Northup, J. K., Sternweis, P. C., and Gilman, A. G. (1982) *J. Biol. Chem.* 257,20 - 23
34. Kahn, R. A. and Gilman, A. G. (1984) *J. Biol.Chem.* 259, 6228 - 6234
35. Kahn, R. A. and Gilman, A. G. (1986) *J.Biol. Chem.* 261, 7906 - 7911
36. Rothman, J. E. (1994) *Nature* 372, 55 - 63
37. Brown, H. A., Gutowski, S., Moomaw, C. R., Slaughter, C., and Sternweis, P. C., (1993) *Cell* 75, 1137 - 1144
38. Hazeki, O. and Ui, M. (1981) *J. Biol. Chem.* 256, 2856 - 2862
39. Katada, T. and Ui, M. (1982) *J.Biol. Chem.* 257, 7210 - 7216
40. Bokoch, G. M., Katada, T., Northup, J. K., Hewlett, E. L., and Gilman, A. G. (1983) *J. Biol. Chem.* 258, 2072 - 2075
41. Bokoch, G. M., Katada, T., Northup, J. K., Ui, M., and Gilman, A. G. (1984) *J. Biol. Chem.* 259, 3560 - 3567
42. Katada, T., Bokoch, G. M., Northup, J. K., Ui, M., and Gilman, A. G. (1984) *J. Biol. Chem.* 259, 3568 - 3577
43. Katada, T., Northup, J. K., Bokoch, G. M., Ui, M., and Gilman, A. G. (1984) *J. Biol. Chem.* 259, 3578 - 3585
44. Katada, T., Bokoch, G. M., Smigel, M. D., Ui, M., and Gilman, A. G. (1984) *J.Biol. Chem.* 259,3586 - 3595
45. Miki, N., Keims, J. J., Marcus, F. R., Freeman, J., and Bitensky, M. W. (1973) *Proc. Natl. Acad. Sci. U.S.A.* 70, 3820 - 3824
46. Wheeler, G. L. and Bitensky, M. W. (1977) *Proc. Natl. Acad. Sci. U.S.A.* 74,423s - 4242
47. Kuhn, H. (1980) *Nature* 283,587 - 589
48. Fung, B. K.-K., Hurley, J. B., and Stryer, L. (1981) *Proc. Natl. Acad. Sci. U.S.A.* 78, 152 - 156
49. Manning, D. R. and Gilman, A. G. (1983) *J. Biol. Chem.* 258, 7059- 7063
50. Hildebrandt, J. D., Codina, J., Risinger, R., and Birnbaumer, L. (1984) *J. Biol. Chem.* 259, 2039 - 2042
51. May, D. C., Ross, E. M., Gilman, A. G., and Smigel, M. D. (1985) *J. Biol. Chem.* 260, 15829-15833
52. Sternweis, P. C. and Robishaw, J. D. (1984) *J. Biol.Chem.* 259, 13806 - 13813

53. Neer, E. J., Lok, J. M., and Wolf, I. G. (1984) *J. Biol. Chem.* 259, 14222 - 14229
54. Litosch, I., Wallis, C., and Fain, J. N. (1985) *J. Biol. Chem.* 260, 5464 - 5471
55. Cockcroft, S. and Gomperts, B. D. (1985) *Nature* 314, 534 - 536
56. Hurlley, J. B., Simon, M. I., Teplow, D. B., Robishaw, J. D., and Gilman, A. G. (1984) *Science* 226, 860 - 862
57. Lochrie, M. A., Hurlley, J. B., and Simon, M. I. (1985) *Science* 228, 96 - 99
58. Yatsunami, K. and Khorana, H. G. (1985) *Proc. Natl. Acad. Sci. U.S.A.* 82, 4316 - 4320
59. Gilman, A. G. (1987) *Annu. Rev. Biochem.* 56, 615 - 649
60. Ross, E. M. (1989) *Neuron* 3, 141 - 152
61. Brown, A. M. and Birnbaumer, L. (1990) *Annu. Rev. Physiol.* 52, 197 - 213
62. Bourne, H. R., Sanders, D. A., and McCormick, F. (1990) *Nature* 348, 125 - 132
63. Bourne, H. R., Sanders, D. A., and McCormick, F. (1991) *Nature* 349, 117 - 127
64. Dohlman, H. G., Thorner, J., Caron, M. G., and Lefkowitz, R. J. (1991) *Annu. Rev. Biochem.* 60, 653 - 688
65. Kaziro, Y., Itoh, H., Kozasa, T., Nakafuku, M., and Satoh, T. (1991) *Annu. Rev. Biochem.* 60, 349 - 400
66. Simon, M. I., Strathmann, M. P., and Gautam, N. (1991) *Science* 252, 802 - 808
67. Spiegel, A. M., Backlund, P. S., Jr., Butrynski, J. E., Jones, T. L. Z., and Simonds, W. F. (1991) *Trends Biochem. Sci.* 16, 338 - 341
68. Hepler, J. R. and Gilman, A. G. (1992) *Trends Biochem. Sci.* 17, 383 - 387
69. Clapham, D. E. and Neer, E. J. (1983) *Nature* 305, 403 - 406
70. Iñiguez-Lluhi, J., Kleuss, C., and Gilman, A. G. (1993) *Trends Cell Biol.* 3, 230 - 236
71. Buss, J. E., Mumby, S. M., Casey, P. J., Gilman, A. G., and Sefton, B. M. (1987) *Proc. Natl. Acad. Sci. U.S.A.* 84, 7493 - 7497
72. Mumby, S. M., Heuckeroth, R. O., Gordon, J. I., and Gilman, A. G. (1990) *Proc. Natl. Acad. Sci. U.S.A.* 87, 728 - 732
73. Jones, T. L. Z., Simonds, W. F., Merendino, J. J., Jr., Brann, M. R., and Spiegel, A. M. (1990) *Proc. Natl. Acad. Sci. U.S.A.* 87, 568 - 572
74. Linder, M. E., Pang, I.-H., Duronio, R. J., Gordon, J. I., Sternweis, P. C., and Gilman, A. G. (1991) *J. Biol. Chem.* 266, 4654 - 4659
75. Taussig, R., Iñiguez-Lluhi, J., and Gilman, A. G. (1993) *Science* 261, 218 - 221
76. Linder, M. E., Middleton, P., Hepler, J. R., Taussig, R., Gilman, A. G., and Mumby, S. M. (1993) *Proc. Natl. Acad. Sci. U.S.A.* 90, 3675 - 3679
77. Mumby, S. M., Kleuss, C., and Gilman, A. G. (1994) *Proc. Natl. Acad. Sci. U.S.A.* 91, 2800 - 2804
78. Wedergaertner, P. B. and Bourne, H. R. (1994) *Cell* 77, 1063 - 1070
79. Fukada, Y., Takao, T., Ohguro, H., Yoshizawa, T., Akino, T., and Shimonishi, Y. (1990) *Nature* 346, 658 - 660
80. Yamane, H. K., Farnsworth, C. C., Xie, H., Howald, W., Fung, B. K.-K., Clarke, S., Gelb, M. H., and Glomset, J. A. (1990) *Proc. Natl. Acad. Sci. U.S.A.* 87, 5868 - 5872
81. Mumby, S. M., Casey, P. J., Gilman, A. G., Gutowski, S., and Sternweis, P. C. (1990) *Proc. Natl. Acad. Sci. U.S.A.* 87, 5873 - 5877
82. Iñiguez-Lluhi, J. A., Simon, M. I., Robishaw, J. D., and Gilman, A. G. (1992) *J. Biol. Chem.* 267, 23409 - 23417
83. Graziano, M. P., Freissmuth, M., and Gilman, A. G. (1989) *J. Biol. Chem.* **264, 409 - 418**
84. Van Dop, C., Tsubokawa, M., Bourne, H. R., and Ramachandran, J. (1984) *J. Biol. Chem.* 259, 696 - 698
85. West, R. E., Jr., Moss, J., Vaughan, M., Liu, T., and Liu, T.-Y. (1985) *J. Biol. Chem.* 260, 14428-14430
86. Noel, J. P., Hamm, H. E., and Sigler, P. B. (1993) *Nature* 366, 654 - 663
87. Lambright, D. G., Noel, J. P., Hamm, H. E., and Sigler, P. B. (1994) *Nature* 369, 621 - 628
88. Coleman, D. E., Berghuis, A. M., Lee, E., Linder, M. E., Gilman, A. G., and Sprang, S. R. (1994) *Science* 265, 1405 - 1412
89. Bigay, J., Deterre, P., Pfister, C., and Chabre, M. (1985) *FEBS Lett.* 191, 181 - 185

90. Higashijima, T., Graziano, M. P., Suga, H., Kainosho, M., and Gilman, A. G. (1991) *J.Biol. Chem.* 266, 3396 - 3401
91. Graziano, M. P. and Gilman, A. G. (1989) *J.Biol. Chem.* 264, 15475 - 15482
92. Landis, C. A., Masters, S. B., Spdda, A., Pace, A. M., Bourne, H. R., and Vallar, L. (1989) *Nature* 340, 692 - 696
93. Freissmuth, M. and Gilman, A. G. (1989) *J.Biol. Chem.* 264, 21907 - 21914
94. Masters, S. B., Miller, R. T., Chi, M.-H., Chang, F.-H., Beiderman, B., Lopez, N. G., and Bourne, H. R. (1989) *J.Biol. Chem.* 264, 15467 - 15474
95. Mixon, M., Coleman, D. E., Berghuis, A. M., Lee, E., Gilman, A. G., and Sprang, S. R. (1995) (Submitted)
96. Coulter, S. and Rodbell, M. (1992) *Proc. Natl Acad. Sci. U.S.A.* 89, 5842 -5846
97. Robishaw, J. D., Smigel, M. D., and Gilman, A. G. (1986) *J.Biol. Chem.* 261, 9587 - 9590
98. Bray, P., Carter, A., Simons, C., Guo, V., Puckett, C., Kamholz, J., Spiegel, A., and Nirenberg, M. (1986) *Proc.Natl Acad. Sci. U.S.A.* 83, 8893 - 8897
99. Kozasa, T., Itoh, H., Tsukamoto, T., and Kaziro, Y. (1988)*Proc.Natl. Acad. Sci. U.S.A.* 85, 2081 - 2085
100. Jones, D. T. and Reed, R. R. (1989) *Science* 244, 790 - 795
101. Yatani, A., Codina, J., Imoto, Y., Revees, J. P., Birnbaumer, L., and Brown, A. M. (1987) *Science* 238, 1288 - 1292
102. Schubert, B., VanDongen, A. M. J., Kirsch, G. E., and Brown, A. M. (1989) *Science* 245, 516 - 519
103. Lerea, C. L., Somers, D. E., Hurley, J. B., Klock, 1. B., and Bunt-Milam, A. H. (1986) *Science* 234, 77 - 80
104. McLaughlin, S. K., McKinnon, P. J., and Margolskee, R. F. (1992) *Nature* 357, 563 -569
105. Taussig, R., Tang, W.-J., Hepler, J. R., and Gilman: A. G. (1994) *J.Biol. Chem.* 269,6093 - 6100
106. Codina, J., Yatani, A., Grenet, D., Brown, A. M., and Birnbdumer, L. (1987) *Science* 236,442 - 444
107. Logothetis, D. E., Kurachi, Y.,Galper, J., Neer, E. J., and Clapham, D. E. (1987) *Nature* 325, 321 - 326
108. Stow, J. L., de Almeida,J. B., Narula, N., Holtzman, E. J., Ercolani, L., and Ausiello, D. A. (1991) *J. Cell Biol.* 114, 1113 - 1124
109. Donaldson, J. G., Kahn, R. A., Lippincott-Schwartz, J., and Klausner, R. D. (1991) *Science* 254, 1197 - 1199
110. Ktistakis, N. T., Linder, M. E., and Roth, M. G. (1992) *Nature*356, 344 - 346
111. Wong, Y. H., Conklin, B. R., and Bourne, H. R. (1992) *Science* 255, 339- 341
112. Kozasa, T. and Gilman, A. G. (1994) *J.Biol. Chem.* (in press)
113. Casey, P. J., Fong, H. K. W., Simon, M. I., and Gilman, A. G. (1990)*J.Biol. Chem.* 265, 2383 - 3490
114. Hescheler, J., Rosenthal, W., Trautwein, W., and Schultz, G. (1987) *Nature* 325, 445 - 447
115. Strittmatter, S. M., Valenzuela, D., Kennedy, T. E., Neer, E. J., and Fishman, M. C. (1990) *Nature* 344, 836 - 841
116. Strittmatter, S. M., Valenzuela, D., Sudo, Y., Linder, M. E., and Fishman, M. C. (1991) *J.Biol. Chem.* 266, 22465 - 22471
117. Strathmann, M., Wilkie, T. M., and Simon, M. I. (1989) *Proc. Natl. Acad. Sci. U.S.A.* 86, 7407 - 7409
118. Taylor, S. J., Smith, J. A., and Exton, J. H. (1990) *J. Biol. Chem.* 265, 17150- 17156
119. Waldo, G. L., Boyer, J. L., Morris, A. J., and Harden, T. K. (1991) *J. Biol. Chem.* 266, 14217-14225
120. Smrcka, A. V., Hepler, J. R., Brown, K. O., and Sternweis, P. C. (1991) *Science* 251,804 - 807
121. Bernstein, G., Blank, J. L., Jh on, D. Y., Exton, J. H., Rhee, S. G., and Ross, E. M. (1992) *Cell* 70, 411 - 418

122. Parks, S. and Wieschaus, E. (1991) *cell* 64, 447 - 458
123. Chan, A. M. L., Fleming, T.P., MCGovern, E. S., Chedid, M., Miki, T., and Aaronson, S. A. (1993) *Mol. Cell. Biol.* 13, 762 - 768
124. Xu, N. Z., Bradley, L., Ambdukhar, I., and Gutkind, J. S. (1993) *Proc. Natl. Acad. Sci. U.S.A.* 90, 6741 - 6745
125. Higashijima, T., Ferguson, K. M., Sternweis, P. C., Smigel, M. D., and Gilman, A. G. (1987) *J. Biol. Chem.* 262, 762 - 766
126. Cerione, R. A., Staniszewski, C., Caron, M. G., Lefkowitz, R. J., Codina, J., and Birnbaumer, L. (1985) *Nature* 318, 293 - 295
127. Gilman, A. G. (1984) *Cell* 36, 577 - 579
128. Florio, V. A. and Sternweis, P. C. (1985) *J Biol. Chem.* 260, 3477 - 3483
129. Dietzel, C. and Kurjan, J. (1987) *Cell* 50, 1001 - 1010
130. Tang, W.-J., Krupinski, J., and Gilman, A. G. (1991) *J. Biol. Chem.* 266, 8595 - 8603
131. Tang, W.-J. and Gilman, A. G. (1991) *Science* 254, 1500 - 1503
132. Taussig, R., Quarumby, L. M., and Gilman, A. G. (1993) *J. Biol. Chem.* 268, 9 - 12
133. Camps, M., Hou, C., Sidiropoulos, D., Stock, J. B., Jakobs, K. H., and Gierschik, P. (1992) *Eur. J. Biochem.* 206, 821 - 831
134. Camps, M., Carozzi, A., Schnabel, P., Scheer, A., Parker, P. J., and Gierschik, P. (1992) *Nature* 360, 684 - 686
135. Ueda, N., Iñiguez-Lluhi, J. A., Lee, E., Smrcka, A. V., Robishaw, J. D., and Gilman, A. G. (1994) *J. Biol. Chem.* 269, 4388 - 4395
136. Kissilev, O. and Gautam, N. (1993) *J. Biol. Chem.* 268, 24519 - 24522
137. Kleuss, C., Hescheler, J., Ewel, C., Rosenthal, W., Schultz, G., and Wittig, B. (1991) *Nature* 353, 43 - 48
138. Kleuss, C., Scherubl, H., Hescheler, J., Schultz, G., and Wittig, B. (1992) *Nature* 358, 424 - 426
139. Kleuss, C., Scherubl, H., Hescheler, J., Schultz, G., and Wittig, B. (1993) *Science* 259, 832 - 834
140. Pfeuffer, T. and Metzger, H. (1982) *FEBS Lett.* 146, 369 - 375
141. Smigel, M. D. (1986) *J. Biol. Chem.* 261, 1976 - 1982
142. Krupinski, J., Coussen, F., Bakalyar, H. A., Tang, W.-J., Feinstein, P. G., Orth, K., Slaughter, C., Reed, R. R., and Gilman, A. G. (1989) *Science* 244, 1558 - 1564
143. Tang, W.-J. and Gilman, A. G. (1992) *Cell* 70, 869 - 872
144. Iyengar, R. (1993) *FASEB J* 7, 768 - 775
145. Taussig, R. and Gilman, A. G. (1995) *J. Biol. Chem.* 270, 1 - 4
146. Kataoka, T., Broek, D., and Wigler, M. (1985) *Cell* 43, 493 - 505
147. Toda, T., Uno, I., Ishikawa, T., Powers, S., Kataoka, T., Brock, D., Cameron, S., Broach, J., Matsumoto, K., and Wigler, M. (1985) *Cell* 40, 27 - 36
148. Nakdne, M., Arai, K., Saheki, S., Kuno, T., Buechler, W., and Murad, F. (1990) *J. Biol. Chem.* 265, 16841 - 16845
149. Chinkers, M. and Wilson, E. M. (1992) *J. Biol. Chem.* 267, 18589 - 18597
150. Gao, B. and Gihndn, A. G. (1991) *Proc. Natl. Acad. Sci. U.S.A.* 88, 10178 - 10182
151. Sattin, A., Rall, T. W., and Zanella, J. (1975) *J. Pharmacol. Exp. Ther.* 192, 22 - 32
152. Tang, W.-J. and Gilman, A. G. (1995) *Science* 268, 1769 - 1772
153. Brandt, D. R. and Ross, E. M. (1986) *J. Biol. Chem.* 261, 1656 - 1664
154. Linder, M. E. and Gilman, A. G. (1992) *Sci. Am.* 267(1), 56 - 65