

WILLIAM F. GIAUQUE

Some consequences of low temperature research in chemical thermodynamics

Nobel Lecture, December 12, 1949

The basic purpose which underlies most of the work in the Low Temperature Laboratory, of the University of California, is the study of entropy.

It is easy for a chemist to write an equation for a desired reaction, but this does not mean that the reaction will actually take place. If one knows the heats of formation and entropies of the substances concerned in the equation, the so-called free energy or thermodynamic potential of the reaction may be calculated. A knowledge of the free energy change permits chemists to determine all reactions which are thermodynamically possible and the extent to which they are possible. When it has been found that a certain reaction should go, but experiment fails, then a catalyst can be sought or the conditions can be altered so as to secure a practicable rate of reaction. If the free energy shows that the reaction is thermodynamically impossible, a search for a catalyst is futile.

The third law of thermodynamics, which developed from the Nernst Heat Theorem, states that all perfect crystalline substances approach zero entropy as the absolute zero of temperature is approached. According to this statement a knowledge of the heat capacity, to sufficiently low temperatures, will permit the calculation of the absolute entropy of a substance. It was this possibility which interested me in low temperature research.

Fig. 1 shows a few typical low-temperature heat-capacity curves for condensed gases. They have been measured by my students, Drs. R. Wiebe, H. L. Johnston, J. O. Clayton and R. W. Blue, and myself. The curve on the right of each graph represents the heat capacity of the liquid. The other curves represent the heat capacities of the one or more crystalline forms of the several substances.

Fig. 2 is a plot of the heat capacity of solid carbon dioxide against the logarithm of the temperature. According to the third law of thermodynamics the area under the curve, multiplied by 2.3026 to convert the ordinary to natural logarithms, is the absolute entropy of solid carbon dioxide.

Fig. 3 shows a drawing of the first low-temperature heat-capacity apparatus used in our work. It consisted of a calorimeter, C, surrounded by a protective hollow block of copper, B, both suspended in a high vacuum in container A.

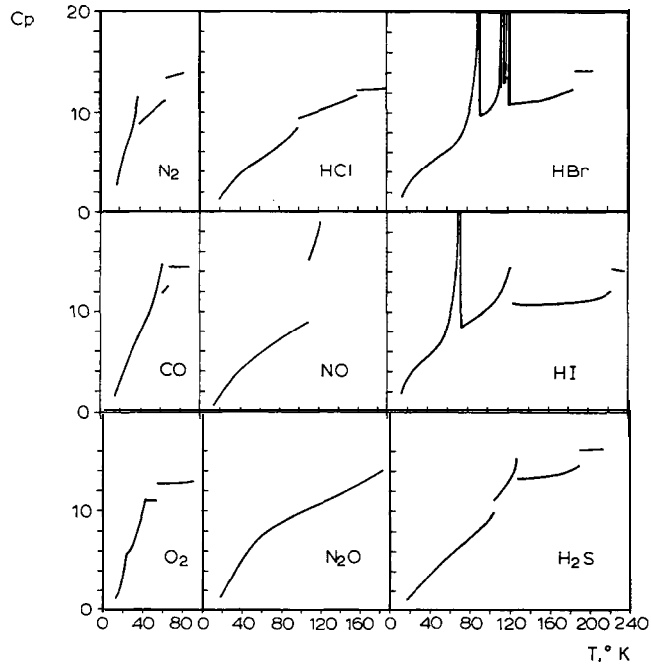

Fig. 1. Heat capacity in calories per degree per mole.

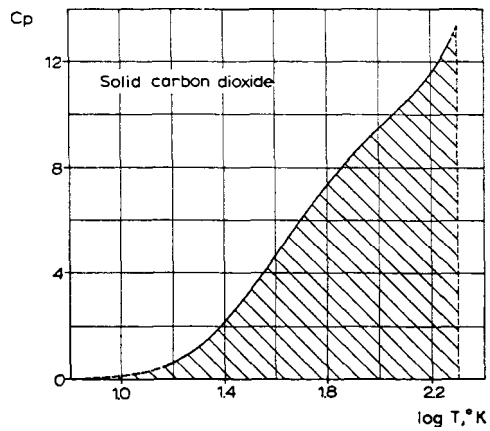

Fig. 2. Heat capacity in calories per degree per mole.

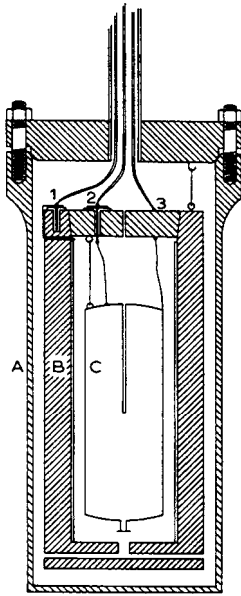

Fig. 3. Low temperature calorimeter.

The calorimeter was equipped with a resistance thermometer-heater, somewhat after the arrangement introduced by Professor A. Eucken. The block could be heated to, and held at, any obtainable temperature. In addition to resistance thermometers, copper-constantan thermocouples were attached to both calorimeter and block.

Fig. 4 shows a more recent calorimeter. It is of the type used for numerous low temperature investigations on condensed gases. The particular one shown was designed for the work with Dr. C. J. Egan on carbon dioxide which is illustrated in Fig. 2. The protective hollow block contains considerable lead in the upper portion to maintain an appreciable heat capacity at the lower temperatures. The apparatus can be cooled, first with liquid nitrogen, and then with liquid and solid hydrogen, until it reaches a temperature near 10° absolute. Helium gas is used in the space surrounding the calorimeter to provide heat conductivity during the cooling. When the cooling is completed the helium is removed by means of a high-vacuum pump and measurements are started. Some idea as to the sensitivity of the resistance thermometers used in this work may be obtained from the fact, that there are approximately 10,000 millimeter marks for each degree centigrade, on the scale which is read. If desired, this may be increased to the order of 30,000

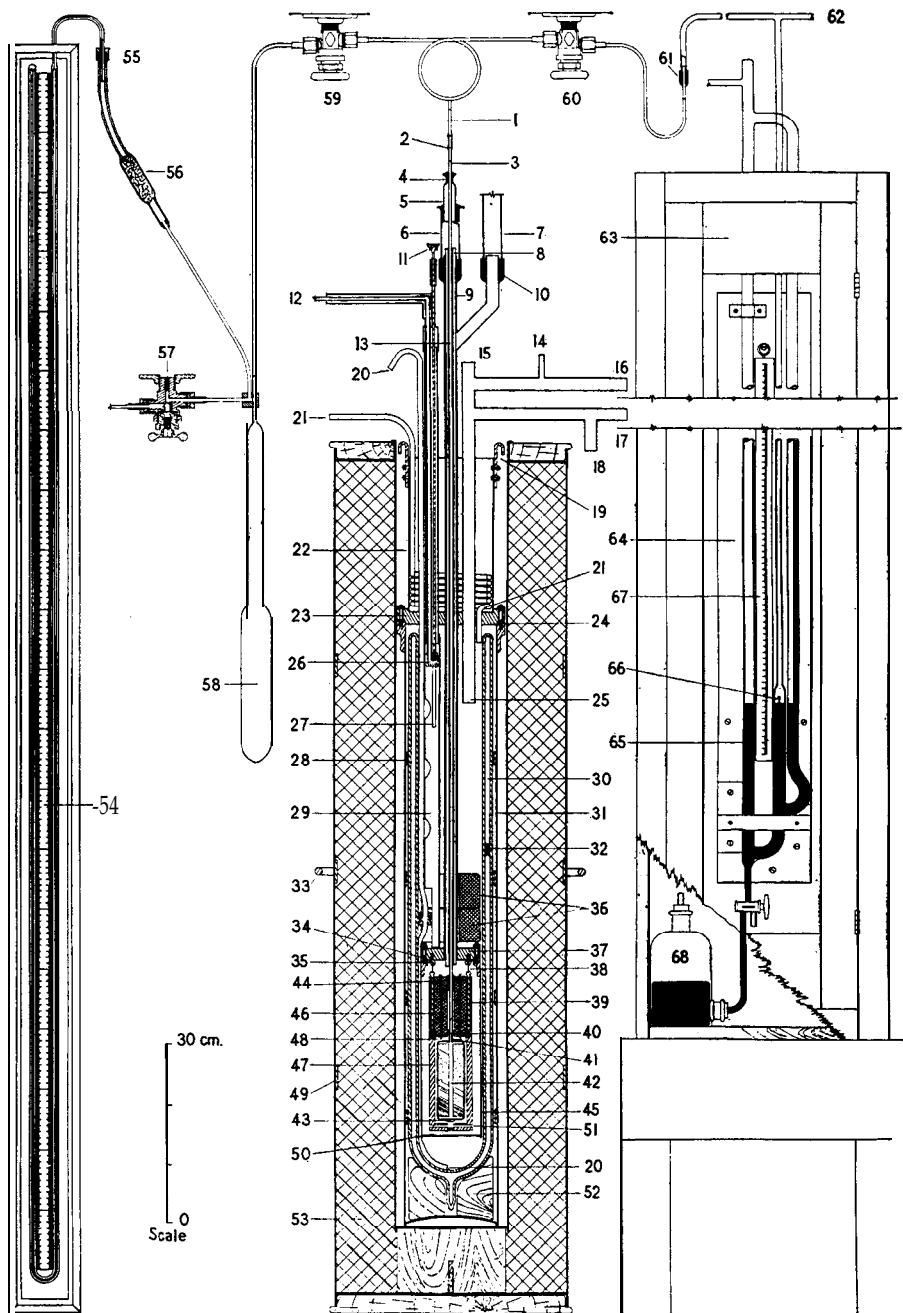

Fig. 4. Low temperature calorimeter for condensed gases.

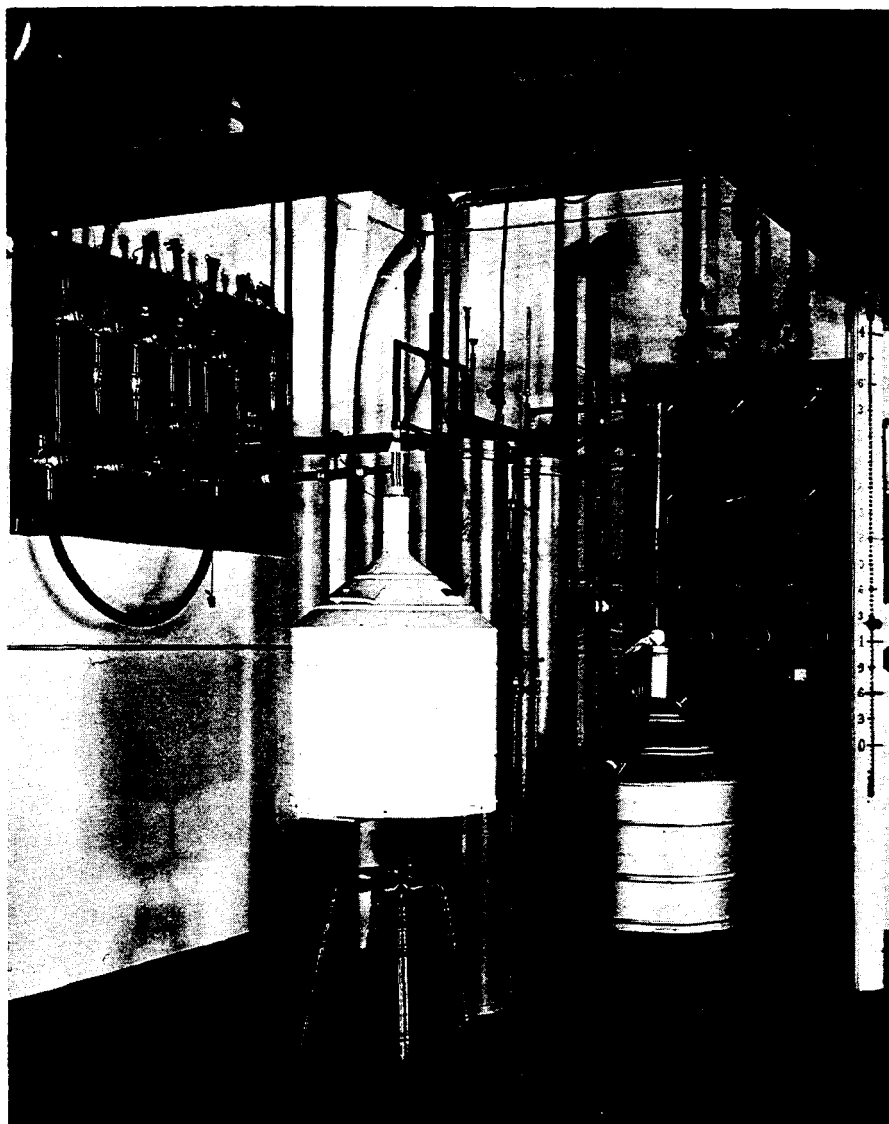

Fig. 5. Hydrogen liquefier.

millimeters per degree, for much of the range below 100° K. This high precision is desirable for observing heat leak and the attainment of thermal equilibrium within the calorimeter.

Figs. 5 and 6 show typical views in the low temperature laboratory. Fig. 5 is a photograph of the hydrogen liquefier located under a ventilating hood.

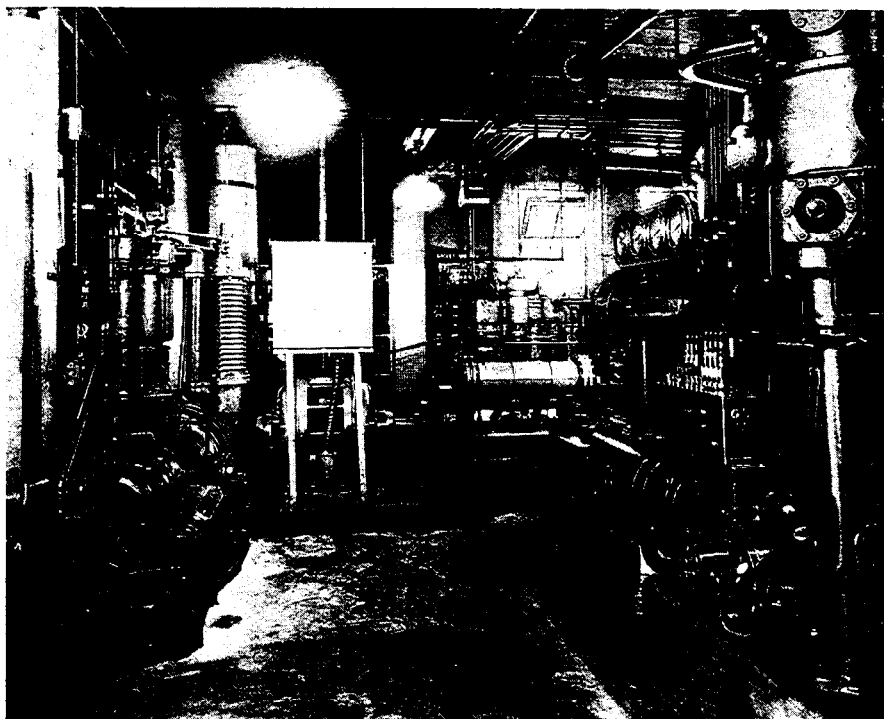

Fig. 6. View in machinery room. Ethane compressor (*left*), hydrogen compressor (*center*), air compressor (*right*).

A container of liquid nitrogen, for cooling the high-pressure hydrogen gas, stands at the right of the liquefier, and a similar 50 liter container is attached to a vacuum-jacketed transfer tube, to receive the liquid hydrogen.

Fig. 6 shows a portion of the machinery room with the compressors used in connection with the liquefaction of ethane, hydrogen, and air.

Practically all of the equipment in the laboratory has been specially designed for its purpose and, aside from compressors and standard instruments, it has been largely constructed in the laboratory shops. Fig. 7 is a photograph of a heat interchanger with a special type of construction that we have developed for this work. The one shown is used to liquefy air. Purified air at 270 atmospheres pressure is sent through the interchanger tubes, and after being pre-cooled with liquid ethane, some 30 percent of the air is obtained as liquid by means of simple Joule-Thompson expansion. A little over one liter of liquid is produced for each kilowatt hour of energy. The liquid can be withdrawn as liquid air, but is normally separated into pure nitrogen (0.03%

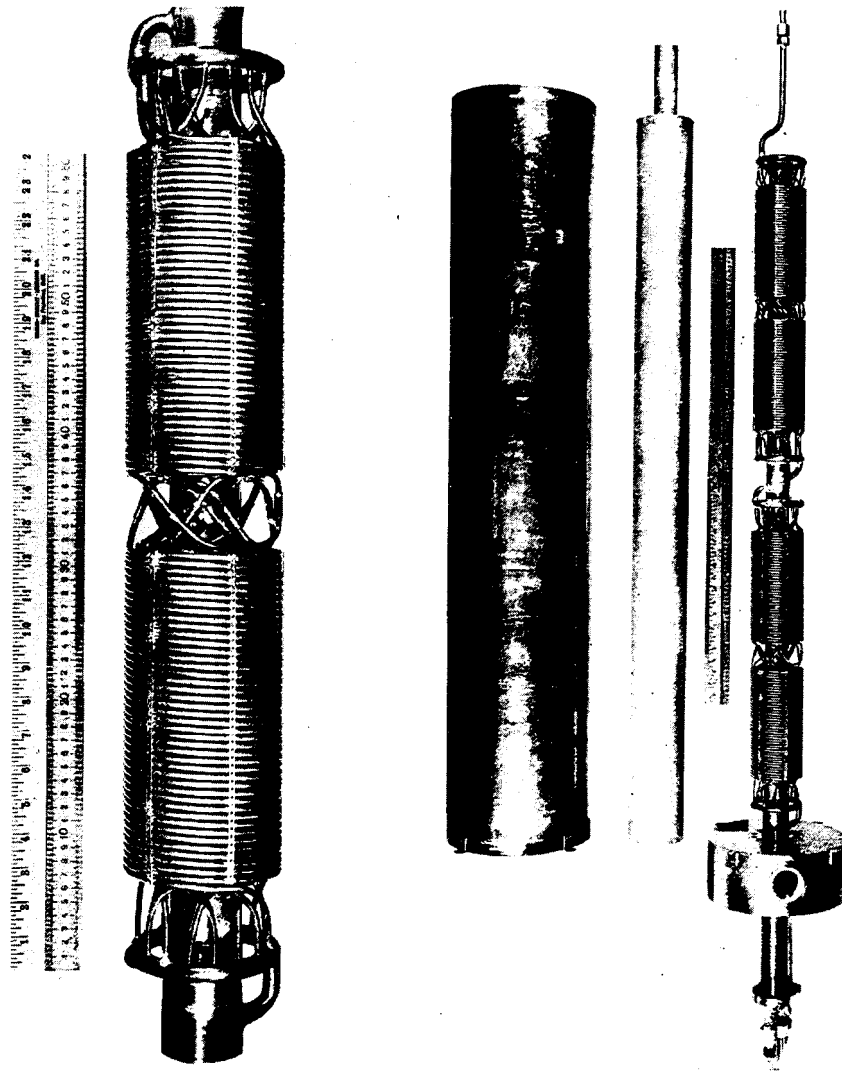

Fig. 7. High-pressure heat interchanger.

oxygen) and oxygen (99.8 to 99.5% depending on the amount produced) before their simultaneous withdrawal as liquids.

The interchanger shown in Fig. 7, was designed to produce 70 liters of liquid per hour. An enlarged view of a portion of it is shown at the left. The complete interchanger with its jacket and insulating case is shown at the right.

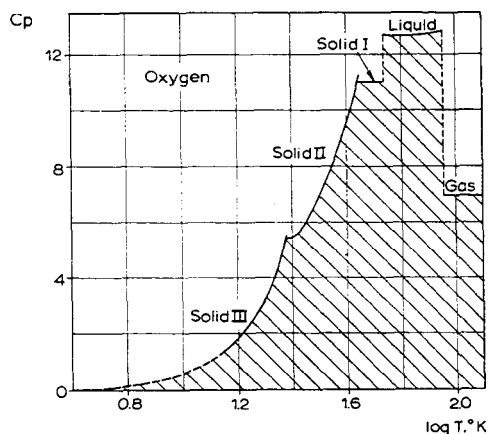

Fig. 8. Heat capacity in calories per degree per mole.

The equipment which has been described has been used to determine the entropies of many chemical substances.

The careful determination of entropy has often been accompanied by the discovery of unexpected physical properties. The discovery of the oxygen isotopes of atomic weights 17 and 18 was a case of this kind. The sequence of events was as follows:

An accurate measurement of the low-temperature heat capacity of oxygen was undertaken with Dr. H.L. Johnston. The data are represented in Fig. 8, where the heat capacity has been plotted against the logarithm of the absolute temperature. The area under the curves was used to calculate the entropy of oxygen gas. In this case, as had long been known, there are three crystalline forms and the liquid before the gas state is reached and thus it was also necessary to measure the increase in entropy during each change of state.

One of the principal lines of research which we have pursued in connection with the determination of entropy is the calculation of this, and other thermodynamic quantities, by means of quantum statistics and the energy levels of gas molecules. These energy levels can be obtained from band spectra.

Fig. 9 is a photograph of the band spectrum of oxygen taken by Mr. Harold D. Babcock of Mount Wilson Observatory. The strong doublets are due to ordinary oxygen (16-16) and their interpretation is due to Professor R. S. Mulliken of the University of Chicago.

This spectrum permits the determination of the energy levels of the oxygen molecule. When the entropy of oxygen gas was calculated from these strong

lines it agreed exactly with the value obtained from our low temperature measurements.

The spectrum also contains many weak lines, which were believed to be due to oxygen, but which were not understood. These weak lines were discovered by Babcock and most of them were measured and published by Dieke and Babcock. Later Babcock published some additional observations.

It is rather interesting that these weak lines are themselves an unexpected by-product of a solar investigation by Babcock. When sunlight passes through the molecules in the earth's atmosphere some of the light is absorbed selectively by them. This effect may be enhanced by photographing the sun when it is low on the horizon because the light then passes through a greater amount of air.

An entropy calculation based on band spectra is not considered to be satisfactory unless the spectrum is completely explained. One way to explain weak lines is to assume, that they are due to some higher energy state of the molecule, and are weak because not many molecules are in the higher energy state. Many of the weak lines in the oxygen spectrum are actually due to this effect but they could not all be explained in this way.

Months of thinking about this problem led to memorization of the essentials of the data and I literally awoke one morning with the realization that the lines must originate from an isotopic species. Detailed calculations by Dr. Johnston and myself confirmed this accurately and it was determined that isotopes of atomic weights 17 and 18 exist in the earth's atmosphere.

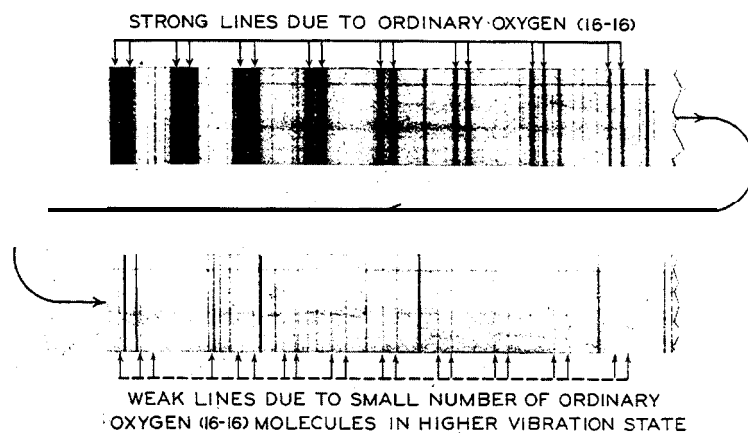

Fig. 9. Small section of band spectrum due to sunlight absorbed in Earth's atmosphere.

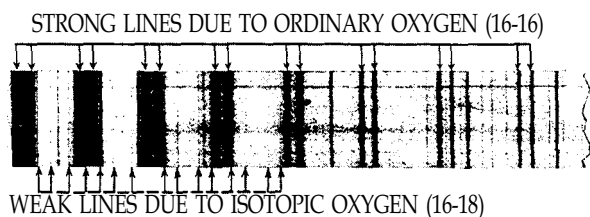

Fig. 10. Small section of atmospheric oxygen bands showing lines due to oxygen 16-18. (Photograph by *Harold D. Babcock, Mount Wilson Observatory.*)

In Fig. 10 the photograph of the oxygen band spectrum is shown with arrows pointing to the weak lines due to the 16-18 oxygen molecules. A similar set of very faint lines, which are not visible in Fig. 10 are due to molecules of oxygen 16-17.

When suitable isotopic masses are assumed, all of the weak lines due to isotopes can be calculated accurately from the positions of the strong lines.

The discovery that oxygen isotopes existed made it evident that physicists and chemists were unknowingly using different scales of atomic weights. Chemists take the atomic weight of the isotopic mixture as 16. Physicists use a mass spectrograph and take the predominant isotope as 16. This isotope is somewhat less than 16 on the chemists' scale.

Similarly, the adiabatic demagnetization method of producing low temperatures, was an unexpected by-product of our interest in the third law of thermodynamics.

As we have seen, the heat capacities of substances ordinarily become very small at temperatures below 10 or 15° absolute. Thus it had been considered that essentially all of the entropy had been removed from substances at these low temperatures and, aside from a minor extrapolated amount, it was customary to assume this in calculating entropy.

During a seminar in the fall of 1924 I presented calculations showing the way in which magnetic fields affect the thermodynamic properties of various substances. Some magnetic susceptibility measurements on gadolinium sulfate octahydrate, at the temperature of liquid helium, came to my attention. These measurements had been published by Professors Woltjer and Kamerlingh Onnes, from the University of Leiden.

The measurements of Woltjer and Kamerlingh Onnes are shown in Fig. 11. By means of appropriate thermodynamic equations it was possible to calculate the change of entropy when a magnetic field is applied. I was greatly

surprised to find, that the application of a magnetic field removes a large amount of entropy from this substance, at a temperature so low that it had been thought that there was practically no entropy left to remove.

The above conclusion was based only on the application of thermodynamics to the experimental data; however, further investigation led to a quantum statistical explanation of the magnetic data. The curve in Fig. 11 is not drawn through the points but is the result of a calculation entirely independent of the measurements.

Fig. 12 illustrates what happens when a magnetic field is applied to a paramagnetic substance like gadolinium sulfate. The arrows on the diagram correspond to atomic magnets. Their normal state is one of disorder which corresponds to the presence of entropy. When a sufficiently powerful magnetic field is applied the magnets line up and the entropy is removed. The removal of entropy is accompanied by the evolution of heat. Those familiar with thermodynamics will realize that in principle any process involving an entropy change may be used to produce either cooling or heating. Accordingly it occurred to me that adiabatic demagnetization could be made the basis of a method for producing temperatures lower than those obtainable with liquid helium. Professor P. Debye also arrived at similar conclusions.

In order to understand refrigeration by means of magnetic properties we will look at the analogous case of refrigeration by means of a gas expansion engine in an idealized form.

The first step is shown in Fig. 13. It illustrates the first part of the compression of a gas in a cylinder from which heat can escape. The entropy of the gas is decreased.

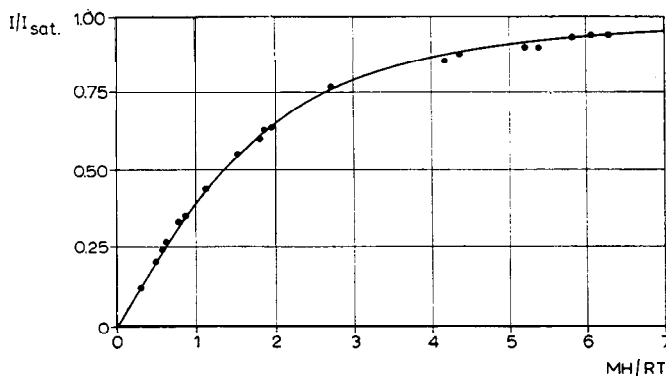

Fig. 11. Intensity of magnetization of $Gd_2(SO_4)_3 \cdot 8H_2O$. Data of Woltjer and Kamerlingh Onnes compared with the theoretical curve.

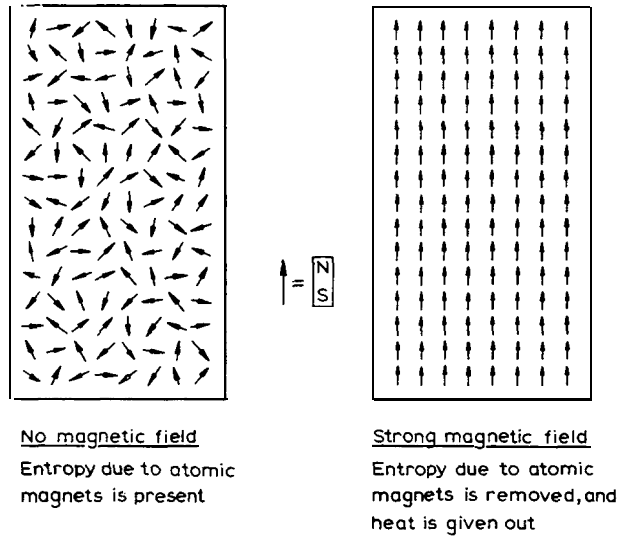

Fig. 12. Atomic magnets in crystal lattice.

The second step is shown in Fig. 14. The compression has been ended and heat has been given out so that the compressed gas has the same temperature as it had before compression. Some heat insulation is now placed symbolically so that no heat can pass between the gas and its surroundings.

The third and final step is shown in Fig. 15. The gas is permitted to expand and does work against the piston. The energy equivalent of this work comes from the thermal energy of the gas molecules and thus the gas cools. This process is called adiabatic expansion.

The steps leading to adiabatic demagnetization are very similar. Figure 16 is a schematic drawing showing a paramagnetic substance located within the coil of a solenoid magnet. The magnetic material is enclosed in a jacket, which is filled with helium gas to conduct heat. The apparatus inside the coil is immersed in liquid helium. When the current is started through the coils

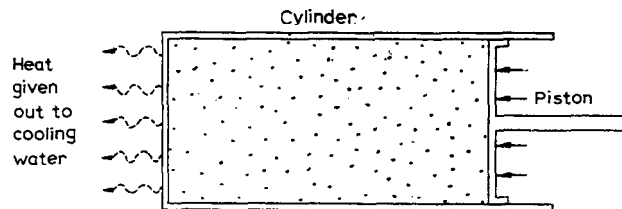

Fig. 13. Refrigeration by means of an expansion engine (idealized). *First step:* Gas is compressed. Heat is given out.

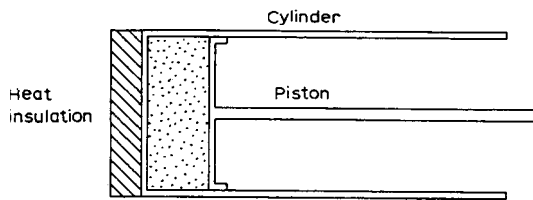

Fig. 14. Refrigeration by means of an expansion engine (idealized). *Second step* : Compression complete. Heat has been removed until final temperature equals initial temperature. Cylinder is then insulated against flow of heat.

of the magnet the atomic magnets begin to line up, heat is given out, and the entropy is decreased. The magnet coil in Fig. 16 appears to be in the liquid helium region; however, it is not placed there in actual experiments for practical reasons.

The second step is shown in Fig. 17, which illustrates the limiting case of complete magnetization. Heat has escaped until the final temperature is the same as the initial temperature. In actual experiments the magnetization is often very far from complete due to the limitations of equipment.

The substance is now insulated against heat flow by evacuating the helium gas from the insulating jacket.

The third, and final, step is shown in Fig. 18. As the magnetic field is decreased the magnetic material does work by contributing to the current in the surrounding circuits. This work is analogous to that done on the piston of the expansion engine but in this case it is done through the agency of electromagnetic fields acting through space. The work is done at the expense of the thermal energy of the substance which is thus cooled to a very low temperature.

The fact that energy can be removed from a paramagnetic substance, through a highly evacuated space, by means of electromagnetic work, is of

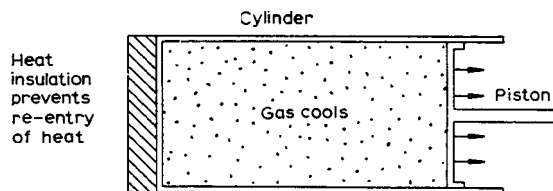

Fig. 15. Refrigeration by means of an expansion engine (idealized). *Third step* : Gas expands. No heat can enter. Mechanical work is done on the piston at the expense of the molecular energy. Loss of energy cools gas to lower temperature. This is adiabatic expansion.

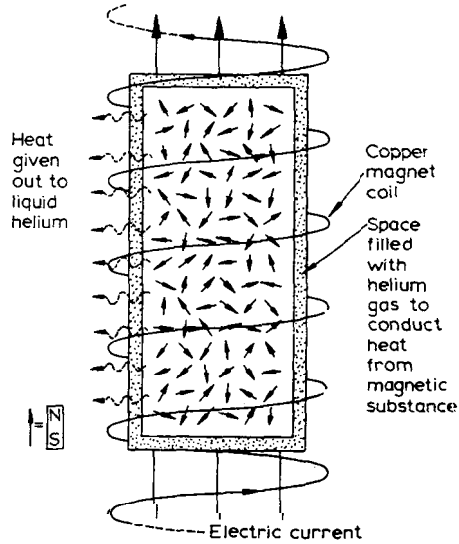

Fig. 16. Refrigeration by means of adiabatic demagnetization. *First step*: Electric current is started through magnet. Heat is given out as paramagnetic substance is magnetized.

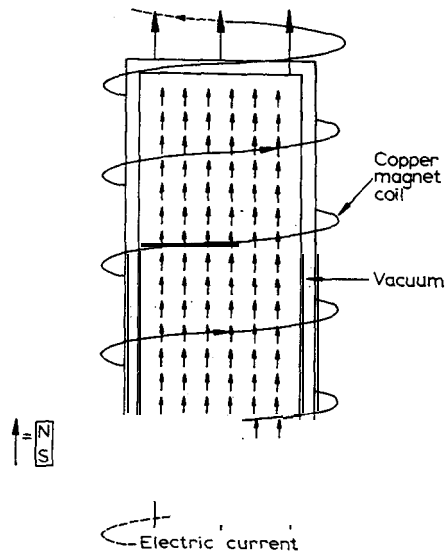

Fig. 17. Refrigeration by means of adiabatic demagnetization. *Second step*: Full electric current through magnet. Magnetization is complete. The substance is now insulated against flow of heat by pumping a vacuum in the jacket.

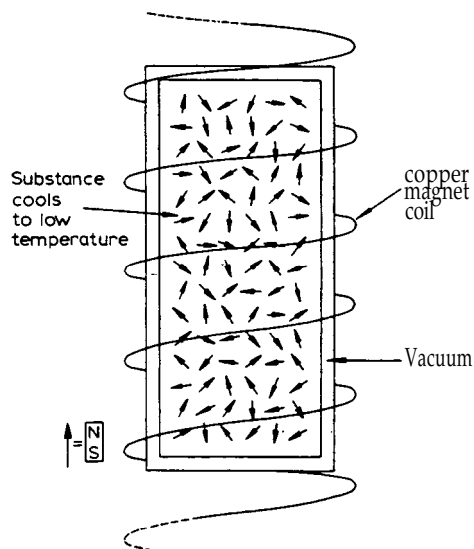

Fig. 18. Refrigeration by means of adiabatic demagnetization. *Third step:* Electric current turned off. Substance is demagnetized. No heat can enter. Substance does magnetic work through space by inducing an electric current in copper coils of magnet. The work is done at the expense of the molecular energy. Loss of energy cools substance. This is adiabatic demagnetization.

great practical importance to the method. It is this fact that makes possible the almost complete thermal isolation of the working substance while the low temperature is being produced.

Fig. 19 shows a drawing of an early apparatus. The central tube is filled with a paramagnetic substance. When the magnetic field is applied, the heat evolved boils away some of the liquid helium. The jacket, which can be evacuated after the heat is removed, surrounds the magnetic material. The low temperature is produced as soon as the magnet current can be turned off. A coil of tubing is shown around the outside of the Dewar vessel. Liquid nitrogen is passed through this coil to protect the liquid helium from radiation heat leak.

Fig. 20 shows a drawing of the solenoid magnet which has been used in this work. Sections have been shown as though they were cut away to disclose the conductors and the interior. The adiabatic demagnetization apparatus is mounted in the center. Cooling oil is pumped rapidly over the bare copper conductors to remove heat. Efficient heat transfer is the principal problem in the design of such magnets.

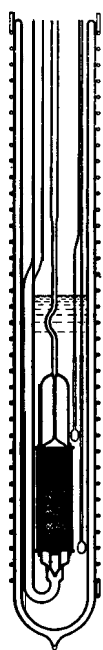

Fig. 19. Paramagnetic substance in vacuum jacket immersed in Dewar vessel of liquid helium.

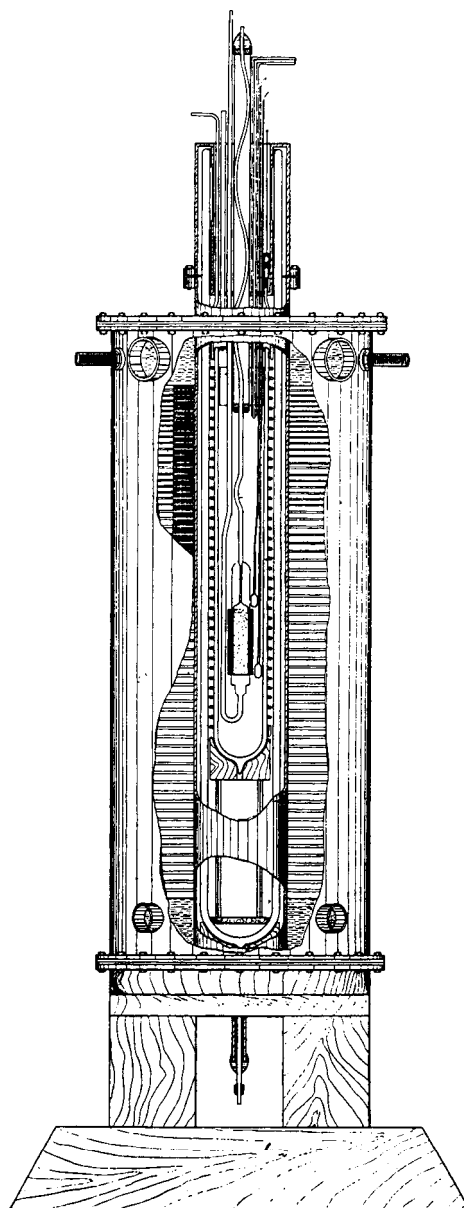

Fig. 20. Solenoid magnet with adiabatic demagnetization apparatus.

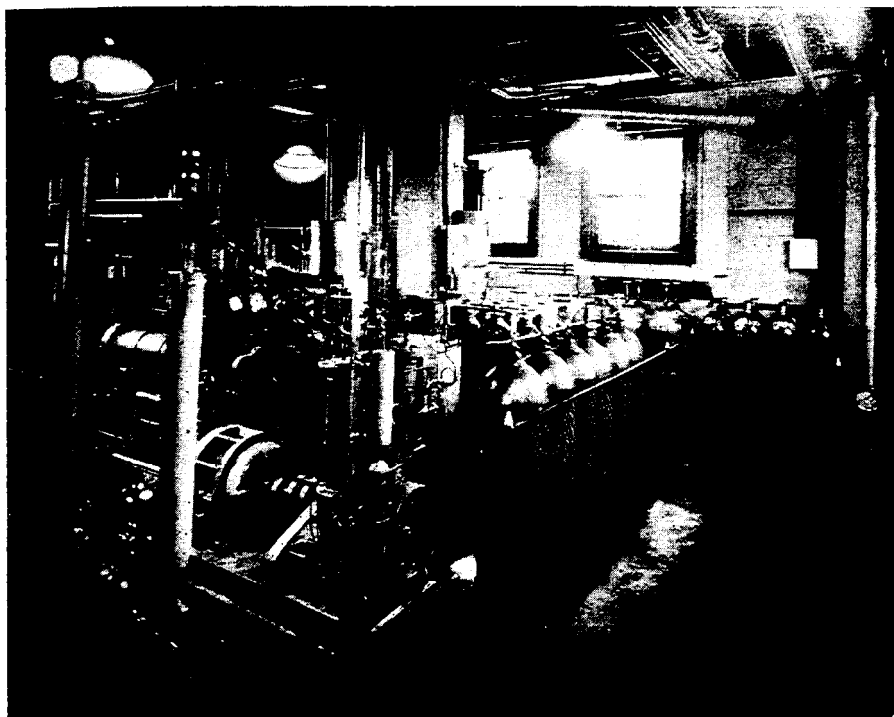

Fig. 21. View in machinery room. Helium compressor and gas storage cylinders in foreground.

Some additional photographs of the low temperature laboratory are shown as Figs. 21, 22 and 23. Figure 21 shows the helium compressor and some of the gas storage cylinders. Figure 22 shows the helium liquefier to the right of the solenoid magnet. Liquid helium is transferred through a vacuum jacketed transfer tube into the Dewar vessel in the interior of the magnet. In our present arrangement the liquid helium can be made about one meter deep. Additional liquid is added only once a day when experiments of long duration are in progress.

Fig. 23 is a photograph of the apparatus about as it was assembled and used by Dr. D. P. MacDougall and myself in the first adiabatic demagnetization experiment in 1933. The inductance bridge used to measure the magnetic susceptibility of the gadolinium sulfate octahydrate used is shown on the table in the foreground.

MacDougall sat at the table to make the first observation, I pulled the

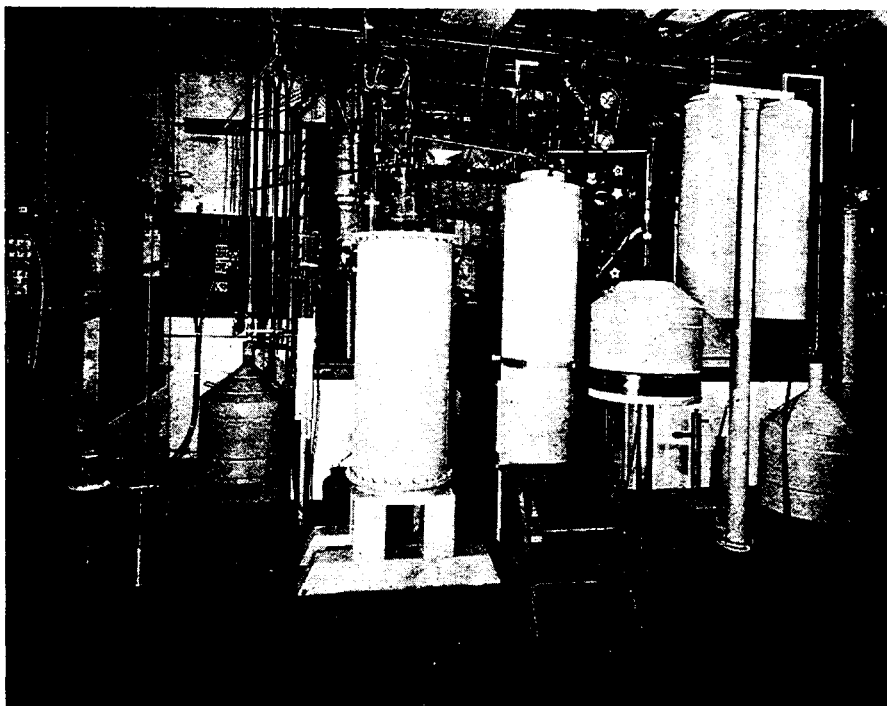

Fig. 22. Helium liquefier (*behind steps*), helium purifier (*at right*), solenoid magnet (*at left*).

switches in the left background and watched the expression on MacDougall's face. In a short time he announced that the cooling had occurred.

The commonest question asked in the early days of this work was : "How do you know it gets cold?" This was a fair question. Obviously no one had ever made thermometers which were calibrated at temperatures that had never been produced. Since even helium gas has negligible pressure, at the low temperatures obtained, a gas thermometer is useless.

Temperature can only be measured by some property of a substance which varies with temperature. In this case the magnetic susceptibility increases as temperature decreases.

Fig. 24 illustrates the measuring coil system of an early apparatus. The coil is in several sections, two of which are around the equatorial region of the simple cylindrical sample to minimize correction for end effects. The coil system is outside the vacuum jacket and is immersed in liquid helium during use. The coils contained many thousands of turns of fine copper wire. When

an alternating electric current is passed through a measuring coil it becomes increasingly difficult for the current to pass as the magnetic susceptibility of the substance increases. This effect permits the quantitative determination of magnetic susceptibility.

Fig. 25 shows how the magnetic susceptibility varies with temperature according to Curie's law. However, one of the consequences of the third law of thermodynamics is that Curie's law must fail as the absolute zero is approached. Curie's law has proved very useful but temperatures obtained in this way are at best approximate.

Lord Kelvin defined thermodynamic temperature in such a way that any method utilizing an entropy change to attain a lower temperature, contains within itself, a method of determining that temperature. One must, of course, be able to make the necessary measurements in a thermodynamically reversible manner. Fortunately this is a straight forward procedure in the case of many paramagnetic substances although it requires a large number of correlated experimental measurements.



Fig. 23. Inductance bridge (*on table*). Solenoid magnet and helium liquefier (*centre rear*).

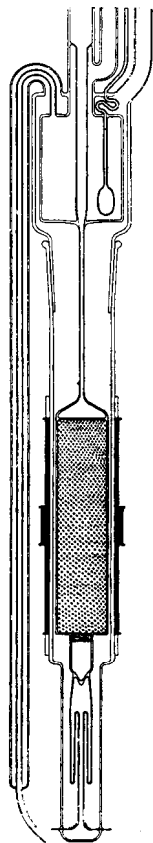

Fig.24. Measuring coil system around paramagnetic sample.

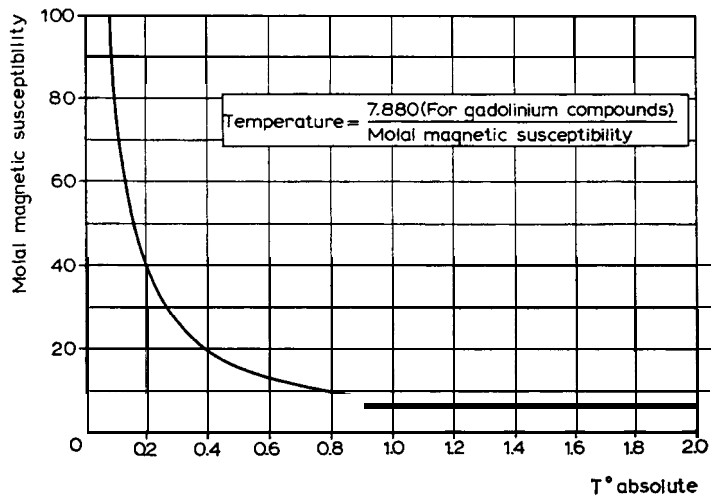

Fig. 25. Absolute temperature according to Curie's law.

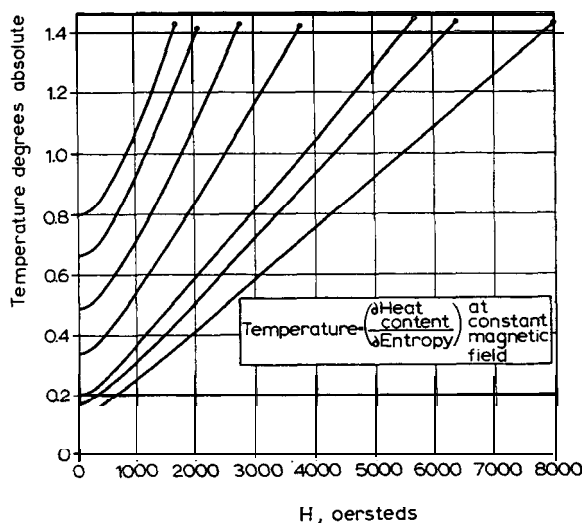

Fig. 26. Change of thermodynamic temperature with magnetic field at constant entropy for gadolinium phosphomolybdate tridecahydrate.

Fig. 26 shows the way in which the true absolute temperature changes during the course of adiabatic demagnetization of the chemical compound, gadolinium phosphomolybdate tridecahydrate. These temperatures were calculated from the thermodynamic relationship that the absolute temperature is equal to the rate of change of heat content with entropy at constant magnetic field.

It may be seen that there is a definite lower limit of temperature which is extended downward by increasing the initial magnetic field. The field available in our present magnet is only 8,000 oersteds, however it is expected that much more powerful magnets will be available in the not too distant future.

As is well known a temperature of 0.004° K has been produced in this way with a field of 24,000 oersteds by Professors de Haas and Wiersma, at the University of Leiden.

Fig. 27 shows the characteristics of the most sensitive type of thermometer we have devised for use in the region below 1° absolute. It was made of lampblack, supported on optical polishing paper, cemented together and held on to glass, by means of a very thin film of collodion. The data shown were obtained during work with Drs. J. W. Stout and C. W. Clark.

Resistance thermometers of this type are also useful as electric heaters for introducing measured quantities of heat under some circumstances. Long

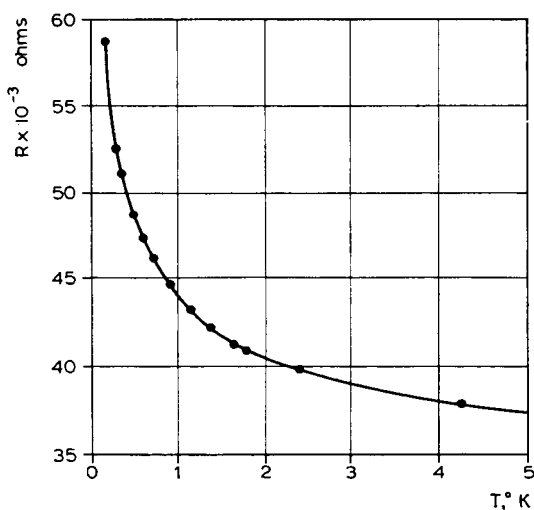

Fig. 27. The resistance of a carbon thermometer as a function of temperature.

glass leads with narrow platinized strips to carry the current are shown near the bottom of Fig. 24.

An example of the measurement of heat capacity in this way, to temperatures below $1^\circ K$, is shown in Fig. 28, for cobalt sulfate heptahydrate. The apparatus utilized by Dr. J. J. Fritz to measure the heat capacity and magnetic properties of $\text{CoSO}_4 \cdot 7\text{H}_2\text{O}$ is shown in Fig. 29. The ellipsoidal

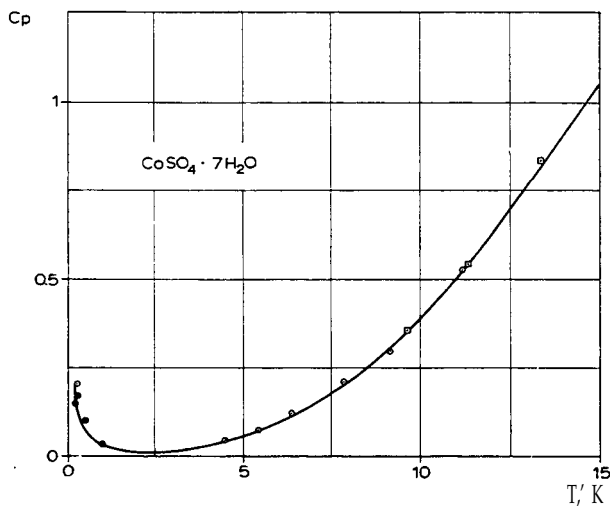

Fig. 28. Heat capacity in calories per degree per mole.

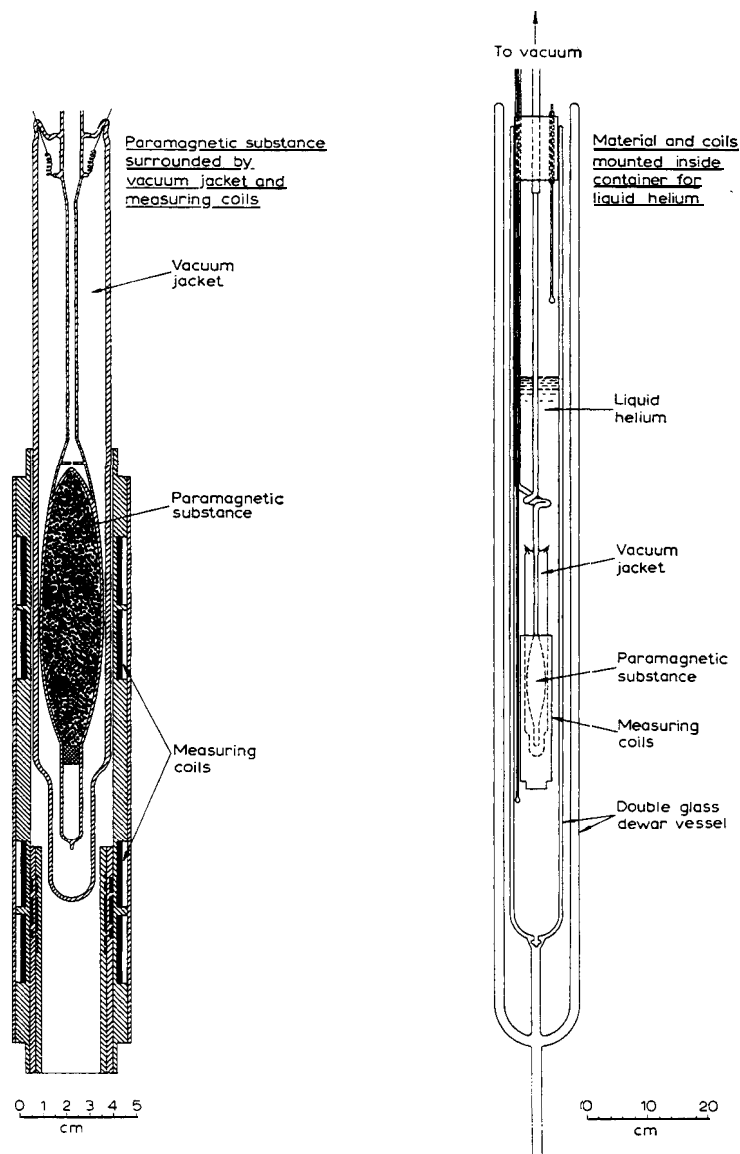

Fig. 29. Adiabatic demagnetization apparatus.

shape simplifies magnetic behavior and makes accurate calculation of end effects possible. Magnetic hysteresis can be investigated with any of the calorimeters which have been shown, by means of the heating effect in an alternating field. With 60 cycle current the hysteresis in gadolinium compounds is undetectable, except at the very low temperatures, and even there

it is so small, that the processes of magnetization and demagnetization rank with the most perfectly reversible of known processes. However, this is not true in all substances and all sorts of effects ranging to remanent magnetism exist.

If a substance becomes a permanent magnet at very low temperatures, it is easy to measure the strength of the magnet. This may be done by slowly warming the magnetic material. The apparatus shown then acts as an electric generator with no moving parts except the atoms. As the paramagnetic substance is warmed, any change in the magnetic moment will generate a potential in the coil, which can be quantitatively measured by a sensitive galvanometer and used to determine the total magnetic induction.

The resistance of the wire in measuring coils drops to such low values at the temperatures of liquid helium that very large numbers of turns can be used. The sensitivity which is obtained with coils at these low temperatures is such that it is necessary to compensate for the small fluctuations in the Earth's magnetic field.

These are some examples of the type of things that are to be found by those who inquire into the subject of entropy. We consider it a rich field for further investigation.