

SLOW NEUTRON SPECTROSCOPY AND THE GRAND ATLAS OF THE PHYSICAL WORLD

Nobel Lecture, December 8, 1994

by

Bertram N. Brockhouse

Department of Physics, McMaster University, Hamilton, ONT, L8S 4M1, Canada

On October 12, 1994, telephone communications from Stockholm ensured that I would have the privilege of giving a Nobel Lecture, for which I must thank all those involved in arranging for this great and surprising event of my life. But I had to go back some thirty to forty-five years, first in memory and then in the entropy of my files and library. The lecture was given on December 8, 1994 (and subsequently on several occasions). This written version covers the same ground, though sometimes in different order, with a little additional material from my preparations, which time prevented including in the spoken lecture.

In August 1950, when I joined the Physics Division of the Chalk River Nuclear Laboratory, it was 18 years since the identification of the neutron as being emitted in some radioactive processes and 14 years since verification of the supposition that neutrons would exhibit wave-particle duality. A considerable body of theory was available in the open literature - which was still small enough so that one person could have read all that was then available. There had been significant measurements of total cross sections using neutron beams produced by cyclotrons. Self-sustaining reactors employing the neutron-induced fission of uranium had been demonstrated and full-scale models which emitted potent beams of both fast and slow neutrons had been constructed. Slow neutron beams from reactors were already in use at several laboratories (including Chalk River) for studies of crystals and other forms of matter. The works of E.O. Wollan and C.G. Shull at the Oak Ridge National Laboratory were particularly significant because they included the first studies of a number of phenomena and because they already presented values of scattering power for neutrons of a substantial number of elements. This history is discussed in the lecture of my senior colleague and co-winner of the 1994 Nobel Prize in Physics, Clifford Shull.

To 1951, some studies had been made of the elastic scattering of monochromatic slow neutrons by specimens in the form of powdered crystals (the neutron analog of Debye-Scherrer patterns for X-rays), which led to improved crystallographic understanding of the substances involved. And there

were a few studies of the angular distribution of slow neutrons scattered by certain specimens in the liquid or gaseous form. Most importantly, magnetic scattering of neutrons, by crystalline substances which contained atoms with magnetic moments, had been demonstrated and some simple magnetic structures determined. But the thermal diffuse scattering, expected from theory, had been studied only as the total cross section for incident neutrons of long wavelength (beyond the possibility of Bragg scattering). No spectroscopic measurements had been made, though there existed relevant theory and the phenomenon of neutron slowing-down (moderation) gives assurance that energy changes on single-scattering must occur.

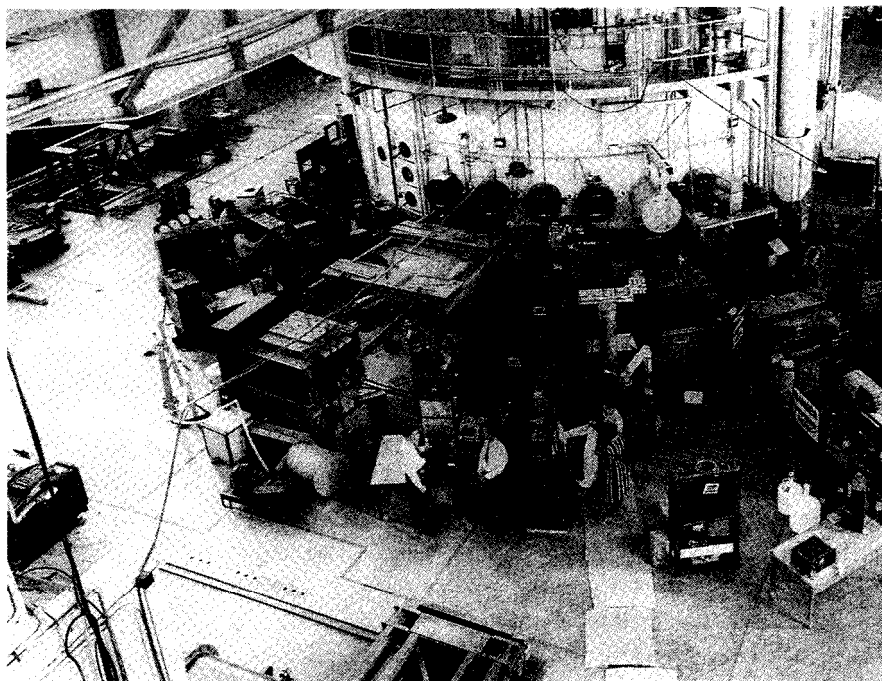

Fig. 1: The main floor of the NRX Reactor at the Chalk River Laboratory about 1950. The powder diffractometer constructed by Donald Hurst and associates is visible near the centre of the photograph. Most of the other equipment is concerned with nuclear physics or with the physics of the neutron itself. For reasons of space, each apparatus is located at the end of a long tube. (AECI. photo)

Fig. 1 shows the main floor of the hall at Chalk River with the NRX reactor ("pile"), a very powerful one for the times. A variety of experiments were underway, mostly in nuclear physics but the double-axis powder diffractometer, constructed by Dr. Donald Hurst and associates, is visible near the centre of the photograph. The large size of the equipment is enjoined by the necessity of shielding against the fast neutrons which accompany the slow neutron beams - one's own beam and one's neighbours - for low experimental background as well as for biological protection.

It is necessary to remember that many things which a researcher of the present would take for granted were then not available - not available on the

market or not available at all. Counting electronics were still under development in-house, recording apparatus was mostly analog and of limited availability as to kind. The first digital computer at Chalk River was delivered in 1954 and occupied a large room with heat-generating electronics (no siliconics!). The single crystals available were mostly of natural origin, though large ingots of NaCl and other alkali halides were produced for use in infrared spectrometry and were available commercially. But opposed to all this sort of thing, was the remarkable openness of the possibilities available. If an experiment could be envisaged, it was likely new or at least repeating it would not be merely trivial.

A. The NEUTRON and its APPLICATIONS

In 1982 a Conference was held at Cambridge in honour of the 50th Anniversary of the discovery by James Chadwick of the free neutron. The Proceedings [A] deal with the numerous consequences of this event and their histories. Beyond those military consequences so important in the media and beyond the applications to the public energy supply (Nuclear Energy), to Nuclear Medicine and to Nuclear Physics and Chemistry, there have come into existence a number of new scientific fields.

These fields involve neutrons produced by nuclear reactions (as "fast" neutrons) with energies usually millions of electron volts (MeV) and then allowed to "slow down" by repeated collisions with atomic nuclei of small atomic weight ("moderation") to a near-equilibrium distribution at a temperature at little above that of the moderator, often water at a temperature somewhat above room temperature. A small tube through the reactor shielding admits a beam of the fast, intermediate and slow neutrons into the experimental hall.

After dealing with the undesired fast neutrons, well-defined beams of the "slow neutrons" are then employed in a variety of ways to study the properties of material specimens placed in the neutron beam (or in subsidiary neutron beams derived from the first). The fields of interest here are known generically by the terms (slow) neutron scattering or neutron diffraction. The scattering may be elastic or inelastic; in the latter case the experiments may involve measurements of the energy changes experienced by the neutrons when scattered by the specimen, in which case the term (slow) neutron spectrometry is often used. When the incident neutrons have energies well below what they would have if in equilibrium at room temperature (0.025 eV) they are often termed "cold neutrons".

Slow neutrons have energies from millivolts (meV) to tenths of an eV and by the same token have wavelengths from 10 Angstroms or more to tenths of an Angstrom. This fact, that neutrons have, simultaneously, energies of the order of the characteristic quantum energies in condensed matter and wavelengths of the same order as inter-atomic dimensions, is of the first importance to the new subjects. There are several other favourable circumstances:

the velocity of the neutrons (hundreds of metres/sec) is suitable for mechanical measurement. For many materials neutrons penetrate deeply before being captured or scattered; this allows many things to be done which are not possible with other radiations.

The Bibliography gives ample access to the various branches of the subject: neutron optics, neutron diffraction and neutron spectrometry, all possibly involving nuclear and/or magnetic scatterers. Reference [B] "Fifty Years of Neutron Diffraction", has many articles from several points of view, by 35 authors (including Dr. Shull and myself) as well as reprints of the 1936 papers of the very first workers in the field. A much larger bibliography compiled up to 1974, by Larose and Vanderwal [Q], shows the remarkable growth in the number of publications in the subject per year, from the 50 or so in the 1950s to about 800 by 1971 and no doubt many more in recent years.

Thus the fields have grown to the extent that one person, or even a committee, can no longer be fully consonant of what has been done, of what is in the literature. For the larger literature of Science in general or Physics in general this is true *a fortiori*, no one - no one at all - can be sure of the non-existence of some particular results, relevant to his projects. In general this is insurmountable but Physics moves step-by-step with Technology into the future; it is the availability or non-availability of technologies in the open market which defines the "present" or "state of the art" of research. Neutron Spectrometry could not flourish until large neutron sources were for some reason available. The researches of Dr. Shull and his colleagues, like those of myself and mine, were by-products of programs set in motion for other reasons.

The GRAND ATLAS

This brings us to the Grand Atlas, viz, the scientific literature of the state-of-the-art present. There can be histories of the Grand Atlas, but only historical artifacts and theories of history are contained within it. The Grand Atlas includes the "petit atlas" - earthly geography and geology in their most reliable current scientific guises - and the scientific, currently accepted, "recipes" of physics and chemistry. Thus the Grand Atlas comprises "maps" of the world we live in, metaphorical maps which just might prove to be metaphysical, maps that link percepts (which can be thought of as metaphorical geography) with other percepts, by means of theory (which involves concepts and which can be thought of as metaphorical geology). The percepts are sense-data: meter-readings, features in a photograph and the like. The concepts are names involved in the apposite theories. But it does not do to forget that percepts are themselves theory-based, that beyond the photograph is the theory of photography - and of the photographer.

The observations (like the theories) are made by reputed scientists; the observers (like the theoreticians) have done their work openly and reported

it in ways that permit repetition. The maps of the Grand Atlas can be checked by other scientists, they are scientific - purportedly backed by men who have a right to an opinion on the matter. Whether the maps are to be called "scientific facts" is to be known only after-the-fact, a posteriori, by users of the maps. Similarly, whether a particular map is to be thought of as pertaining to metaphysical reality (or even to actuality now) is a religious and philosophical matter.

For strictly scientific or technological purposes all this is irrelevant. On a pragmatic view, as on a religious view, theory and concepts are held in faith. On the pragmatic view the only thing that matters is that the theory is efficacious, that it "works" and that the necessary preliminaries and side issues do not cost too much in time and effort. Beyond that, theory and concepts go to constitute a language in which the scientific matters at issue can be formulated and discussed.

Of course we would like much more than that. We would like to know whether it is possible to say of "Alberta 100 million B.C.": "Here be dinosaurs." or, at least, "Here were dinosaurs.", to say of an aluminium crystal: "Here be Al atoms.", to say of the theoretical nuclei of conceptual Al atoms: "Here be protons and neutrons.", to say of the mathematical Al crystal lattice: "Here be phonons." We would like to be certain of what the Grand Atlas ultimately means. And of course, once obtained, we might not like that knowledge at all. As it is, each of us takes his own scientific view of these matters, a more or less conscious aspect of his religious views on "the nature of things".

At a given epoch of the "state-of-the-art" there are applications visible - technological or scientific applications - and also perhaps moral implications which go to forbid or enjoin them. And there can be metaphors visible, which modelled upon, may ultimately find places as theory held in faith, in the Grand Atlas. So that metaphors too are to be watched for their moral implications; nuclear fission, nuclear fusion are examples. Might it not be better that these notions never have been thought?

Thus concepts which are not immediately testable by experience - which are not themselves scientific - remain always questionable. At any given epoch Physics are true by definition; if not true now, the Physics in question never were true. The same is true generally of "the scientific". In the world to which the Grand Atlas applies, there is an enduring tension: additional evidence increases the reasonableness of accepting the concepts as actual entities or even as moral, not merely mental, realities - but the burden of proof can always be shifted to the opposite side. Observation or experimentation can suggest an addition or modification to a theory or can support an existing implementation of the theory. Experiment can refute or falsify such an implementation, but a new implementation may be found which agrees sufficiently with experiment to be acceptable. At a deep enough level in the intellectual structure, a theory is very difficult to refute.

SLOW NEUTRON SPECTROMETRY

Theories of the physics of condensed matter involve the most basic aspects of modern physics: the principles of conservation (energy, linear momentum etc.), the chemical elements in various ionic forms, electrons, neutrons, quantum mechanics. Implementations for a particular substance in a particular setting, usually involve drastic approximations if the required quantum statistical calculations are to be possible. Happily, because the nuclear and magnetic interactions between the neutron and atom are (in some sense) weak, the very good "first Born approximation" is applicable, and the neutrons are effectively "decoupled" from the dynamics of the scattering system which can be considered in isolation. The neutron, in being scattered, "causes" transitions between the quantum states of the scattering system but does not change the states.

In general the scattering system is modelled, with assistance of experimental information about it. For example, the chemical constitution would be taken as given. An aluminium crystal would be taken to have the face-centred cubic (FCC) structure indicated from X-ray or neutron diffraction; theoretical calculation would be unlikely to produce this *ab initio*. The dynamics of the so-defined system could be studied *a priori* by simple models, or could be studied using a phenomenological theory with numerous parameters to be fitted. The Born-von Kármán theory [O] of crystal lattice vibrations can host either approach, at least to some degree. From the model, macroscopic properties (optical, thermodynamic and the like) can be calculated and compared with experiment. Until the advent of neutron spectroscopy, only qualitative comparison was normally possible - the "distance" between the concepts at the atomic level and the percepts at the macroscopic level was simply too great.

Normally neutron energies (with their associated momenta) are inferred from their wavelengths as determined by diffraction from a single crystal through the Bragg Law, or from their times of flight over a known distance. In each case the energy is proportional to the inverse square of the measured quantity. Thus, at the theoretical level, spectrometers based on the two methods have the same law of dispersion. (Any measurement of the same spectrum by the two methods is implicitly a test of quantum mechanics.) However, crystal spectrometers have additional dispersion from the Bragg transformation from angle of reflection to wavelength. The two methods are very different in their technical aspects and the associated experimental problems.

The first method considered at Chalk River (in 1951) and (I think) elsewhere, was to employ time-of-flight to measure both incoming and outgoing neutrons. The "Double-Chopper" method was to employ electrically phased choppers to select the energy of the incoming neutrons and the time-of-flight from the second chopper to the detector to infer the energy of the scattered neutrons. (Bernard Jacrot, at Saclay, built and employed for a time [26] a double-chopper consisting of two large wheels on a rotating shaft.) It was soon apparent that development of a competent Double-Chopper instru-

ment would be technologically demanding. So at Chalk River attention shifted to the use of crystal diffraction for both energy measurements - the "Triple-Axis" neutron crystal spectrometer which will be discussed here later. The Double-Chopper later received extensive development elsewhere, particularly at the hands of Peter Egelstaff at Harwell. Mixed systems were also developed, of which the "Rotating Crystal" spectrometer [43] is probably the best known. This system employs a spinning crystal as initial monochromator and measures the spectrum by time of flight.

There is also an historically important method - the "Filter-Chopper" or "Cold Neutron" method [29 - 32]. The concept originated at Brookhaven, I think. A modified version was developed at Chalk River, largely by my colleague Alec T. Stewart. The method employs a polycrystalline filter of certain materials (notably beryllium metal) with particularly low neutron absorption and "parasitic" scattering, to eliminate all slow neutrons except those of such long wavelength (so slow) that they cannot be Bragg-scattered out of the beam by the filter. The scattered neutrons are then analyzed by a Chopper-based time-of-flight apparatus. In the Chalk River version two filters were employed (Be and Pb), in differential fashion.

An inverse of this method, the "Filter-Detector" or "Beryllium Detector" method [43] employs crystal diffraction for the monochromator and detects just "cold" neutrons. It has uses in studying those modes of motion in condensed matter of particularly high energy.

Absorption Methods

A number of elements exhibit large capture cross sections for slow neutrons. Boron and lithium and others have capture cross sections proportional to the wavelength; cadmium (and some rare earths) have neutron resonances with cross sections steeply varying with energy. When such absorbers intercept the neutrons scattered by a specimen, the measured intensity of the scattered neutrons depends on the neutron spectrum. In fact, the relative transmission of the scattered neutrons, for a sequence of absorbers running the gamut from very thin to very thick, is in essence related to the spectrum by a Laplace transform. The first experiments in neutron spectrometry, done in 1951 - 2 at A.E.R.E. Harwell by P.A. Egelstaff [21] and R.D. Lowde [23] and at Chalk River by Brockhouse and Hurst [22], employed such methods, but in very different ways. Only the last noted will here be discussed.

Over the range 0.2 eV to 0.5 eV the total cross section of Cd drops from over 6000 barns to less than 150. For an incident energy of 0.35 eV the transmission of Cd absorbers is quite sensitive to the scattered neutron spectrum. Fig. 2 shows transmission curves of annular Cd absorbers, for neutrons of initial energy 0.35 eV, scattered through a mean angle of 90 degrees, into an annular detector, by satisfactorily "thin" scatterers of lead, aluminium, graphite and diamond powder. The expected results for elastically scattered neutrons (with corrections for geometric effects) are also shown. (Some small

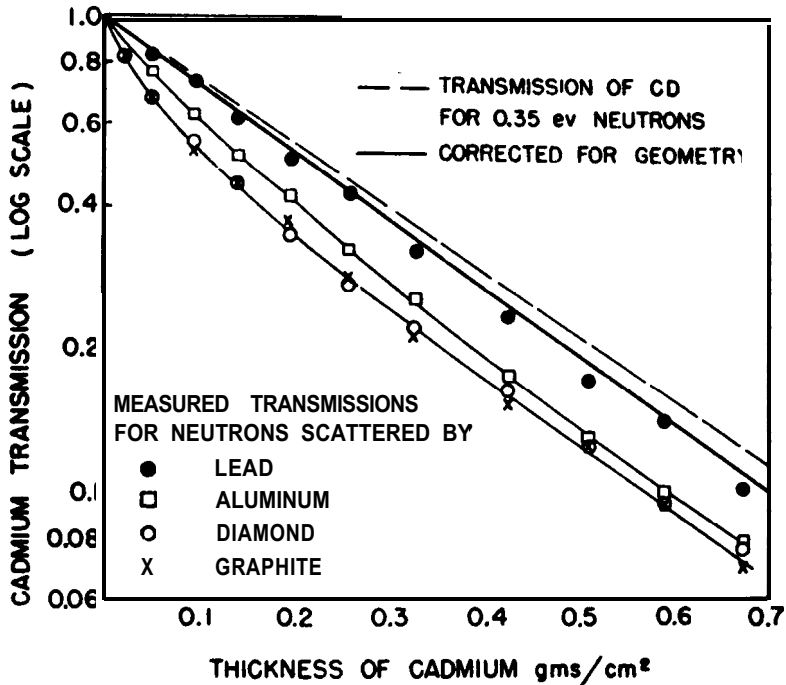

Fig. 2: The relative transmission of neutrons scattered into an annular detector by thin specimens of four materials, for annular Cd absorbers of various thickness, as well as the estimated transmission of elastically scattered neutrons. Each point is the result of measurement with a different thickness absorber [22]. Scattering by the heavy element Pb shows little effect - as expected.

corrections for multiple event scattering were also made.) As expected, the neutrons scatter from the massive Pb atoms with little change in mean energy. For the lighter atoms Al and C, considerable energy transfer is indicated.

The results were compared with a calculation, by Finkelstein [5], of neutron scattering by a polycrystal, using the Einstein model for the atomic motions. In the Einstein model the atoms are considered to vibrate independently at a determined frequency and thus to be oscillators whose energies are integer multiples of an Einstein quantum energy (E_q), which can be estimated from data on the specific heat. In scattering the neutron can create or annihilate one or more quanta with consequent change in its energy. For Pb and Al multiple-quanta transitions predominate; for the two carbon specimens the scattering is mostly zero-quantum (elastic) with about 20% single-quantum. The scattered spectra so calculated can be used to generate Cd transmission curves.

For Pb the effects are small; the agreement is satisfactory but not very significant. For aluminium and the two forms of carbon, agreement was obtained with values of E_q , which were compatible with specific heat data. At room temperature aluminium is in a "classical" regime ($E_q \ll kT$) and graphite and diamond are in a quantum regime ($E_q = kT$), so the results here are very satisfactory.

Further calculations were made for the very unrealistic model in which the specimens were considered as ideal gases at room temperature, with atomic masses 12 for C, 27 for Al and 207 for Pb. The continuous spectra obtained for Pb and Al were very like the histogram spectra for the Einstein case, but the spectrum for the forms of carbon were markedly different. Thus the results suggested that details of the dynamical behaviour were not likely to be visible except where single-quantum scattering dominated.

Had available neutron fluxes been smaller there might well have developed a small field of absorption neutron spectroscopy, though it is unlikely that I would then have had the opportunity to give this lecture and to write this report. But events soon overtook the development as will now be discussed.

The Triple-Axis Spectrometer

As recounted earlier, the decision was made in 1951 to develop a neutron spectrometer which employed Bragg reflection by two single crystals as the monochromating units. The beams were to be two inches square, larger than with existing instruments. Where distances were short, the angular resolution was to be defined by Soller slits. The concept required low backgrounds and thus heavier shielding than was then employed. Monochromators would clearly have to be more efficient than the existing NaCl ones, so a program for growing large metal crystals was instituted, which focused for the moment on lead and aluminium. Hurst was embarking on a low-temperature program, which looked forward to studies of the rare gas liquids, especially liquid helium. Chalk River was already well-supplied with liquid nitrogen; after some abortive attempts, a "Collins" Helium Liquefier was eventually installed. In 1952 an experienced low temperature physicist, David G. Henshaw arrived and took over major responsibilities for the crystal-growing and liquefier programs.

A primitive triple-axis spectrometer was set up at NRX in 1952. The intensities were too low for practical work, though the elastic peak from paraffin wax was seen and probably also that from vanadium. But in November 1952 the reactor suffered an accident and all experimental work terminated until the summer of 1954. Meanwhile Henshaw and Jack Freeborn had been successful in growing large single-crystal ingots of aluminium and lead. So that when work resumed at NRX both the powder diffractometer and the triple-axis instruments were empowered by much superior monochromators. Hurst and Henshaw embarked on studies of the rare gas liquids, instituting an ongoing program which, in successive forms and hands, continued for over 40 years.

The initial form taken by the spectrometer is shown in Fig. 3. The specimen is mounted on an indexed table which translates along the direction of the "monochromatic" neutron beam from the initial monochromator. Another single-axis spectrometer [7] which views the specimen through Soller slits, translates along rails parallel to the reactor face. The angle of scattering is calculated by triangulation and hence is changed only on occasion.

The triple-axis program met with almost immediate success. Some *ad hoc* additions to shielding were added, but otherwise the apparatus performed as expected. See Fig. 3. A variety of experiments were performed, some guided by existing theory and some not. A contributed paper, which turned into an invited paper [24], was given at the annual meeting of the American Physical Society in New York City in January, 1955. Preliminary results were presented for scattering from liquid and solid Pb, water, heavy water, vanadium and from certain paramagnetic materials with differing characteristics, including MnSO_4 , Mn_2O_3 , and MnO .

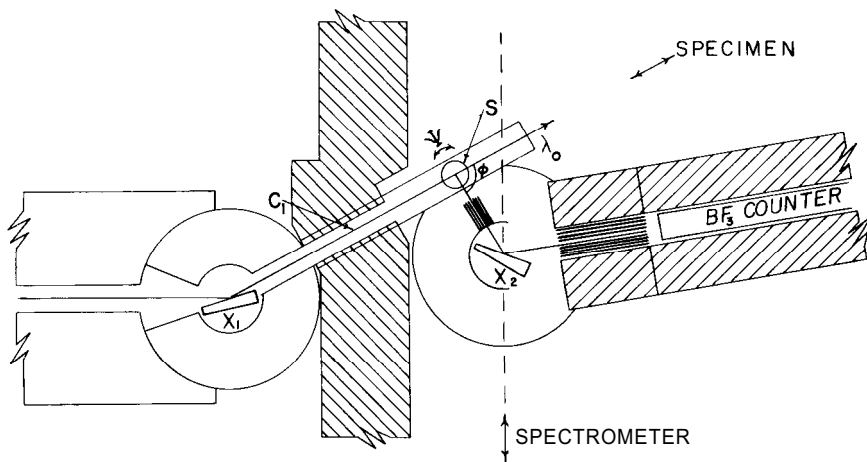

Fig. 3: The first crude version of the triple-axis crystal spectrometer [24 - 26]. Monoenergetic neutrons are selected by the large single crystal monochromator (X1) and impinge on the specimen (S), which is located on a table whose orientation (ψ) in the horizontal plane can be selected. This table can be moved along the direction of the incident beam as desired. The analyzing spectrometer, which employs crystal X2, is a diffractometer (of especially large aperture) which can be translated as a unit; the angle (ϕ) through which the examined neutrons are scattered is determined by triangulation.

Several of these projects were continued and eventually reached publication, the first being the results for the two paramagnetics MnSO_4 and Mn_2O_3 [25]. MnSO_4 has a susceptibility fairly obedient to the Curie Law and hence it is expected that the interactions between the Mn^{++} ions are small; for the same reasons it was expected that the diffuse magnetic scattering should be almost elastic. In fact the scattering at angles smaller than the Debye-Scherrer lines had virtually the same energy width as the incoherent elastic scattering from vanadium. For Mn_2O_3 on the other hand there was substantial inelastic scattering with energy width consistent with a calculation of Van Vleck (15). Similar results were obtained for MnO , in which the energy-widths correlated with the short range order indications in the diffraction pattern. These latter results, continued successively with P.K. Iyengar and R.S. Weaver, did not get properly published, but were reported in review papers - perhaps constituting a kind of virtual publication?

From the beginning our program had been directed towards study of the frequency/wave number (energy/momentum) dispersion relation of the

normal modes (lattice vibrations) in crystals, by means of study of the one-phonon scattering. (By analogy, it was assumed that spin waves in magnetic crystals could also be studied, as turned out to be the case.) In 1954 a theoretical paper by Placzek and Van Hove (9) discussed the phonon experiment in detail. More importantly, for us, they proposed a different kind of experiment, to determine the frequency distribution of the normal modes from the incoherent one-phonon scattering by a cubic crystal with one atom per unit cell. From a practical point of view, vanadium is the only natural element which is a candidate for this experiment, which was added immediately to our program.

Such an experiment was carried out [27] on the primitive triple-axis installation of Fig. 3, with the results shown in Fig. 4a. A strong elastic peak whose intensity decreases with increasing temperature, is visible - as expected from

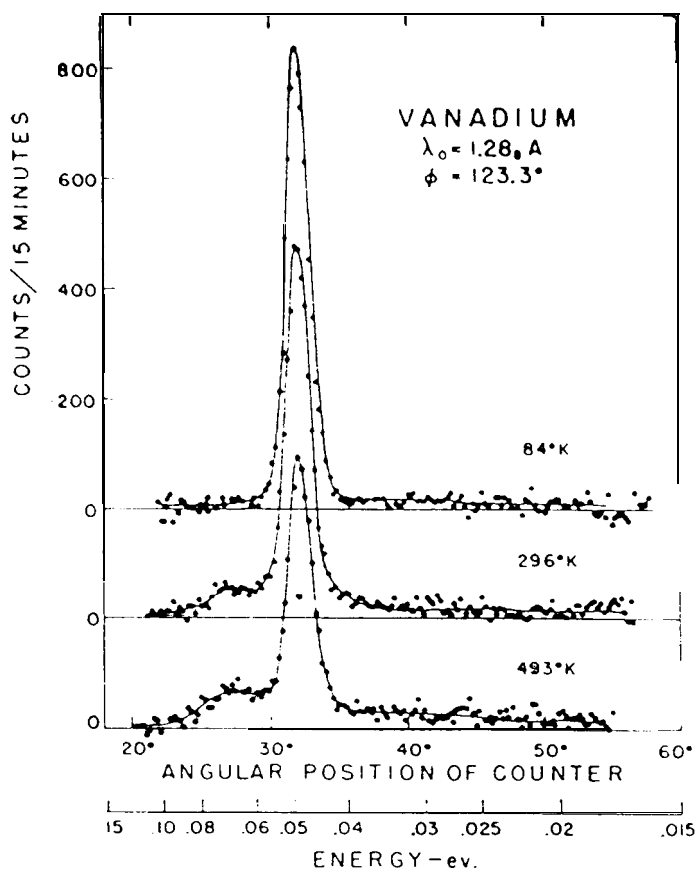

Fig. 4a: Measured energy distributions of neutrons scattered by vanadium as functions of the angular settings of the analyzing spectrometer, for three temperatures, with backgrounds subtracted and intensities normalized [27]. The intensity of the elastic peak decreases with temperature in about the manner expected from Debye-Waller theory. The inelastic component is affected by the extreme dispersion of neutron spectrometers and requires transformation to a true energy distribution.

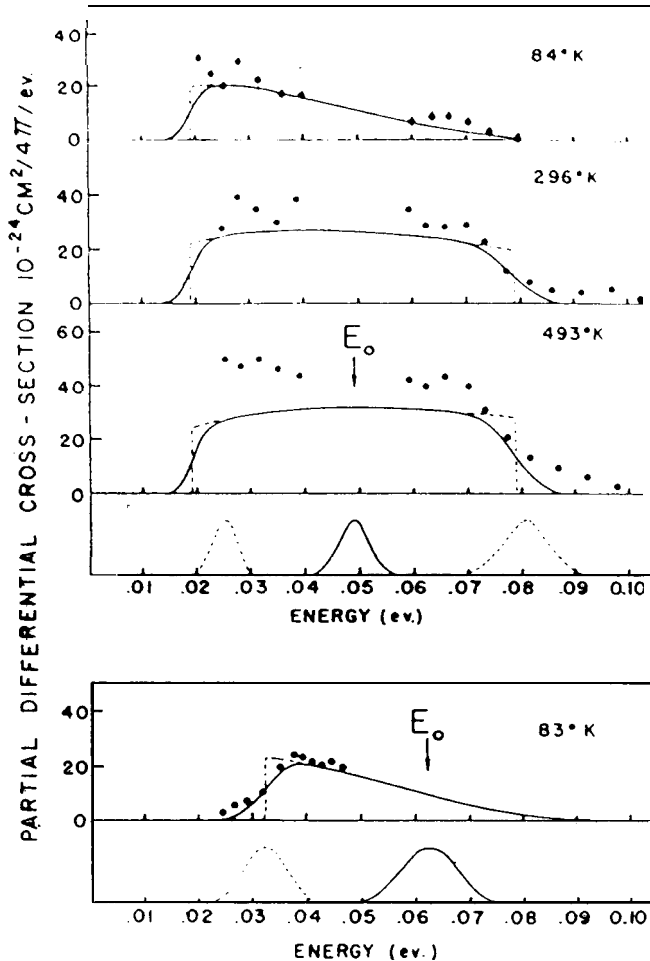

Fig. 4b: The transformed energy distributions (points) of the inelastic component in vanadium (Fig. 4). The curves are calculated (one-phonon) cross-sections for a Debye frequency distribution for the lattice vibrations. The elastic component provides a measure of the resolution function at the incident energy.

a Debye-Waller thermal cloud of increasing size. A weak inelastic component, whose intensity increases with increasing temperature, is also visible; it is this in which we are mainly interested. When this component is transformed from the distribution in (analyzer) angle to a distribution in energy, the curves of Fig. 4b are obtained. An Einstein model can be ruled out by inspection. One-phonon distributions calculated on a Debye model, with Debye temperature consistent with the Debye-Waller behaviour of the elastic peak, are also shown. (The additional scattering can reasonably be attributed to multi-phonon processes.) Thus the experiments supported the structure of the theory but the resolution did not permit improving upon the Debye model for the frequency distribution of the normal modes. Later experiments, using the filter-chopper method, by Stewart et al [32] at Chalk River and by Eisenhauer

et al [31] at Brookhaven, showed plainly structure in the frequency distribution, indicating [see M - O] realistic structure for the lattice vibrations beyond the capabilities of a Debye model.

Least guided by theory and arguably the most important, were the experiments on liquids, particularly those on light and heavy water [33]. Here quasi-elastic scattering was found, whose energy widths could be qualitatively related to the manner in which diffusion went on in the liquid. Analogs to the Debye-Waller factor for the quasi-elastic component and the energy widths of the inelastic components in the scattering could be related to more general aspects of the thermal motions of the molecules. In the later work, by the author and by Sakamoto et al [33], a high-resolution rotating crystal spectrometer was employed, as well as the triple-axis instrument. The developments by Van Hove [13], of generalized (space-time vs momentum-energy) correlation functions, contributed to thinking about this notoriously difficult area, the physics of liquids.

The phonon experiment envisaged from the beginning - almost the *raison d'être* of the program - was carried out on a large single crystal of aluminium, by Brockhouse and Stewart [28]. This material was selected for technical reasons: Al has little neutron capture and incoherent scattering and the coherent scattering cross section is small, so the physical size can be large without leading to large multiple scattering effects. And we had the crystal! The first results were obtained on the early crystal spectrometer with its fixed angle of scattering. The crystal was oriented with its (110) plane in the plane of the spectrometer and was turned a few degrees about an axis normal to that plane, to carry out successive experiments in successive orientations, as shown in Fig. 5. Neutron groups, with the expected properties of one-phonon

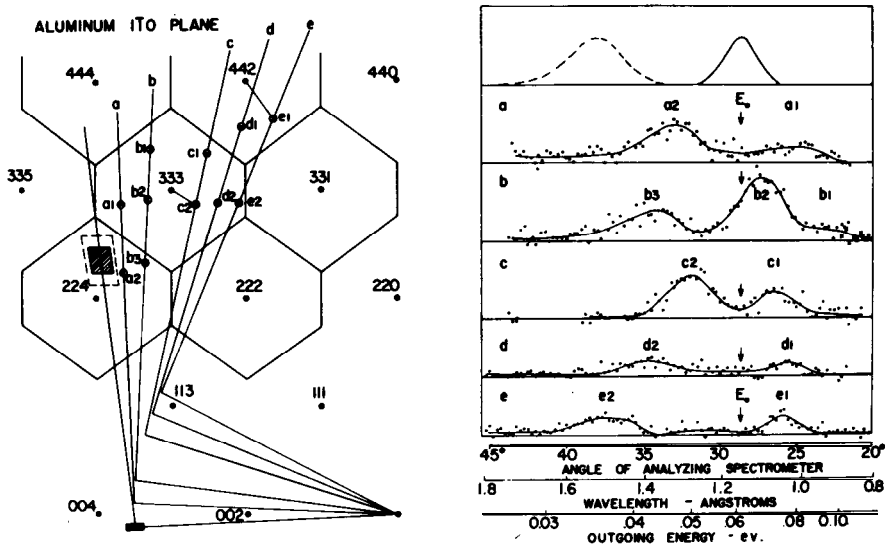

Fig. 5: Phonons in aluminium at room temperature [28]. (a) Some measured distributions in the (1,1,0) plane of a single crystal at a fixed angle of scattering of 95.1 deg. (b) The reciprocal lattice for the (1,1,0) plane with the crystal momenta plotted for the experiments in (a). One typical case is shown in detail as well as a crude depiction of the resolution in momentum.

groups, are observed in the different experiments, at different settings of the analyzing spectrometer and with different intensities. (Multi-phonon scattering would show a continuum.) From the momentum diagram the wave vector (q) of a phonon can be deduced and from energy conservation its frequency (ν). From a number of phonons with q in the same direction it can be made plausible (not shown) that the phonons obey a frequency/wave vector dispersion relation.

The experiments were continued on the differential filter-chopper as well as on the triple-axis apparatus, some 210 phonons distributed over two symmetry planes of the crystal's momentum space (reciprocal lattice). The results permitted refutation of the simple models for the interatomic forces then extant. The Born-Von Kármán theory itself can be taken to be phenomenological with innumerable possibilities for parameters, and thus hardly capable of refutation. If taken literally, as involving forces between ions in the crystal, then already these early results show surprisingly long-range behaviour for the interatomic force system. In the work intensities were used to assign polarization to phonons in symmetry directions. Henceforth measurements were made in symmetry directions as far as possible, in order to reduce the difficulties of analysis.

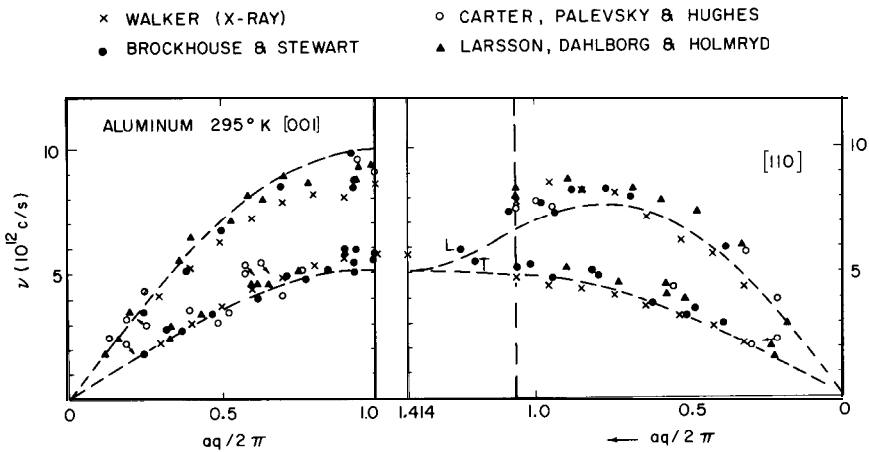

Fig. 6: Dispersion curves for aluminium at room temperature, for two symmetry directions in the crystal (collected results [28 - 30]). The neutron measurements from three laboratories are consistent with each other within the errors and are almost so with those inferred [18] from intensities of scattered X-Rays. Nevertheless the discrepancies would be very important in attempts to extract inter-atomic forces from the data.

Dispersion curves for the phonons in two symmetry directions of single crystalline aluminium are shown in Fig. 6, as determined in the above experiments and by Carter, Palevsky and Hughes at Brookhaven [29] and by Larsson, Dahlborg and Holmryd at Stockholm [30], both groups using the beryllium filter-chopper method. The various experiments agree within their still substantial uncertainties. Dispersion curves deduced by Walker [18]

from his X-ray intensity measurements are also in substantial though not complete agreement. Because the frequencies from neutron experiments are deduced directly from the conservation rules, while those from X-rays require difficult calibrations and corrections, the neutron frequencies are believed to be the more reliable in principle.

Experiments were carried out to study spin waves ("magnons") in single-crystal magnetite (Fe_3O_4). This cubic ferrite ("lodestone") was selected because large single crystals of natural origin were available. It was expected that a more or less isotropic, quadratic dispersion curve would be found at small wave vectors, close to positions in reciprocal space where strong Bragg scattering occurred. This was indeed found [39] to be the case. In a later experiment [39] it was verified that the neutron groups concerned showed the change of intensity expected when a suitable magnetic field was applied and thus that the quanta concerned were indeed magnons and not phonons.

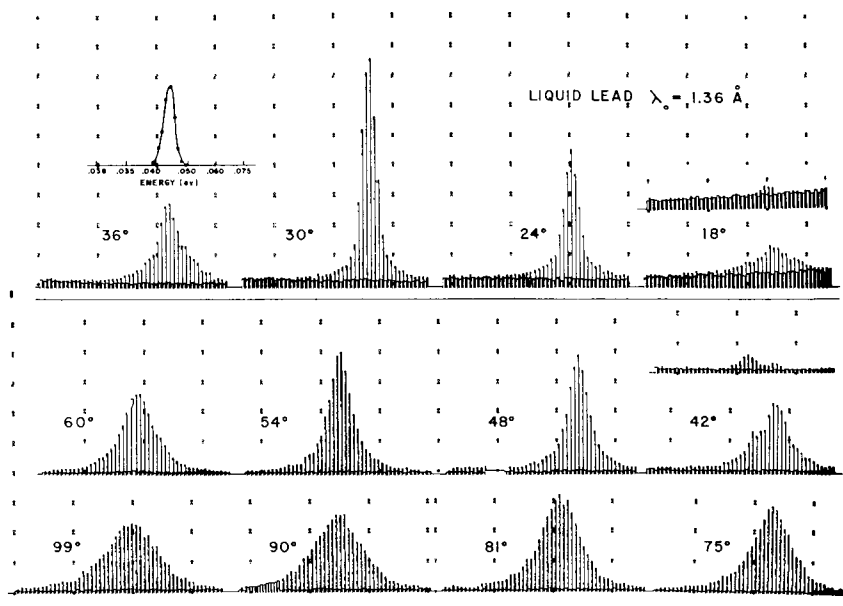

Fig. 7: Histogram, [43] of energy-analyzed distributions of neutrons scattered by liquid lead at a series of scattering angles [34]. The scattering angles are roughly related to the momentum transfer Q the abscissa angles to the energy transfer. Appropriate measured backgrounds are also given. The resolution function measured with a vanadium scatterer is shown at the upper left.

Early results for liquid lead were not easily analyzable. Because of the large mass of the Pb atom, the energy transfers are small. The narrow inelastic component would not be separable from a quasi-elastic component, if the latter existed, because of the instrumental energy resolution. So the early results were never published, though they were presented at Conferences. But with much improved facilities available, new measurements (Fig. 7) with Noel K. Pope [34] were analyzed using the Van Hove [13] transformations to give directly the self and pair correlation functions of the atoms in liquid

lead (Fig. 8). The temporal development of these functions, from the defined origin at $t=0$ to the vanishing of correlation some ten pica-seconds later, provides a sort of statistical "movie" of the atomic motions in the liquid.

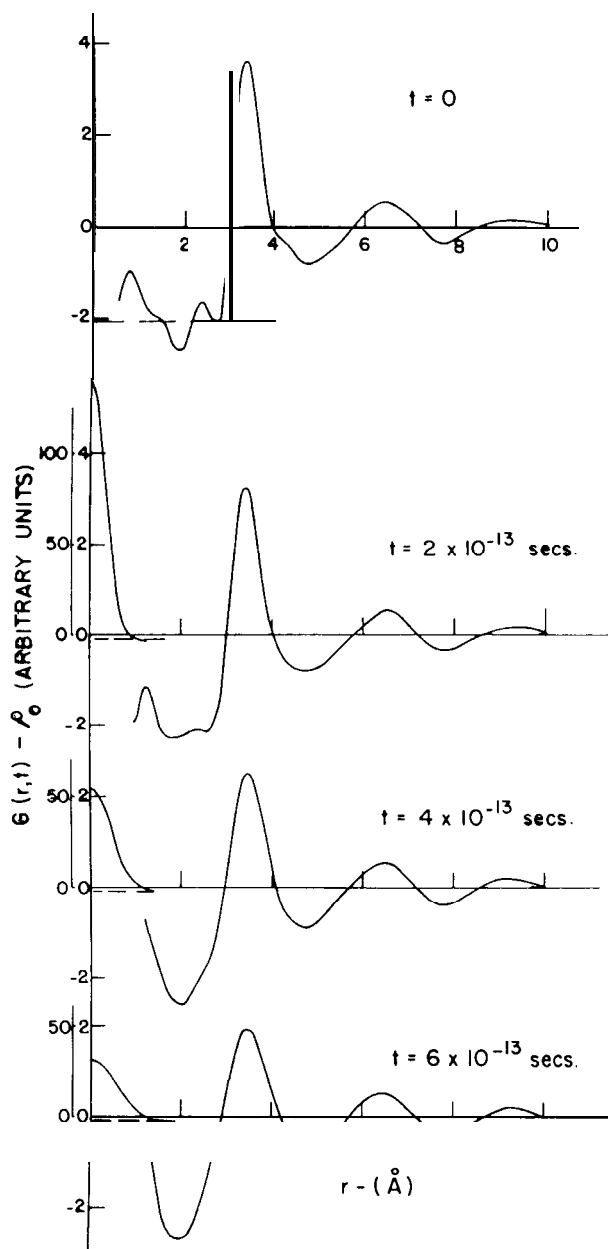

Fig. 8: Van Hove transformations of the data of Fig. 8 [34]. The distribution for time $t=0$ is essentially the familiar pair distribution of X-Ray scattering experiments. The peak (δ -function) at the origin gradually diffuses outwards with elapsed time t as do the first and subsequent neighbour peaks in a sort of moving picture of what goes on in the liquid.

In a wide-ranging memoir such as this, it would not be right to omit mention of the work [35 - 381 on liquid helium, even though I had little part in it. From early on, Henshaw and Hurst had looked forward to including study of the inelastic scattering of neutrons by liquid He as part of their program on the rare gas liquids. But the experiment looked formidable, both as to execution and analysis of results. This appraisal changed abruptly with the publication of a theoretical paper by Cohen and Feynman [35], who predicted a "line" spectrum instead of the continuous spectrum of unknown behaviour which had been assumed. Preparatory work was immediately started. Palevsky, Otnes and Larsson [36], at Stockholm, found the predicted line ("roton") spectrum, using the Beryllium-Chopper method. This was followed closely by work by Yarnell et al [37] and by Henshaw [38], improving and extending the Stockholm results. At Chalk River work has continued on various aspects of liquid helium physics almost to this day.

Developments in Apparatus and Methods

In 1956 the instrument had been completed by construction (by the Engineering Design Branch at Chalk River), of a proper analyzing spectrometer which was set upon the arm of the original [7] single-axis instrument, whose "half-angling" table now carried the specimen. With this new triple-axis instrument, all variables were motor-driven except the initial monochromator on the first (fixed) axis. Thus the initial energy was changable only by changing the monochromator. When the spectrometer was moved to the NRU reactor in 1959 the first axis was also engineered (by W. McAlpin) so that the initial energy (E_0) was also controllable within an experiment. Fig. 9 shows the spectrometer in place at hole C5 of the NRU reactor. Fig. 10 shows a schematic diagram of the arrangement. It might be noted that the relative arrangement of the incident and outgoing beams has importance because of correlations which affect the resolution in momentum space.

In all the work the intensity of the incoming neutron beam is monitored by means of a "thin" neutron detector of known efficiency. In the experiments so far discussed, it was the analyzing spectrometer which was changed and consequently the outgoing energy (E') which was varied. Corrections to the intensities for the efficiency of the analyzer had to be made. For a crystal spectrometer these are not readily calculable, so suitable auxiliary measurements were often required. If the analyzer is kept fixed, its efficiency does not enter the problem unless absolute partial differential cross-sections are desired. So from 1959 on distributions were often measured at constant outgoing energy.

It had been recognized in crystallography that wave-vector (momentum) transfers, not the angles of scattering and crystal orientation, were the "natural variables". This had shown up also in our original consideration, in 1950 - 51, of the theoretical analysis by Weinstock [19] and others, of the scattering by phonons in crystals. Over the years it came to seem obvious that the



Fig. 9: Photograph (1959) of the original triple-axis spectrometer at the NRU reactor at Chalk River. The bank of 52 rotary switches, preset to go through an energy scan of up to 26 points, can be seen in the upper-centre. One of the three variables involved would traverse linearly through the domain of settings desired, while the other two advance nonlinearly according to the settings of the appropriate switches. (AECL photo)

neutron, in scattering, conserved energy and momentum with the specimen scatterer - the transferred momentum (Q) might be carried by the specimen as a whole or by entities within it or by a combination of the two. The specimen being so large, the energy transferred ($\omega = E_0 - E'$) is inevitably carried by the quasi-particle entities within it. When no such entities are involved, the scattering is "elastic". So in thinking about an experiment, one can start with energy-momentum (ω, Q) conservation, not have to reach it at the end of a calculation. This point of view was re-enforced by the evocative Van Hove transformations. The intensities are then governed by a generalized structure factor analogous to the structure factors of neutron and X-ray crystallography. Of course, as for quasi-elastic scattering, some care must be used, in such a semi-classical approach, that the necessary internal entities are considered.

This was the era of the early development of digital computers. Chalk River obtained such a facility about 1954; programs written in a predecessor of Fortran could be run on the Datatron to print out "hard copy" results of a sequence of calculations. The calculations could provide a sequence of angular increments of the variables of a triple-axis spectrometer: the angles of the analyzer and the initial monochromator, the angle of scattering and the angular setting of the specimen in the plane of the spectrometer. Fig. 10 shows the schematic diagram.

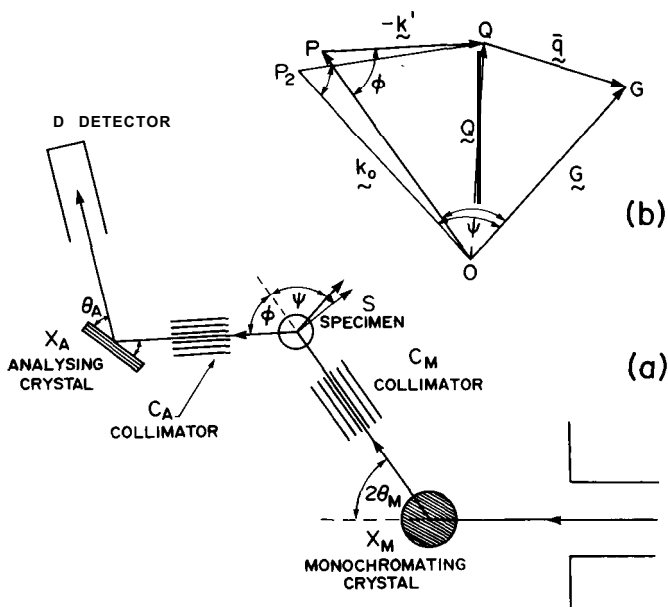

Fig. 10: Schematic drawing of a triple-axis spectrometer together with the momentum space diagram in the same co-ordinate system. The dashed lines indicate a second point on a "Constant Q " curve at fixed incoming energy [43]. The massive shielding required, particularly around the monochromator, is not shown.

In operation one variable would be held constant, one variable moved linearly in constant increments; the other two variables would move non-linearly in the increments provided by the computer. Initially these were set by means of 52 rotary switches which can be seen in the upper centre of Fig. 9. Thus an experiment ("scan") could involve up to 26 points. A stepping switch would accept the two instructions in sequence and match them with the number of microswitch closings by the angular variables concerned. The overall angular traverse was set by the number of increments traversed by the angular variable using fixed increments. This system, largely designed by E.A. Glaser, was brought into operation in 1959. A bit later a system designed by W.D. Howell, which employed punch tape put out by the computer to transport the data to the spectrometer, was in turn installed. Fig. 10 shows the initial arrangement for a scan in which the analyzer setting would be changed linearly and the angular variables set to give the desired momentum transfer. A second setting is indicated for a second point on the scan. And so on.

The method can be thought of in optical analogue. There is an incoming beam of "green" neutrons and the analyzer goes through a "rainbow" sequence, the angular variables meanwhile being changed sequentially to keep the momentum transfer Q constant. Alternatively the analyzer is set to detect "green" neutrons and the incident neutrons go through the "rainbow" sequence. In the simple theory the results are equivalent, but technical matters may favour one over the other.

The variables momentum transfer Q and energy transfer ω are often given in units of Planck's constant \hbar and are then referred to as wave vector and (angular) frequency respectively. The frequency ν is then equal to $\omega/27\pi$

Subject to some geometrical limitations, an experiment could in principle be carried out over any track in Q - ω space. But the most useful has been the "Constant- Q " or constant momentum transfer method. (The method of constant energy transfer has also been used, especially for steep dispersion curves.) The major advantage of these methods [43] is, of course, that the experimenter can get the data wanted for the analysis proposed, rather than having the experiment turn up what might be a great deal of unwanted data. Of course, also, there is a downside to this - something unexpected might be missed. Good practice thus involves giving in any report the value of the fixed variable, usually the incident or outgoing energy, even though it does not appear explicitly in the analysis. (It may affect contaminant scattering.) There is another important virtue of the Constant- Q method: for important technical reasons, the accuracy is greater and the intensities are more easily interpretable than with ordinary neutron spectrometry. (These facts are connected with the occurrence of the Waller-Fröman Jacobian [17] in the theory.)

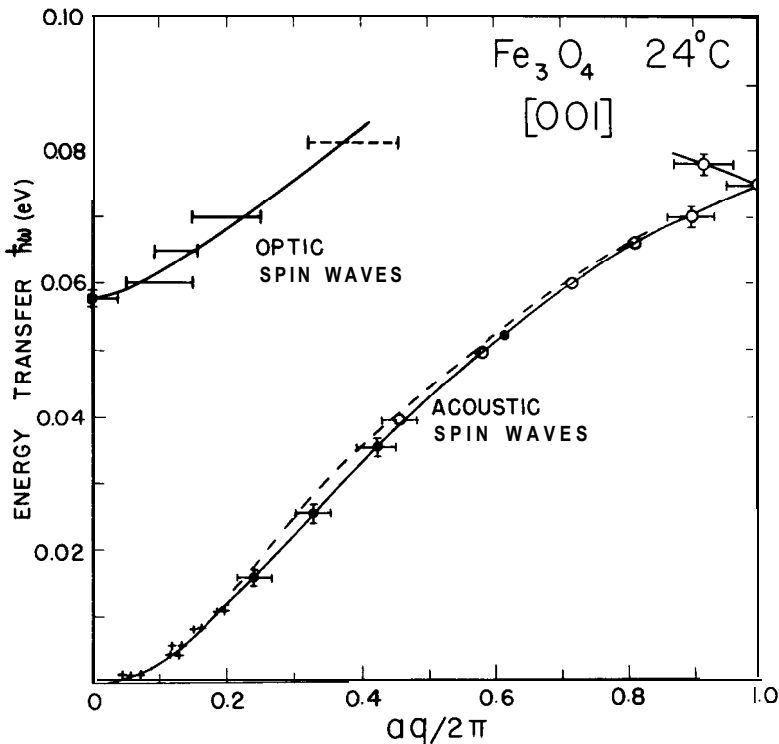

Fig 11: Dispersion curves for spin waves in a magnetite (Fe_3O_4) crystal [40], showing the expected initial quadratic behaviour and the initial part of an optical mode.

With the advent of the Constant-Q ability and the considerable improvements brought about by the move to the new NRU reactor, experiments with much improved resolution and precision were possible. Technical advances were now concerned with making more precise certain "rules of thumb" regarding selection of points in momentum space for optimum resolution, discrimination between different symmetry types of neutron groups, and so on. Of course, as new components became available, such as ^3He proportional counters and better monochromators, these were eagerly adopted.

Using the new methods and the improved facilities at NRU, Watanabe and Brockhouse [40] were able to extend considerably the earlier work [39] on the spin waves in magnetite. See Fig. 11. The complete "acoustic" dispersion curve was obtained as well as part of an "optical" branch near the zone centre, both in qualitative agreement with theoretical expectations [4, 40].

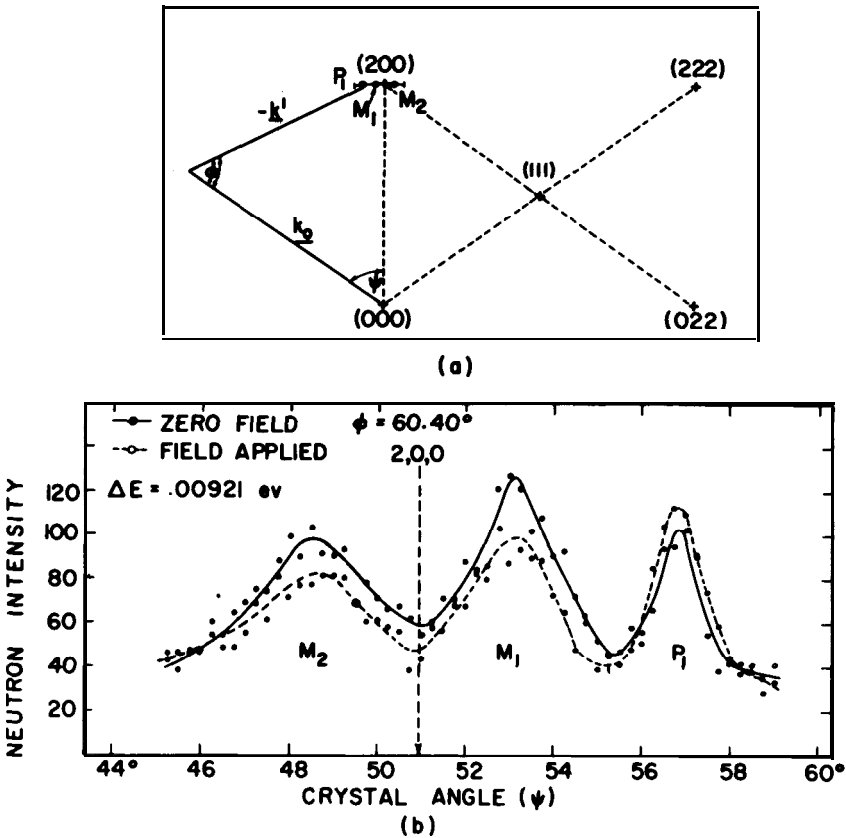

Fig. 12: Momentum diagram (a) and neutron groups (b) for a crystal of (F.C.C.) Co (8% Fe). The magnetic signatures on the intensities indicate that M_2 and M_1 are groups for spin wave quanta (magnons) and that P_1 is a phonon group [41].

At the time it was still an open question whether spin waves existed in metals. Sinclair and Brockhouse [41] studied the neutron scattering in a FCC cobalt-iron alloy (8% Fe). (This crystal was available for use as a neutron polarizer. The magnetic and nuclear scattering are comparable and this fact over-rode the considerable objection that Co has a large capture cross section for neutrons.) The rather steep spin wave dispersion curve could be measured only at small wave vectors (to about 20% of the zone centre). See Fig. 12. It was established from the "signature" under an applied magnetic field that the neutron groups indeed represented spin wave quanta (magnons).

Experiments of other types were carried out. The crystal field spectra of a number of rare earth oxides were studied [42], but analysis proved intractable and these will not be discussed here. Watanabe and Brockhouse [40] studied the exchange field splitting in Ytterbium Iron Garnet. And a visiting colleague, L. N. Becca studied rotational modes in a number of organic compounds. But the major target of my program from here on was phonon physics.

Phonons, Dispersion Curves and Interatomic Forces

Already, before the major acquisitions of 1959, there had been phonon studies which, though desirous of improvement in resolution and precision, were fully competent to provide important instruction on the physics of the specimens concerned. The first of these was a study of the lattice vibrations in two symmetry directions of germanium, by Brockhouse and Iyengar [45]. See Fig. 13. The dispersion curves for the acoustic and optical branches in two symmetry directions were

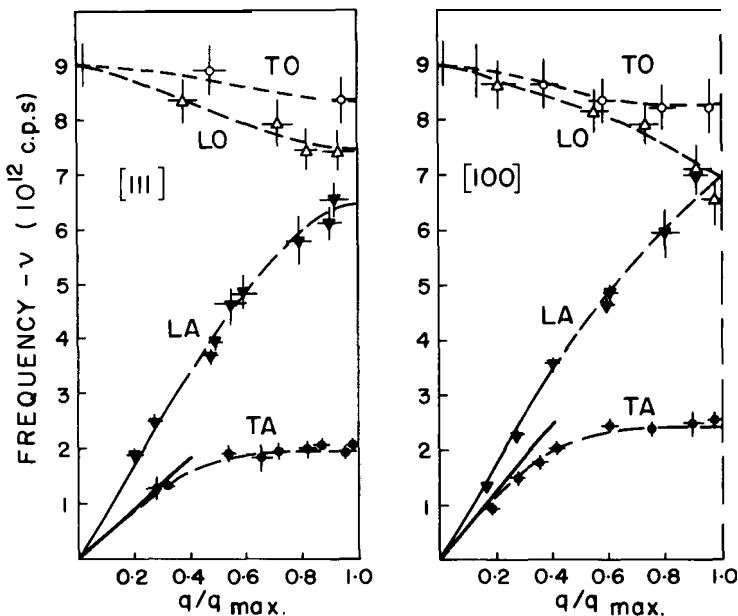

Fig 13: Dispersion curves for germanium at room temperature, showing optical and acoustic branches in two symmetry directions [45].

well delineated and were analyzed in terms of simple interatomic force constant models from the literature, but without complete success, indicating some missing factors in the models. Some elegant connections with far infrared spectra were brought out and the accepted placements of the maximum of the valence band and the minimum in the conduction band were supported. Further experiments were concerned with the phonons in silicon [46], and the homology found to exist with those in germanium, and with the temperature dependence in the phonons in germanium [47]. It should be noted that some results from Brookhaven (using the Filter-Chopper method) are noted in [45].

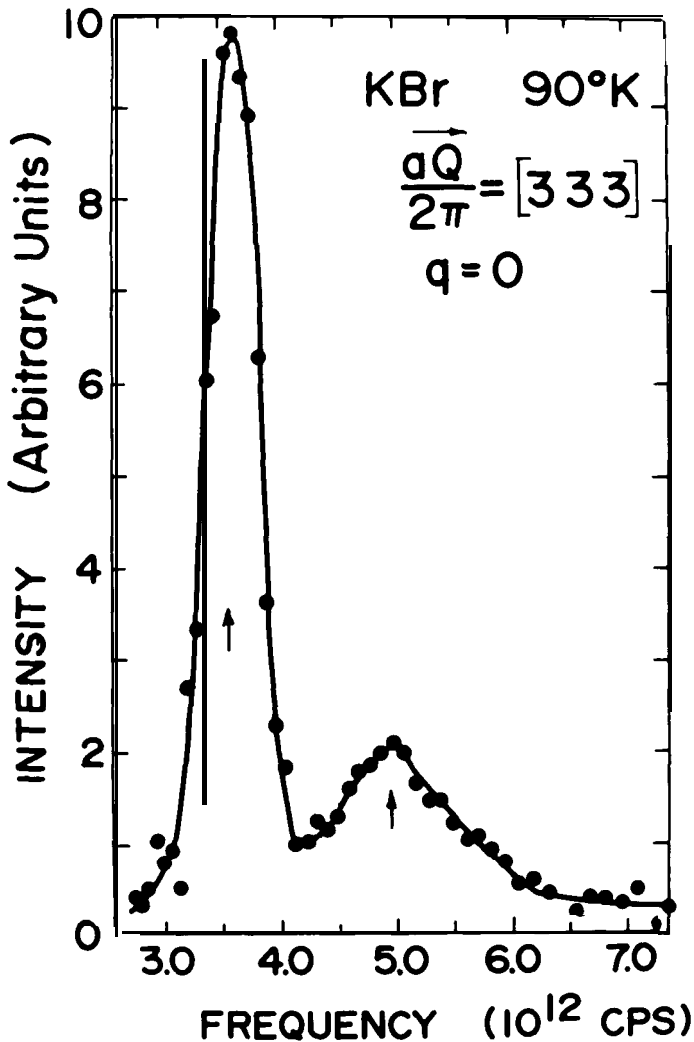

Fig. 14: The zone-centre phonons in a crystal of KBr [50]. The transverse optical mode is active in Infrared spectroscopy but the longitudinal optical mode is not. Both are visible in this neutron pattern and the ratio of their two frequencies is about as predicted from theory [0].

An extensive program was undertaken on alkali halide crystals. In selecting which of these to study, attention was paid to the neutron properties and to the mass ratio between the two component atoms. Two crystals were studied extensively, sodium iodide (NaI) initially [49] and then potassium bromide (KBr) [50]. In the course of this work our visiting colleague, William Cochran invented his famous and useful "Shell Model" for polarizable ions in crystals. One of the results of these studies was the verification of the well-known Lyddane-Sachs-Teller formula [O] for the zone centre optical phonons in terms of the dielectric constants. See Fig. 14.

An extensive program on metals was carried out, with special emphasis on the metal (sodium) then considered to be the "simplest" and on a metal (lead) in which the phonon-electron interaction was known to be appreciable (from the fact that it is a superconductor with high transition temperature). And, as always, an important consideration was the availability of suitable single crystal specimens. We had lead crystals from Henshaw's work on monochromators and Raymond Bowers of Cornell University was able to grow the large crystals of sodium required

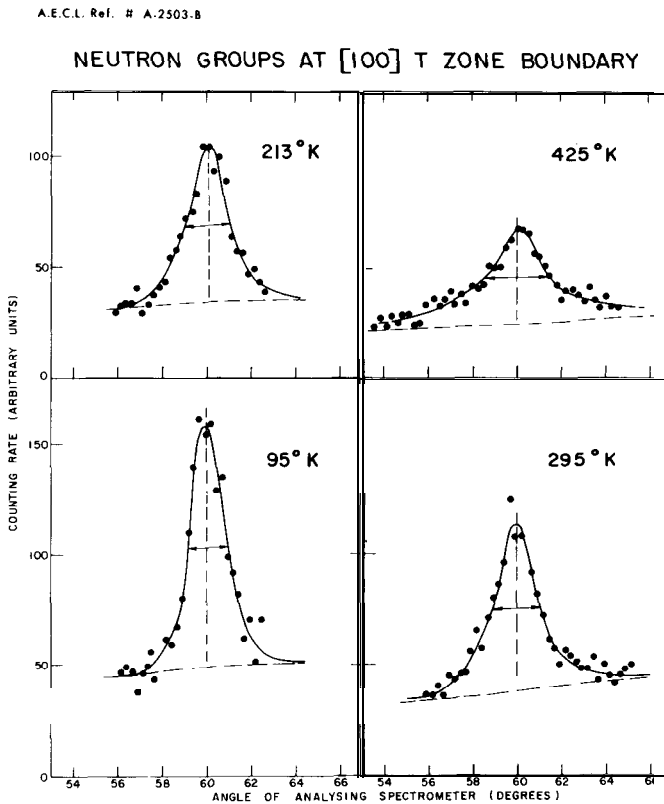

Fig. 15: Neutron groups for a symmetry phonon in a crystal of Pb at four temperatures showing line-widths increasing with temperature [60]. This receives a natural interpretation as a reduction with temperature of the lifetime and coherence length of the phonon involved, because of interaction with other phonons.

Measurements were made on Pb [51] and Na [54], at a low (liquid nitrogen cooled) temperature for all the symmetry directions available including some on the surface of the Brillouin zone. In both cases measurements were made also at higher temperatures, to study thermal broadening and shifts in the phonons. See Fig. 15. Substantial effects were observed, which proved difficult to interpret quantitatively in terms of atomic forces. For both metals at high temperatures, the phonon lifetimes and mean free paths became remarkably short at wave vectors far from the zone centre. Similar results for Al were obtained independently by Larsson et al [30], using the Filter-Chopper method. Our high temperature results received only incomplete or late publication.

Analysis of the results for Pb [51] displayed an interatomic force system of long range and great complexity. Calculations for alkali metals by Walter Kohn [52] suggested that anomalies in the phonon dispersion curves, arising from electron-phonon interaction, might be found at wave vectors related to the Fermi surface of the metal. A series of measurements were made to search for such anomalies in the dispersion curves of Pb. The Kohn anomalies were indeed found [53] in repeated experiments at more or less the expected phonon wave vectors. See Fig. 16. A search was made [54] also in Na (for which the electron-phonon is believed small) without positive result, supporting to some degree the assignment for Pb.

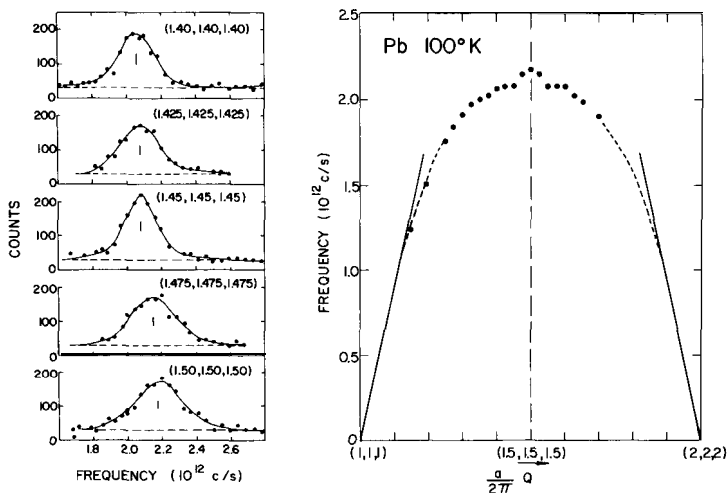

Fig. 16: Kohn Effect in dispersion curves of Pb [53]. (a) A series of closely-spaced phonons show anomalous variation (b) in the corresponding dispersion relation $v(q)$, in this case at a calliper dimension of the Fermi surface in the $[\zeta, \zeta, \zeta]$ direction.

The results of Woods et al [54] for sodium could be analyzed in terms of a Born-von Kármán model of much shorter range than for lead. Dixon et al [55] used the model to calculate the frequency distribution of the normal

modes, which gave excellent agreement with specific heat results from the literature. See Fig. 17. The computer calculation had a resolution capable of showing the topologically significant Van Hove critical points [14] with precision.

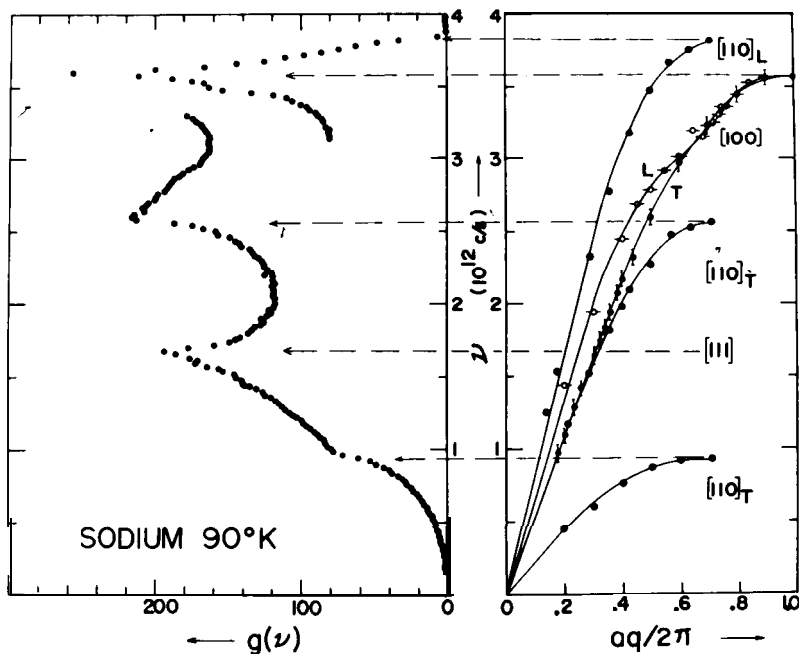

Fig. 17. The frequency distribution $g(\nu)$ for Na at 90 K [55], calculated from a force constant model fitting the dispersion curves $v(q)$ also shown [54]. The relation between the frequencies at symmetry points and the Van Hove [14] singularities in $g(\nu)$ are exhibited.

Finally Fig. 18 shows a comparison of the complete results for (body-centred cubic) Na and those obtained, on the same apparatus by Gilat and Dolling [56], for β -brass (CuZn) ordered with copper mainly on the cube corners and zinc on the body centres. It will be seen how much of the general appearance comes about from symmetry; the effects of what must be considerably different interatomic force systems is for the most part hidden in the fine details. (This is not always the case - Na and CuZn are both (probably) nearly-free electron metals. Drastically different binding schemes can produce much greater effects.) The curves of Fig. 18 point up the effects of the symmetry breaking by the difference introduced by the ordering of the Cu and Zn atoms on the crystallographically equivalent cube corners and body centres.

The results of Figs. 13 - 18 illustrate a basic fact about neutron spectroscopy of crystals. Despite the considerable amount of data shown, it should be realized that vastly more is potentially available in the off-symmetry frequencies and in the intensities of the neutron groups. But presentation and analysis are alike difficult: Presentation, because our intuition and visualization

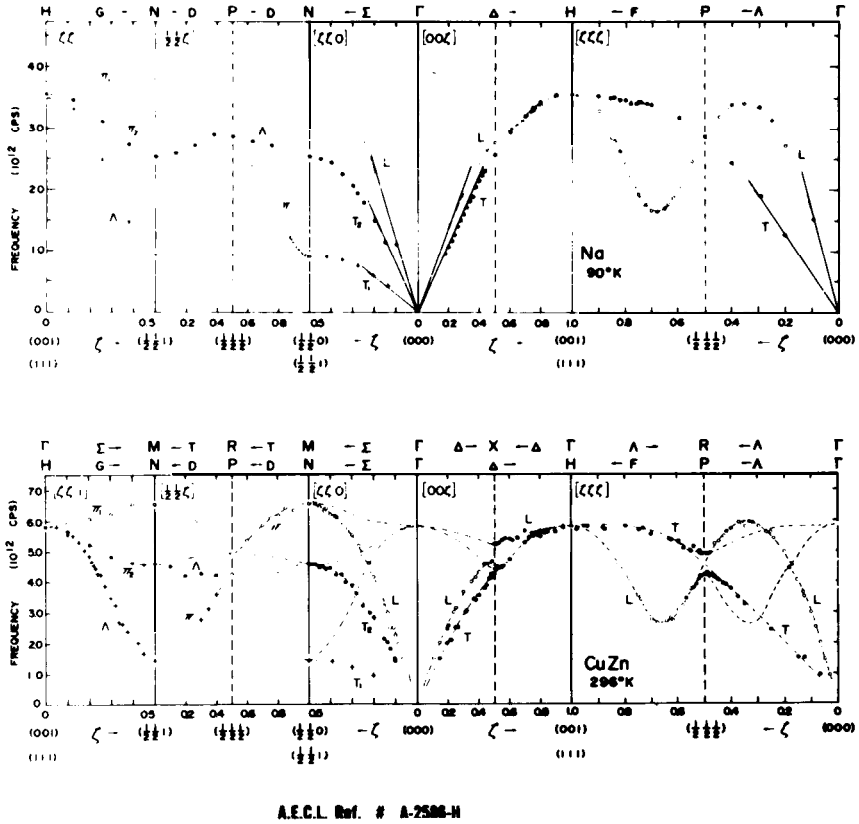

Fig. 18: Complete dispersion curves for the symmetry directions in Na [54] and in ordered CuZn [56]. The group-theoretical notation for the various branches are given as letters. Dashed lines without points represent measurements in symmetry-related directions of the zone.

processes are limited to essentially three spatial dimensions and counted time and the data for crystals with one atom per cell require five dimensional presentation and, for more complicated crystals, still more. Analysis, because it is not possible generally to assign a particular frequency or intensity to a particular formula - there is sorting-out to be done first. Several of the works cited go into this in a small way, via calculations and experimental determinations of dynamic structure factors.

These works and others done over the next few years, were extensively reported in review articles [60 - 63] In these years also comparable results began to appear [48, 57] from other laboratories. The field was now a field in being and not merely in development. My own program, now centred at McMaster University, continued to focus on phonon physics with emphasis on metals and alloys. Reference is made to work [44] by two of my first students there, Eric Svensson and Michael Rowe, on phonons in crystals with

point mass defects. The initial experiments were on single crystals of an alloy of copper with 9.3 Atomic % of gold. The fraction of defects was larger than might be wished but interesting results were obtained, which Svensson and Rowe subsequently improved upon.

Nature, Neutron Spectroscopy and the Grand Atlas

The result of human action is the reward for that action. In physics experimentation we are guided in our choice of action by the existing theory and by calculations based upon that theory. If things turn out as expected the reward is additional confidence in that theory. If the result is not as expected then new possibilities for experimentation and theory-construction are opened up. The early work on neutron physics resulted in little to challenge the basic theories of physics (quantum mechanics in particular) but did, I think, add somewhat to the confidence in which that theory was held. With the models to be found in the literature of the time, the situation was different. I cannot recall a single instance in which experimental results were in quantitative agreement with a pre-existing model calculation. Indeed, the results were usually qualitatively different, but in a manner in which the differences could indicate the ways in which the model needed modification if it were to describe the experimental results. The existing theory normally functioned well as a language in which to discuss the experiments, but had to be extended if it were to describe the results satisfactorily. And only for phenomenological theory, with the possibility of numerous fittable parameters (as the Born-von Kármán theory), would the extension be "trivial".

The fact that theory functioned satisfactorily as a language meant that sometimes there was a possibility to compare directly neutron results with those from other types of experiment (such as infrared absorption) and thus, in a sense, to give an interpretation of the latter. But the major importance of the neutron experiments derives from their influence on the introduction of new microscopic models which can be applied to calculations of other quantities as well. With the vast numbers of "universes of discourse" (physical systems at a particular temperature, under a particular applied pressure and so on) the question arises: how to decide what universes of discourse should be included in the Grand Atlas and to what extent. Chemical and crystallographic structure seem already to have been admitted for any and all such "universes". Are phonons and their dispersion curves and decay descriptions (their "laws"), magnons and their "laws", the numerous other quantum entities and their "laws" to be admitted? Are time-dependent distribution functions also to be admitted? Or are we to act as if the basic theories fully contain all these and that only those quantities are to be considered for inclusion which go to characterize the system? I have had opinions on these matters but that is another story.

ACKNOWLEDGMENTS

In addition to the numerous colleagues who contributed long ago to the work discussed, many of whom are acknowledged in the text and references, I should thank also Atomic energy of Canada Ltd. and McMaster University and several of their members, for help in meeting the many demands arising from this remarkable event. In particular, Mrs. Pat Carter gave assistance with this manuscript and other secretarial necessities. Dr. William Buyers and Dr. Gerald Dolling were helpful in many ways, including provision of quality copies of several figures, especially Figs. 1 and 9, the two photographs.

- A: The Neutron and its Applications, 1982, editor P. Schofield. The Institute of Physics, Bristol and London (Conference Series Number 64), 1983. Also: Pile Neutron Research in Physics. International Atomic Energy Agency, Vienna, 1962.
- B: Fifty Years of Neutron Diffraction, editor G.E. Bacon. Adam Hilger, Bristol, 1986.
- C: Inelastic Scattering of Neutrons in Solids and Liquids. International Atomic Energy Agency, Vienna, 1961.
- D: Inelastic Scattering of Neutrons in Solids and Liquids. International Atomic Energy Agency, Vienna, Vols. I,II: 1963, I,II: 1965; I,II: 1968, 1972.
- E: Proc. of International Conference on Magnetism and Crystallography Vol. II, III: 1961. (Jour. Phys. Soc. of Japan 17: Suppl. B-II, B-III, 1962.)
- F: The Interaction of Radiation with Solids. Editors R. Strumane, J. Nihoul, R. Givers and S. Amelinckx. North-Holland Publishing, 1964.
- G: Neutron Physics, editor M.L. Yeater. Academic Press, New York, 1962.
- H: Solid State Physics, editors F. Seitz and D. Turnbull. Academic Press, London and New York, 1955 - 1994.
- I: Phonons and Phonon Interactions, editor Thor A. Bak. W.A. Benjamin Inc. New York and Amsterdam, 1964.
- J: Phonons in Perfect Lattices and in Lattices with Point Imperfections, editor R.W.H. Stevenson. Oliver and Boyd, Edinburgh and London, 1966.
- K: Thermal Neutron Scattering, editor P.A. Egelstaff. Academic Press, London and New York, 1965.
- L: Magnetic and Inelastic Scattering of Neutrons by Metals, editors T.J. Rowland and P.A. Beck. (Metallurgical Society Conferences, Vol. 43). Gordon and Breach, New York, 1968.

- MONOGRAPHS AND TEXTS -

- M: Properties of Metals and Alloys. N.F. Mott and H. Jones. Oxford University Press, 1936.
- N: The Modern Theory of Solids. F. Seitz. McGraw Hill, New York and London, 1940.
- O: Dynamical Theory of Crystal Lattices. Max Born and Kun Huang. Oxford University Press, 1954.
- P: Neutron Diffraction. G.E. Bacon. Oxford University Press. Editions: 1955, 1962, 1975.
- Q: Scattering of Thermal Neutrons (A Bibliography 1932 - 1974), editors A. Larose and J. Vanderwal. Solid State Literature Guides Volume 7, IFI/PLENUM, New York and London. 1974.

REFERENCES

1. Brockhouse B.N. Slow neutron spectroscopy: an historical account over the years 1950 - 1977. Source A:193-198, 1982.

- PRELUDE OR THEORY -

2. Cassels J.M. The Scattering of Neutrons by Crystals. *Prog. Nucl. Phys.*, editor O.R. Frisch. 1:185-215, 1950.
3. De Gennes P.G. Liquid Dynamics and Inelastic Scattering of Neutrons. *Physica* 25:825-839, 1959.
4. Elliott R.J. and Lowde R.D. The inelastic scattering of neutrons by magnetic spin waves. *Proc. Roy. Soc. (London)* A230:46-73, 1955.
5. Finkelstein R.J. Scattering of Neutrons in Polycrystals. *Phys. Rev.* 72:907-913, 1947.
6. Halpern O. and Johnson M.H. On the Magnetic Scattering of Neutrons. *Phys. Rev.* 55:898 - 923, 1938.
7. Hurst D.G., Pressesky A.J. and Tunnicliffe P.R. The Chalk River Single-Crystal Neutron Spectrometer. *Rev. Sci. Instr.* 21:705 - 712, 1950.
8. Moorhouse R.G. Slow Neutron Scattering by Ferromagnetic Crystals. *Proc. Phys. Soc.* A64:1097 - 1107, 1951.
9. Placzek G. and Van Hove L. Crystal Dynamics and Inelastic Scattering of Neutrons. *Phys. Rev.* 93:1207 - 1214, 1954.
10. Seegar R.J. and Teller E. On the Inelastic Scattering of Neutrons by Crystal Lattices. *Phys. Rev.* 62:37 - 40, 1942.
11. Shull C.G. Wave properties of the neutron. *Source A:* 157 - 168, 1982. *Early Neutron Diffraction Technology. Source B:* 19 - 25, 1986.
12. Squires G.L. Multi-oscillator processes in the scattering of neutrons by crystals. *Proc. Roy. Soc. (London)* A212:192 - 206, 1952.
13. Van Hove L. Correlations in Space and Time and Born Approximation Scattering in Systems of Interacting Particles, *Phys. Rev.* 95:249 - 262, 1954. Time - Dependent Correlations between Spins and Neutron Scattering in Ferromagnetic Crystals. *Phys. Rev.* 95:1374 - 1384, 1954.
14. Van Hove L. The Occurrence of Singularities in the Elastic Frequency Distribution of a Crystal. *Phys. Rev.* 89:1189 - 1193, 1953.
15. Van Vleck J.H. On the Theory of the Forward Scattering of Neutrons by Paramagnetic Media. *Phys. Rev.* 55:924 - 930, 1939.
16. Vineyard G.H. Scattering of Slow Neutrons by a liquid. *Phys. Rev.* 110:999 - 1010, 1958.
17. Waller I. and Fröman P.O. On neutron diffraction phenomena according to the kinematical theory. I. *Arkiv for Fysik* 4:183 - 189, 1952. Fröman P.O. *ibid* II. 4:191 - 202, 1951.
18. Walker C.B. X-Ray Study of Lattice Vibrations in Aluminum. *Phys. Rev.* 103:547 - 557, 1956
19. Weinstock R. Inelastic Scattering of Slow Neutrons. *Phys. Rev.* 65:l - 20, 1944.

- GENESIS -

20. Brockhouse B.N. A Childhood of Slow Neutron Spectroscopy. *Source B:*35 - 46, 1986.
21. Egelstaff P.A. Inelastic Scattering of Cold Neutrons. *Nature* 168:290, 1951.
22. Brockhouse B.N. and Hurst D.G. Energy Distribution of Slow Neutrons Scattered from Solids. *Phys. Rev.* 88:542 - 547, 1952.
23. Lowde R.D. Diffuse Reflection of Neutrons from a Single Crystal. *Proc. Phy. Soc.* A65:857 - 858, 1952. On the diffuse reflexion of neutrons by a single crystal. *Proc. Roy. Soc.* A221:206 - 223, 1954.
24. Brockhouse B.N. A New Tool for the Study of Energy Levels in Condensed Systems (A). Study of Energy Levels in Solids, Liquids and Magnetic Materials by Scattered Slow Neutrons (T). *Phys. Rev.* 98:1171, 1955.
25. Brockhouse B.N. Energy Distribution of Neutrons Scattered by Paramagnetic Substances. *Phys. Rev.* 99:601-603(L), 1955. Jacrot B. Mesure de l'énergie de neutrons tres lents apres une diffusion inelastique par des polycrystaux et des monocristaux. *Compt. Rend.* 240:745 - 747, 1955.
27. Brockhouse B.N. Neutron Scattering and the Frequency Distribution of the Normal Modes of Vanadium Metal. *Can. J. Phys.* 33:889 - 891, 1955.

28. Brockhouse B.N. and Stewart A.T. Scattering of Neutrons by Phonons in an Aluminum Single Crystal. *Phys. Rev.* 100:756 - 757, 1955. Normal Modes of Aluminum by Neutron Spectrometry. *Rev. Mod. Phys.* 30:236 - 249, 1958.
29. Carter R.S., Palevsky H. and Hughes D.J. Inelastic Scattering of Slow Neutrons by Lattice Vibrations in Aluminum. *Phys. Rev.* 106:1168 - 1174, 1957.
30. Larsson K.-E., Dahlborg U. and Holmryd S. A study of some temperature effects on the phonons in aluminium by use of cold neutrons. *Ark. Fys.* 17:369 - 392, 1960.
31. Eisenhauer C.M., Pelah I., Hughes D.J. and Pdlevsky H. Measurement of Lattice Vibrations in Vanadium by Neutron Scattering. *Phys. Rev.* 109:1046 - 1051, 1958.
32. Stewart A.T. and Brockhouse B.N. Vibration Spectra of Vanadium and a Mn-Co Alloy by Neutron Spectrometry. *Rev. Mod. Phys.* 30:250 - 255, 1958.
33. Brockhouse B.N. Structural Dynamics of Water by Neutron Spectrometry. *Acta Cryst.* 10:827 - 828, 1957. *Suppl. Nuovo Cimento* 9:45 - 71, 1958. Diffusive Motions in Liquids and Neutron Scattering. *Phys. Rev. Letters* 2:287-289, 1959. Sakamoto M., Brockhouse B.N., Johnson R.G. and Pope N.K. Neutron Inelastic Scattering Study of Water. *Source E, Suppl. B - II*:370 - 373.
34. Brockhouse B.N. and Pope N.K. Time-dependent Pair Correlations in Liquid Lead. *Phys. Rev. Letters* 3:259 - 262, 1959, Brockhouse (References) May 9/95) # 5 of 7 for "Les Prix Nobel" (1994)
35. Cohen M. and Feynman R.P. Theory of Inelastic Scattering of Cold Neutrons from Liquid Helium. *Phys. Rev.* 107:13-24, 1957.
36. Palevsky H., Otnes K. and Larsson K.E. Excitation of Rotons in He II by Cold Neutrons. *Phys. Rev.* 108:1346 - 1347, 1958. *Phys. Rev.* 112:11 - 18, 1959.
37. Yarnell J.L., Arnold G.P., Bendt P.J. and Kerr E.C. Energy vs Momentum Relations for Excitations in Liquid Helium. *Phys. Rev. Lett.* 1:9 - 11, 1958. Excitations in Liquid Helium: Neutron Scattering Measurements. *Phys. Rev.* 113:1379 - 1386, 1959.
38. Henshaw D.G. Energy-Momentum Relation in Liquid Helium in Inelastic Scattering of Slow Neutrons. *Phys. Rev. Lett.* 1:127 - 129, 1958. Henshaw D.G. and Woods A.D.B. Modes of Atomic Motions in Liquid Helium by Inelastic Scattering of Neutrons. *Phys. Rev.* 121:1266 - 1274, 1961.
39. Brockhouse B.N. Scattering of Neutrons by Spin Waves in Magnetite. *Phys. Rev.* 106:859 - 864, 1957. Field Dependence of Neutron Scattering by Spin Waves. *Phys. Rev.* 111:1273 - 1274, 1958.
40. Watanabe H. and Brockhouse B.N. Observation of Optical and Acoustical Magnons in Magnetite. *Phys. Letters* 1:189 - 190, 1962. Exchange field splitting in Ytterbium Iron Garnet. *Phys. Rev.* 128:67, 1962.
41. Sinclair R.N. and Brockhouse B.N. Dispersion Relation for Spin Waves in a fcc Cobalt Alloy. *Phys. Rev.* 120: 1638 - 1640, 1960.
42. Brockhouse B.N., Becka L.N., Rao K.R., Sinclair R.N. and Woods A.D.B. Crystal Field Spectra in Rare Earth Oxides, *Source E, Suppl. B*:111:63 - 66, 1962.
43. Brockhouse B.N. Methods for Neutron Spectrometry. *Source C*:113 - 150, 1961.
44. Svensson E.C., Brockhouse B.N. and Rowe J.M. "In-Band" modes of vibration of a dilute disordered alloy - Cu(Au). *Solid State Comm.* 3:245 - 249, 1965.

- PHONONS -

45. Brockhouse B.N. and Iyengar P.K. Normal Vibrations of Germanium by Neutron Spectrometry. *Phys. Rev.* 108:894 - 895, 1957. Normal Modes of Germanium by Neutron Spectrometry. *Phys. Rev.* 111:747 - 754, 1958.
46. Brockhouse B.N. Lattice Vibrations in Semiconductors by Neutron Spectrometry. *J. Phys. Chem. Solids* 8:400 - 405, 1959. Lattice Vibrations in Silicon and Germanium. *Phys. Rev. Letters* 2:256 - 258, 1959.
47. Brockhouse B.N. and Dasannacharya B.A. Temperature Effects on Lattice Vibrations in Germanium. *Solid State Comm.* 1:205 - 209, 1963.
48. Yarnell J.L., Warren J.L. and Wenzel R.G. Lattice Vibrations in Diamond. *Phys. Rev. Letters* 13:13 - 15, 1964.
49. Woods A.D.B., Cochran W. and Brockhouse B.N. Lattice Dynamics of Alkali Halide Crystals. *Phys. Rev.* 119:980 - 999, 1957.

50. Woods A.D.B., Brockhouse B.N. and Cowley R.A. and Cochrdn W. Lattice Dynamics of Alkali Halide Crystals. II. Experimental Studies of KBr and NaI. Phys. Rev. 131:1025 - 1029, 1963. Cowley R.A., Cochran W. and Brockhouse B.N. and Woods A.D.B. III. Theoretical. Phys. Rev. 131:1030 - 1039, 1963.
51. Brockhouse B.N., Arase T., Caglioti G., Rae K.R. and Woods A.D.B. Crystal Dynamics of Lead. I. Dispersion Curves at 100 K. Phys. Rev. 128:1099 - 1111, 1962.
52. Kohn W. Image of the Fermi Surface in the Vibration Spectrum of a Metal. Phys. Rev. Letters 2:393 - 394, 1959.
53. Brockhouse B.N., Rao KR. and Woods A.D.B. Image of the Fermi Surface in the Lattice Vibrations of Lead. Phys. Rev. Letters 7:93 - 95, 1961.
54. Woods A.D.B., Brockhouse B.N., March R.H. and Stewart A.T. and Bowers R. Crystal Dynamics of Sodium at 90 K. Phys. Rev. 128:1112 - 1120, 1962.
55. Dixon A.E., Woods A.D.B. and Brockhouse B.N. Frequency Distribution of the Lattice Vibrations in Sodium. Proc. Phys. Soc. 81:973 - 974, 1963.
56. Gilat G. and Dolling G. Normal Vibrations of β Brass. Phys. Rev. 138:A1053 - 1065, 1965.
57. Stedman R. and Nilsson S. Phonons in Aluminium at 80 K. Source D:Vol.I:211 - 223, 1965.

- REVIEWS -

58. Shull C.G. and Wollan E.O. Applications of Neutron Diffraction to Solid State Problems. Source H:Vol.2:138 - 217, 1956.
59. Kothari L.S. and Singwi KS. Interaction of Thermal Neutrons with Solids. Source H:Vol.8:110 - 190, 1959.
60. Brockhouse B.N.' Crystal and Liquid Dynamics from Neutron Energy Distributions. Source G:129 - 144, 1962. Phonons and Neutron Scattering. Source I:221 - 275, 1964. Neutron Scattering by Phonons. Source J:110 - 152, 1966.
61. Brockhouse B.N., Hautecler S. and Stiller H. Inelastic Scattering of Slow Neutrons. Source F:580 - 642, 1964.
62. Dolling G. and Woods A.D.B. Thermal Vibrations of Crystal Lattices. In Source K, editor P.A. Egelstaff. K:193 - 249, 1965.
63. Lomer W.M. and Low G.G. Introductory Theory. In Source K, editor P.A. Egelstaff. K:1 - 52, 1965. Other articles by R.M. Brugger, P.K. Iyengar, S.J. Cocking and F.J. Webb, G. Dolling and A.D.B. Woods, B. Jacrot and T. Riste, A. Sjolander, K.E. Larsson, J.A. Janik and A. Kowalska provide rather complete reports on the state of the field by 1965.