

# NONLINEAR OPTICS AND SPECTROSCOPY

Nobel lecture, 8 December, 1981

by

NICOLAAS BLOEMBERGEN

Harvard University, Division of Applied Sciences, Cambridge, Massachusetts 02138, USA

The development of masers and lasers has been reviewed in the 1964 Nobel lectures by Townes (1) and by Basov (2) and Prokhorov (3). They have sketched the evolution of the laser from their predecessors, the microwave beam and solid state masers. Lasers are sources of coherent light, characterized by a high degree of monochromaticity, high directionality and high intensity or brightness. To illustrate this last property, consider a small ruby laser with an active volume of one 1 cc. In the Q-switched mode it can emit about  $10^{18}$  photons at 694 nm wavelength in about  $10^{-8}$  sec. Because the beam is diffraction limited, it can readily be focused onto an area of  $10^{-6}$  cm<sup>2</sup>, about ten optical wavelengths in diameter. The resulting peak flux density is  $10^{13}$  watts/cm<sup>2</sup>. Whereas 0.1 Joule is a small amount of energy, equal to that consumed by a 100 watt light bulb, or to the heat produced by a human body, each one-thousandth of a second, the power flux density of 10 terawatts/cm<sup>2</sup> is awesome. It can be grasped by noting that the total power produced by all electric generating stations on earth is about one terawatt. (The affix "tera" is derived from the Greek **τέρας** = monstrosity, not from the Latin "terra"!)

Indeed, from Poynting's vector it follows that the light amplitude at the focal spot would reach  $10^8$  volts/cm, comparable to the electric field internal to the atoms and molecules responsible for the binding of valence electrons. These are literally pulled out of their orbits in multiphoton tunneling processes, and any material will be converted to a highly ionized dense plasma at these flux densities. It is clear that the familiar notion of a linear optical response with a constant index of refraction, i.e., an induced polarization proportional to the amplitude of the light field, should be dropped already at much less extreme intensities. There is a nonlinearity in the constitutive relationship which may be expanded in terms of a power series in the electric field components.

$$P_i = \chi_{ij}^{(1)} E_j + \chi_{ijk}^{(2)} E_j E_k + \chi_{ijkl}^{(3)} E_j E_k E_l + \dots \quad (1)$$

Such nonlinearities have been familiar at lower frequencies for over a century. For example, power and audio engineers knew about the nonlinear relationship between magnetic field and induction,  $B = \mu(H)H$ , in transformers and solenoids containing iron. Waveform distortion results (4). Such nonlinear phenomena at optical frequencies are quite striking and can readily be calculated

by combining the nonlinear constitutive relation (1) with Maxwell's equations. In the first decade of this century Lorentz (5) calculated  $\chi^{(1)}$  with the electron modeled as a harmonic oscillator. If he had admitted some anharmonicity, he could have developed the field of nonlinear optics seventy years ago. It was, however, not experimentally accessible at that time, and Lorentz lacked the stimulation from stimulated emission of radiation.

Nonlinear effects are essential for the operation of lasers. With dye lasers it is possible to cover the range of wavelengths from 350-950 nm continuously, including the entire visible spectrum. A variety of nonlinear processes, including harmonic generation, parametric down conversion and the stimulated Raman effects extend the range for coherent sources throughout the infrared and into the vacuum ultraviolet. Thus the field of nonlinear laser spectroscopy could be developed rapidly during the past two decades, aided considerably by previous investigations of related phenomena at radiofrequencies. It is, therefore, appropriate to start this review by recalling some nonlinear phenomena first discovered in the field of magnetic resonance.

## NONLINEAR PRECURSORS IN MAGNETIC RESONANCE

As a graduate student of Professor E. M. Purcell at Harvard University, I studied relaxation phenomena of nuclear magnetic resonance in solids, liquids and gases. A radiofrequency field at resonance tends to equalize the population of two spin levels, while a relaxation mechanism tries to maintain a population difference, corresponding to the Boltzmann distribution at the temperature of the other degrees of freedom in the sample. The reduction in population difference is called saturation. It is a nonlinear phenomenon, as the magnitude of the susceptibility tends to decrease with increasing field amplitude. In 1946 we found that "a hole could be eaten", or a saturation dip could be produced, in an inhomogeneously broadened line profile (6). Figure 1a shows the proton spin resonance in water, broadened by field inhomogeneities of the available magnet. Figures 1b and 1c show saturation of a particular packet in the distribution, which is subsequently probed by sweeping through the resonance with a weaker signal after various time intervals. The disappearance rate of the hole is determined by the spin lattice relaxation time. This was also the first indication of the extremely sharp features of NMR lines in liquids, due to motional narrowing, on which the widespread use of NMR spectroscopy is founded.

If two pairs of levels have one level in common, saturation of one resonance may influence the susceptibility at another resonance. This was also observed early in NMR in spin systems with quadrupole splitting and quadrupolar relaxation (7). The detection of Hertzian resonances by optical methods described by Kastler (8) is another manifestation of this phenomenon. A change in the population of sublevels with different values of the spatial quantum number  $m$ , induced by a radiofrequency field produces a change in the polarization of the emitted light. The Overhauser effect (9) describes the change in population of nuclear spin levels in metals (10) due to an application of a

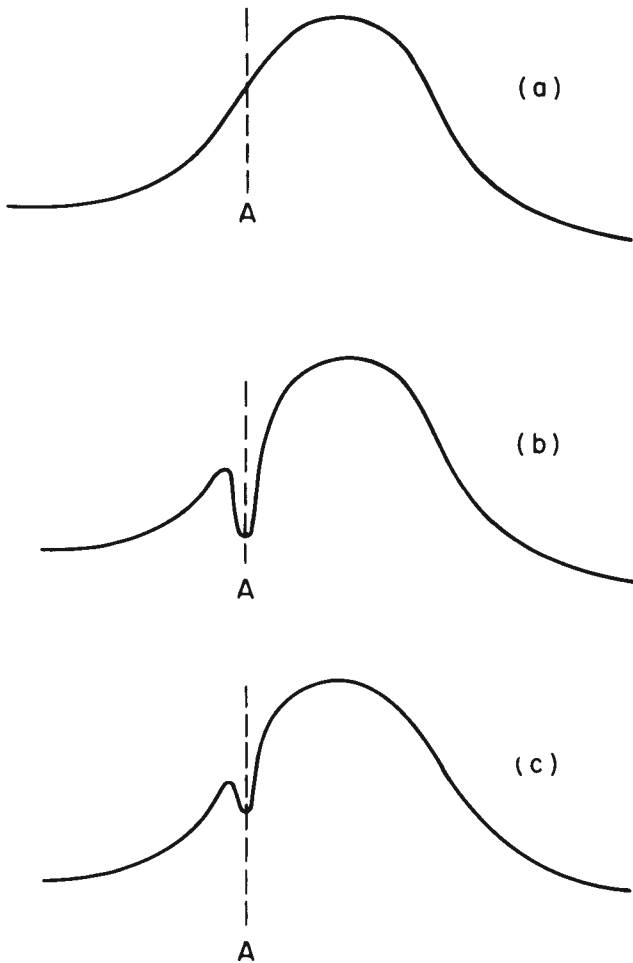

Fig. 1. (after reference 6)

- a) Inhomogeneous broadened profile of NMR in water.
- b) Saturation dip in inhomogeneous profile, observed in 1946.
- c) As in b), but with longer delay between pump signal and probing scan

microwave field at the electron spin resonance. Both optical and microwave pumping methods have been used to obtain nuclear spin polarized targets (11).

It is possible to maintain a steady state inverted population, in which a level with higher energy is more populated than another level with lower energy (12). This pair of levels may be said to have a negative temperature. The principle of the method, displayed in Fig. 2, is based on frequency selective pumping between a pair of nonadjacent energy levels, with the simultaneous action of a suitable relaxation mechanism. The pump tends to establish a high temperature for a pair of levels separated by a higher frequency, while at the same time relaxation maintains a low temperature between a pair with a smaller frequency separation. Stimulated emission will dominate over absorp-

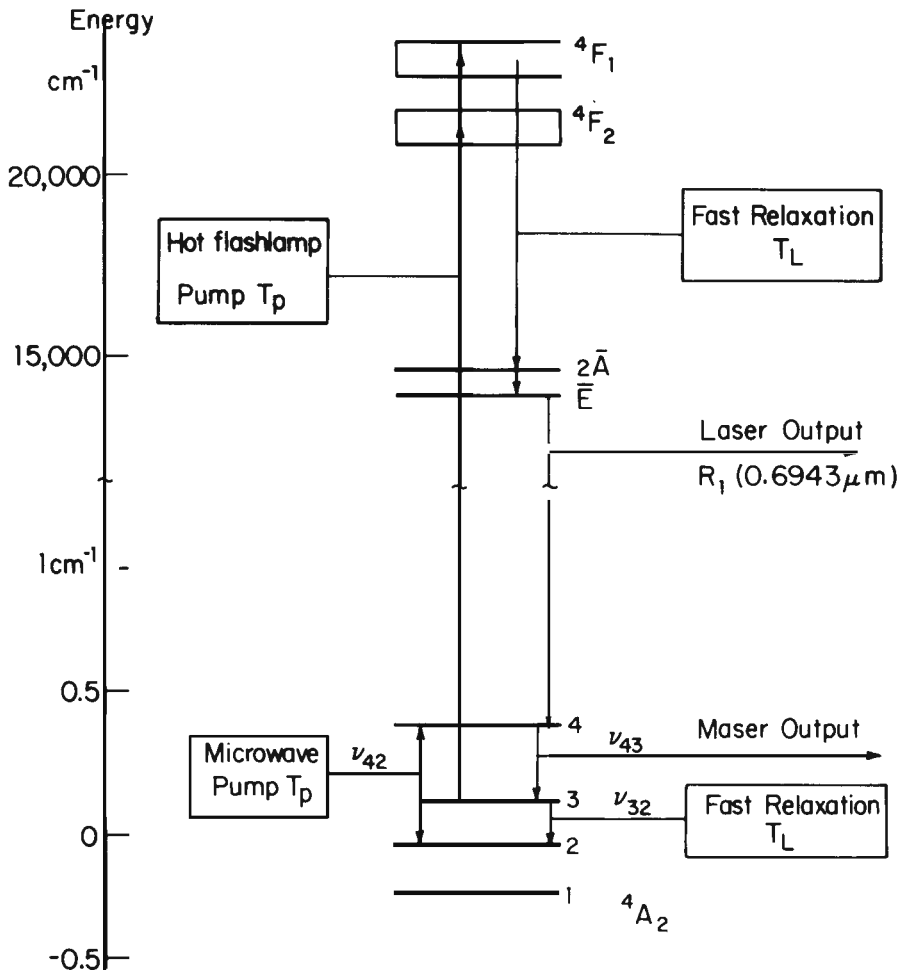

Fig. 2. Energy level diagram of Cr<sup>3+</sup> in ruby. Note change in vertical scale between microwave maser and optical laser action.

tion at the third pair of a three-level system. Basov and Prokhorov (13) had proposed a frequency selective excitation mechanism for molecular beam masers without explicit discussion of relaxation.

The spin levels of paramagnetic ions in crystals are useful to obtain maser action at microwave frequencies. The stimulated emission may be considered as the output of a thermodynamic heat engine (14), operating between a hot pump temperature and a low relaxation bath temperature. These two temperatures occur in the same volume element in space, while in a conventional heat engine there is, of course, a spatial separation between the hot and cold parts. The question of thermal insulation between the paramagnetic spin transitions is based on frequency differences and differentials in relaxation rates. This question was addressed in a study of cross-relaxation phenomena (15), which

determine the heat transfer between different parts of the spin Hamiltonian. It turns out that concentrated paramagnetic salts cannot be used in masers, because no large thermal differentials can be maintained in the magnetic energy level system. As a historical curiosity I may add that the biggest hurdle for me in working out the pumping scheme was the question of how to obtain a nonvanishing matrix element between nonadjacent spin levels. This, of course, is resolved by using states which are a superposition of several magnetic quantum numbers  $m_s$ . This can be obtained by applying the external magnetic field at an arbitrary angle with respect to the axis of the crystal field potential. The multilevel paramagnetic solid state maser is useful as an extremely low noise microwave amplifier. Such a maser, based on the energy levels of the  $\text{Cr}^{3+}$  ion in ruby, was used, for example, by Penzias and Wilson in their detection of the cosmic background radiation (16).

The same principle has subsequently been used to obtain a medium with gain in most lasers. It was incorporated in the basic proposal for an optical maser by Schawlow and Townes (17). It is noteworthy that the first operating laser by Maiman (18) also used the  $\text{Cr}^{3+}$  ions in ruby as the active substance. Of course, a different set of energy levels is involved in the two cases, and the change in frequency scale in the top and bottom part of Fig. 2 should be noted. The amplitude of the laser output is limited by a nonlinear characteristic, as for any feed-back oscillator system. It is the onset of saturation by the laser radiation itself which tends to equalize the populations in the upper and lower lasing levels.

### NONLINEAR OPTICS

With the development of various types of lasers, the stage was set for a rapid evolution of the study of nonlinear optical phenomena. The demonstration by Franken and coworkers of second harmonic generation of light by a ruby laser pulse in a quartz crystal marks the origin of nonlinear optics as a new separate subfield of scientific endeavor (19). The straightforward experimental arrangement of this demonstration is shown in Fig. 3.

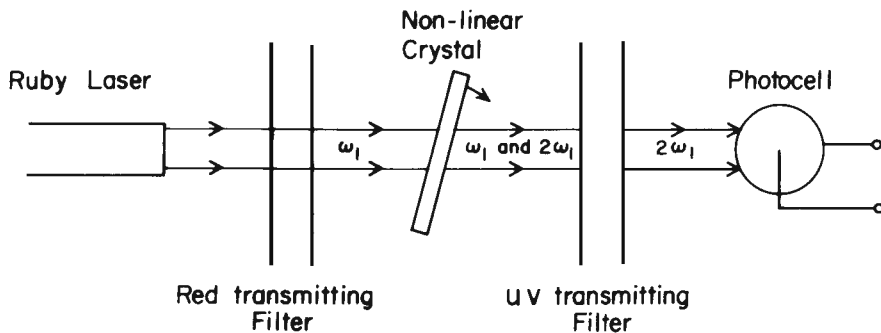

Fig. 3. Second harmonic generation of light



of two fundamental quanta to one quantum at the second harmonic frequency presents itself. Due to color dispersion, one usually has  $\mathbf{k}_2 - 2\mathbf{k}_1 = \Delta\mathbf{k} \neq 0$ . The mismatch in phase velocities between the second harmonic polarization and the freely propagating wave at  $2\omega$  leads to the existence of two waves at  $2\omega$  in the nonlinear crystal, a forced one with wave vector  $\mathbf{k}_s = 2\mathbf{k}_1$  and another with wave vector  $\mathbf{k}_T = \mathbf{k}_2$ , for a freely propagating wave at  $2\omega$ . In addition, there is a reflected second harmonic wave with wave vector  $\mathbf{k}_R$ . Figure 4 depicts the geometry for the case that the nonlinear crystal is embedded in a liquid with a higher linear index of refraction. Conservation of the components of momentum parallel to the surface determines the geometry (24). The amplitudes of the free waves, which are solutions of the homogeneous wave equations, are determined by the condition that the tangential components of the second harmonic electric and magnetic field at the boundary are continuous. Thus a very simple procedure, based on conservation of the component of momentum parallel to the boundary, yields the generalizations of the familiar optical laws of reflection and refraction to the nonlinear case (24). Table 1 illustrates the enormous compression in the time scale of the development of linear and nonlinear geometrical optics. This compression is made possible, of course, by the establishment of a general formulation of electromagnetic phenomena by Maxwell in the second half of the nineteenth century. Lorentz showed in his Ph.D. thesis (25) how the laws of linear reflection, recorded by Hero of Alexandria (first century A.D.), Snell's laws (1621) and Fresnel's laws (1823) for the intensities and polarizations all followed from Maxwell's equations.

It is also suggested by the geometry of Fig. 4 that, on increasing the angle of incidence  $\theta_i$ , nonlinear analogues for total reflection and evanescent surface waves should occur. Indeed, all such predictions have been verified (26), and in

Table 1. Historical dates of linear and nonlinear optical laws

	<i>Linear</i>	<i>Nonlinear</i>
Law of Reflection	1st century (Hero of Alexandria)	1962 (Bloembergen and Pershan)
Law of Refraction	1621 (Snell)	1962 (Bloembergen and Pershan)
Intensity of Reflected and Refracted Light	1823 (Fresnel)	1962 (Bloembergen and Pershan)
Conical Refraction Theory	1833 (Hamilton)	1969 (Bloembergen and Shih)
Experiment	1833 (Lloyd)	1977 (Schell and Bloembergen)

particular the nonlinear coupling between surface excitations is of active current interest (27). In 1833 Hamilton, who was to formulate Hamiltonian mechanics three years later, predicted the phenomenon of conical refraction based on Fresnel's equations of light propagation in biaxial optical crystals. The experimental confirmation in the same year by Lloyd was considered a triumph of the Fresnel equations for the elastic nature of optical propagation! The time lag between the prediction of nonlinear conical refraction and its experimental confirmation was much longer (28), as shown in Table I. In the twentieth century the description of electromagnetic propagation is not in doubt, and most researchers were too busy with more important applications of laser beams than the rather academic problem of nonlinear conical refraction.

The parametric coupling of light waves in a nonabsorbing medium may be considered as the scattering of photons between eigenmodes or waves of the electric field by the material nonlinearity. Heisenberg (29) and others had discussed an intrinsic nonlinearity of the vacuum.

The virtual intermediate states in that process are the electron-hole pair creation states which lie about a million times higher in energy than the excited states of electrons bound in a material medium. Since the energy mismatch of the intermediate states enters as the cube in the expression of  $\chi^{(3)}$ , the vacuum nonlinearity has not been detected. It would be difficult to exclude the nonlinear action of one atom or molecule in the focal volume of extremely intense laser beams used in attempts to detect the nonlinearity of vacuum.

In parametric, nondissipative processes the energy and momentum between incident and emerging photons must be conserved,  $\sum_i \hbar\omega_i = 0$  and  $\sum_i \hbar\mathbf{k}_i = 0$ , where the frequencies and wave vectors of the incident photons are taken to be negative. As noted above, color dispersion generally gives rise to a momentum mismatch  $\Delta\mathbf{k} = \mathbf{k}_2 - 2\mathbf{k}_1$ . This limits the active volume of emission to a layer of thickness  $|\Delta\mathbf{k}|^{-1}$ . It is possible, however, to compensate the color dispersion by optical birefringence in anisotropic crystals. This was demonstrated independently by Giordmaine (30) and by Terhune (31). For  $\Delta\mathbf{k} = 0$ , the polarization in all unit cells in the crystal contributes in phase to the second harmonic field, and if the crystal is long enough and the light intensity high enough, the fundamental power may be quantitatively converted to second harmonic power (21). Phase coherence is essential. For random phases the final state would be one of equipartition with equal power in the fundamental and the second harmonic mode. More than eighty percent of the fundamental power at 1.06  $\mu\text{m}$  wavelength in a large pulsed Nd-glass laser system has recently been converted to third harmonic power (32) at 0.35  $\mu\text{m}$ . In the first step two-thirds of the fundamental power is converted to second harmonic power. Then equal numbers of fundamental and second harmonic photons are combined to third harmonic photons in another crystal. This conversion may be important for the inertial confinement of fusion targets, as the laser-plasma coupling is improved at higher frequencies. The Manley-Rowe relations, which describe the balance in the photon fluxes of the beams participating in a parametric process, are here put to practical use. A few simple conservation laws thus determine many fundamental features of nonlinear optics.



## NONLINEAR SPECTROSCOPY

Processes which are described by the imaginary part of the nonlinear susceptibility,  $\chi^{(3)''}$ , include saturation and cross saturation, twophoton absorption and stimulated Raman effect. The corresponding real part  $\chi^{(3)'}$  describes the intensity dependent index of refraction. It plays a role in self-focusing and defocusing of light, and in creating dynamic optical Stark shifts.

Saturation dip spectroscopy is used extensively to eliminate the effects of Doppler broadening in high resolution spectroscopy and in frequency stabilization of lasers. Consider the case of two traveling waves incident on a gas sample with the same frequency  $\omega$ , but with opposite wave vectors,  $\mathbf{k} = -\mathbf{k}'$ . The wave with  $\mathbf{k}$  produces a saturation dip in the Doppler profile for the velocity packet of molecules satisfying the relation  $\omega = \omega_{\mathbf{ba}} - \mathbf{k} \cdot \mathbf{v}$ , where  $\omega_{\mathbf{ba}}$  is the atomic resonance frequency. The beam in the opposite direction probes the packet satisfying  $\omega = \omega_{\mathbf{ba}} - \mathbf{k}' \cdot \mathbf{v}' = \omega_{\mathbf{ba}} + \mathbf{k} \cdot \mathbf{v}'$ . The two packets coincide only for  $\omega = \omega_{\mathbf{ba}}$ . If  $\omega$  is scanned across the Doppler profile, the probe beam will register a saturation dip exactly at the center. The correspondence with the NMR situation described earlier is clear. At optical frequencies the effect was first demonstrated as a dip in the output of a helium neon laser (33, 34), and is known as the Lamb dip (35). It is experimentally advantageous to observe the effect in an external absorption cell with a strong pump beam in one direction and a weak probe beam in the opposite direction. While the Doppler width of

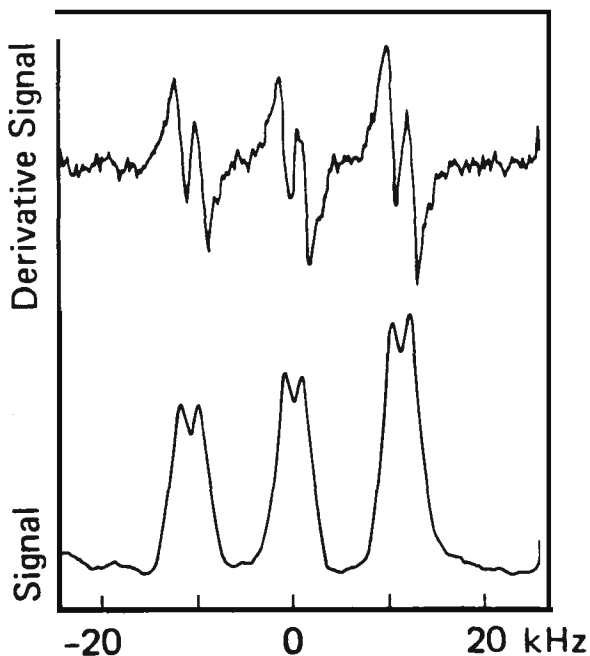

Fig. 5. High resolution ( $< 1$  kHz) saturation spectroscopy of a  $^{12}\text{C}$   $\text{H}_\alpha$  spectral line near  $3.39 \mu\text{m}$  wavelength. Each of the three hyperfine components is split into a doublet from the optical recoil effect. The upper curve is the experimental derivative trace (after reference 36).

the vibrational rotational transition of methane near 3.39  $\mu\text{m}$  wavelength is about 300 MHz, spectral features of about 1 kHz have been resolved by Hall and Borde (36). Figure 5 shows the features of the saturation dip, as the frequency of the probe beam was modulated. Saturation spectroscopy reveals not only a hyperfine structure of the molecular transition due to spin-rotational interaction, but also the infrared photon recoil effect which doubles each individual component. With a resolution approaching one part in  $10^{11}$  many

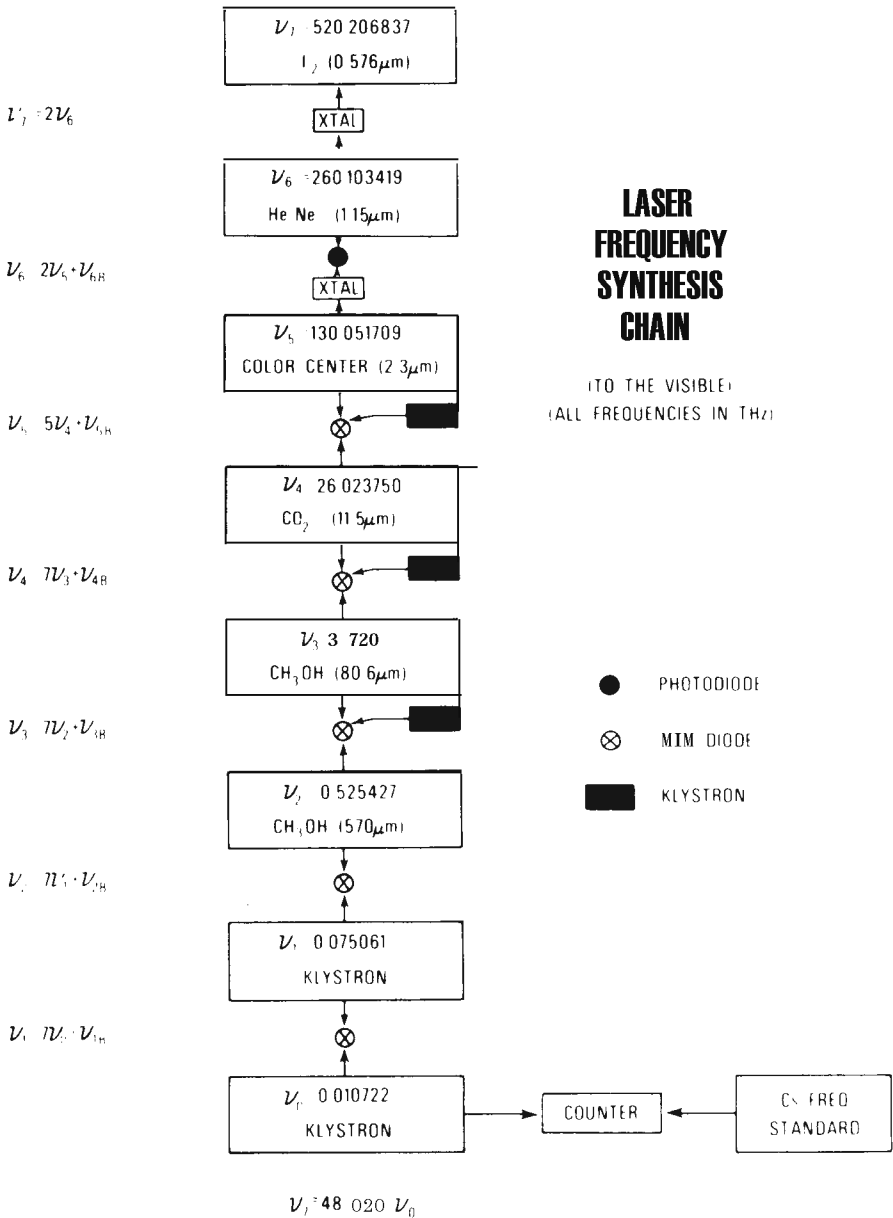

Fig.6. Laser frequency synthesis chain (after reference 38)

other effects, such as curvature of the optical phase fronts and dwell time of the molecules in the beam, must be considered.

The frequencies of lasers throughout the infrared, each stabilized on the saturation dip of an appropriate molecular resonance line, have been compared with each other by utilizing the nonlinear characteristics of tungsten whisker-nickel oxide-nickel point-contact rectifiers (37, 38). The difference frequency between one laser and a harmonic of another laser is compared with a microwave frequency, which in turn is calibrated against the international frequency standard. Thus it has been possible to extend absolute frequency calibrations to the visible part of the spectrum (38), as shown by the chain in Fig. 6. Since the wavelength of the laser is independently compared with the krypton source length standard, it is possible to determine the velocity of light (39) with a precision set by the length standard definition,  $c = 299\,792\,458.98 \pm 0.2$  m/s. It is proposed to define the velocity of light by international agreement, with length measurements then being tied directly to the frequency standard.

The application of saturation spectroscopy to a determination of the Rydberg constant and many other spectroscopic advances are discussed by Schawlow (40). Further details may be found in several comprehensive books on the subject (41-43). Optical saturation spectroscopy has also been carried out in solids, for example for  $\text{Nd}^{3+}$  ions in a crystal of  $\text{LaF}_3$ . Here the analogy with NMR techniques is more striking (44).

Two-photon absorption spectroscopy at optical frequencies, predicted by Goeppert-Mayer (45) was first demonstrated by Kaiser and Garrett (46) for  $\text{E } u^{2+}$  ions in  $\text{CaF}_2$ . When the two photons have different wave vectors, an excitation with energy  $2\hbar\omega$  and wave vector  $\mathbf{k}(\omega) + \mathbf{k}'(\omega)$  may be probed. Fröhlich (47) applied wave vector-dependent spectroscopy by varying the angle between  $\mathbf{k}$  and  $\mathbf{k}'$  to the longitudinal and transverse excitation branches in  $\text{CuCl}$ .

It was suggested by Chebotayev (48) that Doppler-free two-photon absorption features may be obtained in a gas. Consider again two counter-propagating beams. Tune the frequency  $\omega$  so that  $2\omega = \omega_{\text{ba}}$  corresponds to the separation of two levels with the same parity. For processes in which one photon is taken out of the beam with wave vector  $\mathbf{k}$  and the other photon is taken out of the beam with wave vector  $\mathbf{k}' = -\mathbf{k}$ , all atoms regardless of their velocity are resonant. The apparent frequencies  $\omega + \mathbf{k} \cdot \mathbf{v}$  and  $\omega - \mathbf{k} \cdot \mathbf{v}$  of the photons in the two beams in the rest frame of an atom always add up to  $\omega_{\text{ba}}$ . The two-photon absorption signal thus exhibits a very sharp Doppler-free feature, which was demonstrated experimentally in three independent laboratories (49-51). Thus high energy levels, including Rydberg states, of the same parity as the ground state may be studied in high resolution (52). The reader is again referred to the literature for further details (41, 43).

There is, of course, a close correspondence between two-photon absorption and Raman processes. A medium with a normal population difference between two levels  $|a\rangle$  and  $|b\rangle$ , which permit a Raman active transition, will exhibit a gain at the Stokes frequency,  $\omega_s = \omega_L - \omega_{\text{ba}}$ , in the presence of a strong pump

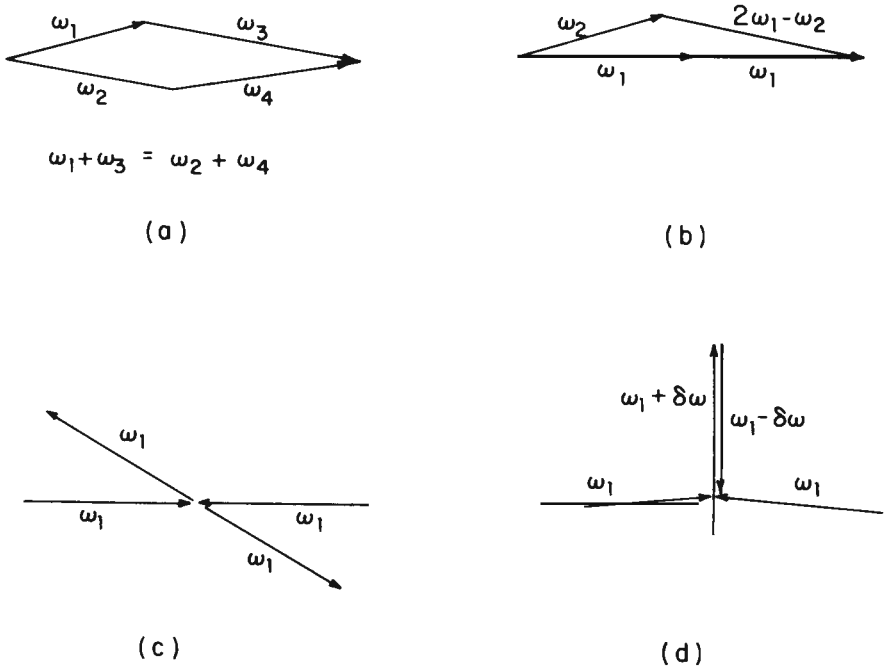

Fig. 7. Some typical wave vector geometries of four-wave light mixing

beam at  $\omega_L$ . Owyong (53), for example, has resolved the line structure in the Q-branch of a vibrational-rotational band of the methane molecule by the technique of stimulated Raman scattering. It is also possible to compare directly the Raman gain and a two-photon absorption loss with these nonlinear techniques.

#### FOUR-WAVE MIXING SPECTROSCOPY

The nonlinearity  $\chi^{(3)}$  describes a coupling between four light waves, and some typical wave vector geometries which satisfy both energy and momentum conservation of the electromagnetic fields are shown in Fig. 7. The generation of a new beam at the frequency  $2\omega_1 - \omega_2$ , due to one incident beam at  $\omega_1$  and another at  $\omega_2$ , corresponding to the geometry in Fig. 7b, was first demonstrated by Maker and Terhune (54, 55). They detected coherent antistokes raman scattering in organic liquids, where the nonlinear coupling constant  $\chi^{(3)}$  exhibits a Raman-type resonance at the intermediate frequency  $\omega_1 - \omega_2$ , as shown schematically in Fig. 8b. Enhancement can also occur by a resonance at the intermediate frequency  $2\omega_1$ . It is thus possible, using light beams at visible wavelengths in a transparent crystal, to obtain information about resonance and dispersive properties of material excitations in the infrared (56, 57) and the ultraviolet (58). An example of this type of nonlinear spectroscopy is shown in Fig. 9. The two-dimensional dispersion of  $\chi^{(3)}(-2\omega_1 + \omega_2, \omega_1, \omega_1, -\omega_2)$  in

CuCl is measured as  $2\omega_1$ , is varied in the vicinity of the sharp  $Z_3$  exciton resonance, while at the same time  $\omega_1 - \omega_2$  is varied in the vicinity of the infrared polariton resonance. The interference of two complex resonances with each other, as well as the interference of their real parts with the nonresonant background contribution to  $\chi^{(3)}$ , leads to a direct comparison of these nonlinearities.

Wave vector-dependent four-wave mixing spectroscopy by variation of the angle between the incident beams was first performed by De Martini (59). The case of enhancement of the CARS process by one-photon absorptive resonances was investigated by several groups (60-62). Figure 8d shows an example of this situation. The CARS technique is used to monitor the composition and temperature profile in flames. In this and other situations with a large incandescent or fluorescent background, the coherent technique provides additional discrimination (63).

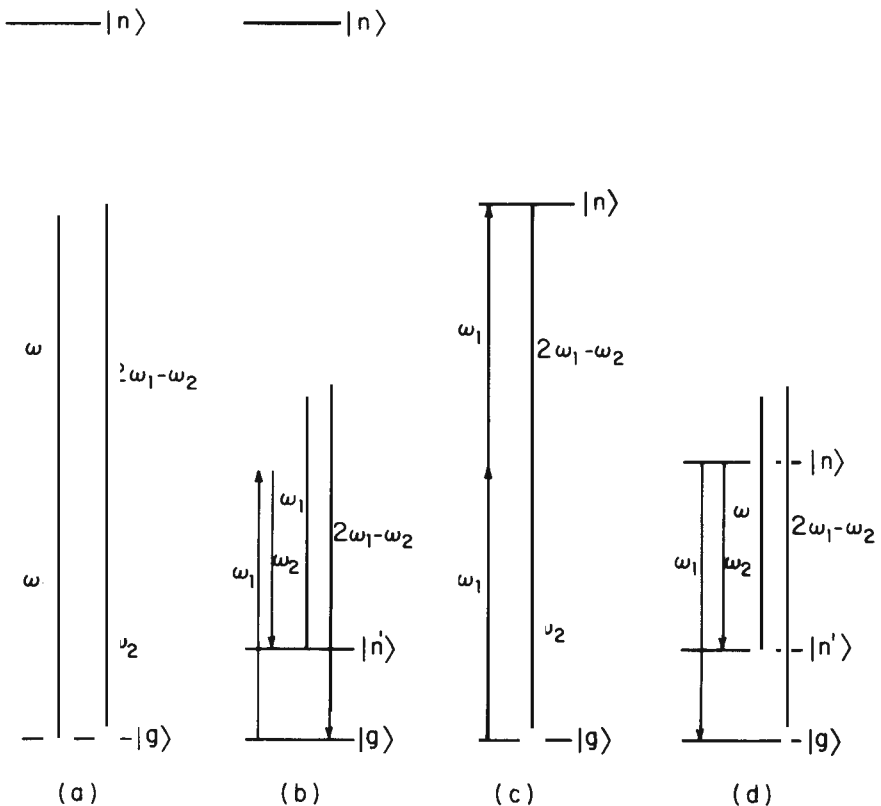

Fig. 8. The creation of a new beam at  $2\omega_1 - \omega_2$  by two incident beams at  $\omega_1$  and  $\omega_2$ , respectively, according to the geometry of Fig. 7b.

- Nonresonant mixing
- Intermediate Raman resonance (coherent antistokes Raman scattering, or CARS)
- Intermediate two-photon absorption resonance
- One-photon resonantly enhanced CARS

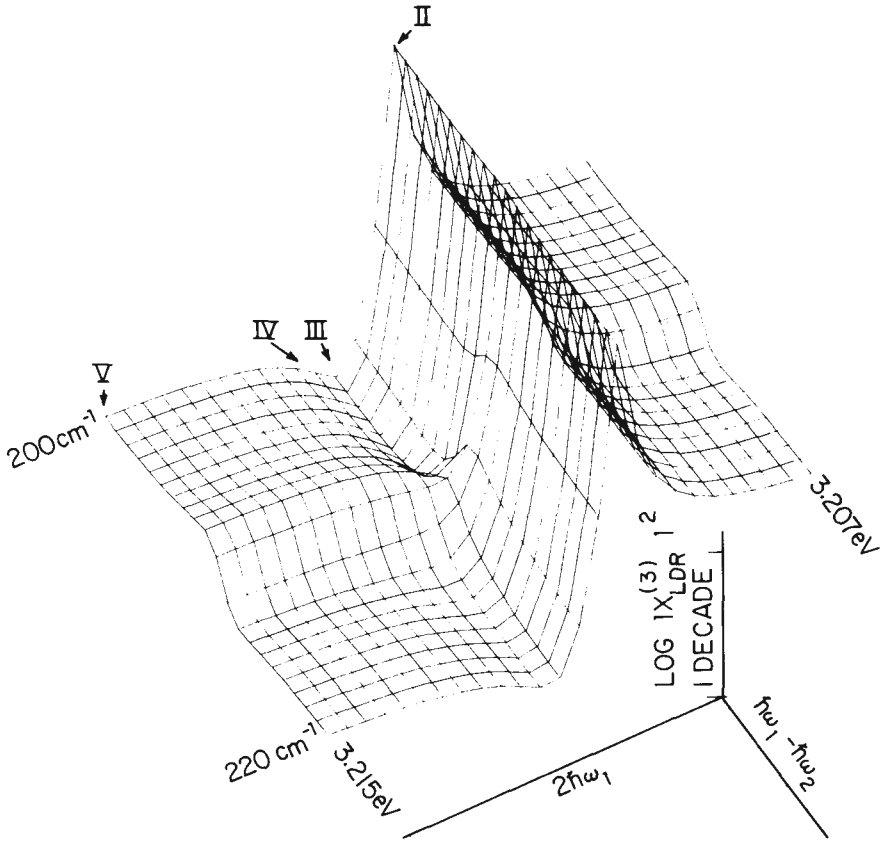

Fig. 9. Two-dimensional frequency dispersion of the nonlinear susceptibility  $\chi^3$  in cuprous chloride (after reference 58).

An important recent application of four-wave mixing is phase conjugation (64). Time-reversed phase fronts are obtained by the frequency-degenerate scattering geometry depicted in Fig. 7c. A strong standing wave pump field provides two beams at  $\omega$  with equal and opposite wave vectors,  $\mathbf{k}_1 = -\mathbf{k}_3$ . The nonlinear medium may be liquid  $\text{CS}_2$ , Na vapor, InSb, an absorbing fluid, a molecular gas, or any other medium (65). A signal beam at the same frequency  $\omega$  has a wave vector  $\mathbf{k}_2$ , which makes an arbitrary small angle with  $\mathbf{k}_1$ . In the four-wave scattering process a new beam with wave vector  $\mathbf{k}_4 = -\mathbf{k}_2$  is created by the nonlinear polarization

$$P_4(\omega) = \chi^{(3)}(-\omega, \omega, \omega, -\omega)E_1E_2^*E_3e^{-i\mathbf{k}_4 \cdot \mathbf{r}}$$

Note that not only the wave vector but also the phase is reversed, because  $E_2^* = |E_2| e^{-i\phi_2}$ . This implies that the backward wave is the time reverse of the signal wave. If the phase front of the latter has undergone distortions in propagation through a medium, these will all be compensated as the backward wave returns through the same medium. The amplitude of the backward wave may show gain, because the parametric process involved takes one photon each

out of the two pump beams and adds one each to the signal and its phase-conjugate beam. The process may also be viewed as real-time instant holography (66). The signal wave forms an intensity interference pattern with each of the pump beams. The physical cause for the grating may be a variation in temperature, in carrier density, in bound space charges, in molecular orientation, depending on the material medium. The other pump reads out this hologram and is scattered as the phase-conjugate wave.

Another variation of nearly degenerate frequency four-wave light mixing has resulted in the recent demonstration of collision-induced coherence (67). Two beams at frequency  $\omega_1$  were incident in a vertical plane on a cell containing Na vapor and helium buffer gas. A third beam at a variable frequency  $\omega_2$  is incident in the horizontal plane. The generation of a beam in a new direction in the horizontal plane is observed at frequency  $2\omega_1 - \omega_2$ . The intensity of this new beam displays resonances for  $\omega_1 = \omega_2$  and  $\omega_1 - \omega_2 = 17 \text{ cm}^{-1}$ , corresponding to the fine structure splitting of the 3P doublet of the Na atom. These resonances, however, occur only in the presence of collisions. Their intensity varies linearly or quadratically with the partial pressure of helium (68). The paradox that a phase-destroying collisional process can give rise to the generation of a coherent light beam is resolved as follows. In four-wave mixing many different scattering diagrams contribute to the final result (60, 61). These different coherent pathways happen to interfere destructively in the wave mixing case under consideration. Collisions of the Na atoms destroy this destructive interference.

## HIGHER ORDER NONLINEARITIES

Higher order terms in the perturbation expansion of equation (1) are responsible for the generation of higher harmonics and multiphoton excitation processes. Akhmanov (69) has studied the generation of fourth harmonics in a crystal of lithium formate and the fifth harmonic in calcite. Reintjes et al. (70) have generated coherent radiation in the vacuum ultraviolet at 53.2 nm and 38.02 nm, as the fifth and seventh harmonic of a laser pulse at 266 nm which was focused into helium gas. The intensity at 266.1 nm was itself derived by two consecutive frequency doublings from a  $\text{Nd}^{3+}$  glass laser at 1.06  $\mu\text{m}$ . Radiation at this infrared wavelength can induce photoelectric emission from tungsten. The energy of four photons is necessary to overcome the work function. This photoelectric current is proportional to the fourth power of the laser intensity (71).

Studies of multiphoton ionization of atoms and molecules has been pioneered by Prokhorov and coworkers (72). There is clear evidence for ionization of xenon by eleven photons at 1.06  $\mu\text{m}$ . The ion current increases as the eleventh power of the intensity (73). The required laser intensities are so high that extreme care must be taken to avoid avalanche ionization started by electrons created from more readily ionizable impurities.

Atoms and molecules may, of course, also be ionized stepwise. A real excited bound state may be reached, whence further excitation beyond the ionization

limit proceeds. The spectroscopy of auto-ionizing states has also been furthered by multiphoton laser excitation (74).

The intermediate resonances in the stepwise ionization process are species selective. The ionization of single atoms may be detected with a Geiger-Müller counter. Resonance ionization spectroscopy (75) uses this device in combination with one or more tunable dye lasers. The presence of a single atom amidst  $10^{20}$  atoms of other species may be detected. Thus rare stable or unstable daughter atoms may be identified in coincidence with the decay of the parent atom. Ultralow level counting may also aid in measuring inverse  $\beta$ -decay products induced by the solar neutrino flux (75).

Many polyatomic molecules with absorption features near the infrared emission lines from pulsed  $\text{CO}_2$  lasers can be dissociated without collisions in a true unimolecular reaction (76,77). In many cases more than thirty infrared quanta at  $\lambda = 9.6$  or  $10.6 \mu\text{m}$  wavelength are needed to reach the dissociation limit. Nevertheless the rate determining the step appears to be a succession of one-photon absorption (and emission) processes (78). The dissociation yield depends on the total energy fluence in the pulse and is largely independent of pulse duration (or peak intensity). This may be understood in terms of the large density of states in polyatomic molecules with a high degree of vibrational excitation. The energy absorbed by one mode is rapidly shared (equipartitioned) with the other degrees of freedom. Intramolecular relaxation times in highly excited polyatomic molecules are often quite short, on the order of one picosecond ( $10^{-12}$  sec). Infrared photochemistry of molecules in highly excited states has been stimulated by the availability of high power lasers. Both multiphoton dissociation and ionization processes can be applied to laser isotope separation (77).

## OPTICAL TRANSIENTS

The perturbation expansion in equation (1) converges only if the Rabi frequency,  $\hbar^{-1} |\langle \text{ex} | \mathbf{b}_a | \text{E} \rangle|$ , proportional the magnitude of the electric dipole matrix element and the field amplitude, is small compared to the detuning from resonance  $\omega - \omega_{\text{ba}}$ , or small compared to the homogeneous width or damping constant  $\Gamma_{\text{ba}}$  of the resonance. When this condition is not satisfied, very interesting nonlinear optical phenomena occur. They again have their precursors in magnetic resonance and include, among others, free induction decay (79), optical nutation (79), optical echoes (80, 81) and split field resonances (82). The one-to-one correspondence of the evolution of any two-level system with the motion of a spin 1/2 system in magnetic resonance offers a convenient basis for description and also has heuristic value (83, 84).

Self-induced transparency (85) describes the propagation of a solitary optical wave or "soliton" which develops when an intense light pulse enters a material medium at a sharp absorbing resonance. The front part of the pulse excites the resonant transition; then the excited resonant state feeds back the energy to the trailing part of the pulse. The net result is that each two-level member of the ensemble executes a complete revolution around the effective field in the



rotating frame of reference (83). In this  $2\pi$  pulse no electromagnetic energy is dissipated in the medium, but the propagation velocity of the energy is slowed down. The fraction of energy stored in the medium does not contribute to the propagation.

The spontaneous emission process in the presence of a large coherent driving field (86, 87), the cooperative radiation phenomena associated with the super-radiant state (88), and the statistical properties (89, 90) of electromagnetic fields with phase correlations have increased our understanding of the concept of the photon.

Short optical pulses have been used extensively for time-resolved studies of transient phenomena and the measurement of short relaxation times. Very powerful pulses of about 10 picosecond ( $10^{-11}$  sec) duration are readily obtained by the technique of mode locking. Generally, the medium is excited by the first short pulse and probed by a second pulse with a variable time delay. The first pulse, for example, may excite a molecular vibration by stimulated Raman scattering. This coherent vibration will interact with the second pulse to give an antistokes component. A picosecond pulse traversing a cell of water generates a nearly continuous white spectrum due to phase modulation. This white picosecond pulse may be used to probe variations in absorption due to the first pulse. These techniques have been developed in depth by Kaiser (91) and others (92). More recently, the creation of light pulses as short as  $4 \times 10^{-14}$  sec has been achieved.

It is also possible, with a picosecond pulse, to melt a thin surface layer of a metal, alloy or semiconductor. After the light pulse is gone, this layer (10-20 nm thick) resolidifies rapidly by thermal conduction to the cool interior. Cooling rates of  $10^{15}$ °C/sec are attainable. Thus it is possible to freeze in amorphous phases or other normally unstable configurations (93). New regimes of solid state kinetics are thus opened up for investigation.

## CONCLUSION

Nonlinear optics has developed into a significant subfield of physics. It was opened up by the advent of lasers with high peak powers. The availability of tunable dye lasers has made detailed nonlinear spectroscopic studies possible throughout the visible region of the spectrum, from 0.35 to 0.9  $\mu$ m. Conversely, nonlinear techniques have extended the range of tunable coherent radiation. Harmonic generation, parametric down conversion, and stimulated Raman scattering in different orders have all extended the range from the vacuum ultraviolet (94) to the far infrared (95). The soft X-ray region still presents a challenge.

Nonlinear optical processes are essential in many applications. Modulators and demodulators are used in optical communications systems. Saturable absorption and gain play an essential role in obtaining ultrashort pulses. The domain of time-resolved measurement may be extended to the femtosecond domain. This opens up new possibilities in materials science and chemical kinetics. A detailed understanding of nonlinear processes is essential in pushing

the frontiers of time and length metrology, with applications to geological and cosmological questions.

The field of nonlinear spectroscopy has matured rapidly but still has much potential for further exploration and exploitation. The applications in chemistry, biology, medicine, materials technology, and especially in the field of communications and information processing are numerous. Alfred Nobel would have enjoyed this interaction of physics and technology.

I wish to express my indebtedness to my coworkers and graduate students, past and present, as well as to many colleagues, scattered in institutions around the globe, whose work in nonlinear optics and spectroscopy, cited or uncited, is also honored by this award.

## REFERENCES

1. Townes, C. H., in *Nobel Lectures in Physics* (Elsevier, Amsterdam, 1972). Vol. 4. p. 58.
2. Basov, N. G., *ibid.*, p. 89.
3. Prokhorov, A. M., *ibid.*, p. 110.
4. Salinger, H., *Archiv. f. Elektrotechnik* 12, 268 (1923).
5. Lorentz, H. A., *Theory of Electrons* (Teubner, Leipzig, 1909).
6. Bloembergen, N., Purcell, E. M. and Pound, R. V., *Phys. Rev.* 73, 679 (1948).
7. Pound, R. V., *Phys. Rev.* 79, 685 (1950).
8. Kastler, A., in *Nobel Lectures in Physics* (Elsevier, Amsterdam, 1972). Vol. 4, p. 186.
9. Overhauser, A. W., *Phys. Rev.* 91, 476 (1953).
10. Carver, T. R. and Slichter, C. P., *Phys. Rev.* 102, 975 (1956).
11. See, for example, Abragam, A., *Principles of Nuclear Magnetism* (Oxford University Press, London, 1960).  
Goldman, M., *Spin Temperature and Nuclear Magnetic Resonance in Solids* (Oxford University Press, London, 1970).
12. Bloembergen, N., *Phys. Rev.* 104, 324 (1956).
13. Basov, N. G. and Prokhorov, A. M., *Zh. Eksp. Teor. Fiz.* 28, 249 (1955).
14. Scovil, H. E. D. and Schulz-du Bois, E. O., *Phys. Rev. Lett.* 2, (1955).
15. Bloembergen, N., Shapiro, S., Pershan, P. S. and Artman, J. O., *Phys. Rev.* 114, 445 (1959).
16. Wilson, R. W., "Nobel Lecture 1978," in *Rev. Mod. Phys.* 51, 767 (1979).
17. Schawlow, A. I., and Townes, C. H., *Phys. Rev.* 112, 1940 (1958).
18. Maiman, T. H., *Nature* 187, 493 (1960).
19. Franken, P., Hill, A. E., Peters, C. W. and Weinreich, G., *Phys. Rev. Lett.* 7, 118 (1961).
20. Forrester, A. T., Gudmundsen, R. A. and Johnson, P. O., *Phys. Rev.* 99, 1961 (1955).
21. Armstrong, J. A. Bloembergen, N., Ducuing, J. and Pershmn, P. S., *Phys. Rev.* 128, 606 (1962).
22. Bloembergen, N. and Shen, Y. R., *Phys. Rev.* 133, A 37 (1963).
23. Akhmanov, C. A. and Khokhlov, R. V., *Problems in Nonlinear Optics* (Academy of Sciences, USSR, Moscow, 1964).
24. Bloembergen, N. and Pershan, P. S., *Phys. Rev.* 128, 606 (1962).
25. Lorentz, H. A., *Collected Papers* (Martinus Nyhoff, The Hague, 1935). Vol. I.
26. Bloembergen, N., Simon, H.J. and Lee, C. H., *Phys. Rev.* 181, 1261 (1969).
27. DeMartini, F., Colocci, M., Kohn, S. E. and Shen, Y. R., *Phys. Rev. Lett.* 38, 1223 (1977).
28. Schell, A. J, and Bloembergen, N., *Phys. Rev.* A18 2592 (1978).
29. Hcisenberg, W and Euler, H., Z., *Phys.* 98, 714 (1936).
30. Giordmaine, J.A, *Phys. Rev. Lett.* 8, 19 (1962).
31. Maker, P. D., Terhune, R. W., Nisenhoff, M and Savage, C. M., *Phys. Rev. Lett.* 8, 21 (1962).

32. Seka, W., Jacobs, S. D., Rizzo, J. E., Boni, R. and Craxton, R. S., *Opt. Commun.* 34, 469 (1980).
33. Szoke, A. and Javan, A., *Phys. Rev. Lett.* 10, 521 (1963).
34. McFarlane, R. A., Bennett, W. R. Jr. and Lamb, W. E. Jr., *Appl. Phys. Lett.* 2, 189 (1963).
35. Lamb, W. E., *Phys. Rev.* 134, 1429 (1964).
36. Hall, J. L., Bordé, C. J. and Uehara, K., *Phys. Rev. Lett.* 37, 1339 (1976).
37. Hocker, L. O., Javan, A. and Ramachandra Rao, D., *Appl. Phys. Lett.* 10, 147 (1967).
38. Jenning, D. A., Petersen, F. R. and Evenson, K. M., in *Laser Spectroscopy IV*, edited by H. Walther and K. W. Rothe (Springer, Heidelberg, 1979), p. 39.
39. Baird, K. M., Smith, D. S. and Whitford, B. C., *Opt. Commun.* 31, 367 (1979); Rowley, W. R. C., Shotton, K. C. and Woods, P. T., *ibid.* 34, 429 (1980).
40. Schlawlow, A. L., *Les Prix Nobel 1981* (Almqvist and Wiksell International, Stockholm, 1982); also *Rev. Mod. Phys.*, to be published (1982).
41. *High-Resolution Laser Spectroscopy*, edited by K. Shimoda, *Topics in Applied Physics* 13 (Springer-Verlag, Berlin, Heidelberg, 1976).
42. Letokhov, V. S. and Chebotayev, V. P., *Nonlinear Laser Spectroscopy*, Springer Series in Optical Sciences 4 (Springer-Verlag, Berlin, 1977).
43. Levenson, M. D., *Introduction to Nonlinear Laser Spectroscopy* (Academic Press, New York, 1982).  
The author is indebted to Dr. M. D. Levenson for having received a preprint of his manuscript
44. McFarlane, R. M. and Shelby, R. M., *Opt. Lett.* 6, 96 (1981).
45. Goepfert-Meyer, M., *Ann. Phys.* 9, 273 (1931).
46. Kaiser, W. and Garrett, G. C. B., *Phys. Rev. Lett.* 7, 229 (1961).
47. Fröhlich, D., Staginnus, B. and Schönherr, E., *Phys. Rev. Lett.* 19, 1032 (1967).
48. Vasilinko, L. S., Chebotayev, V. P. and Shishaev, A. V. *JETP Lett.* 12, 113 (1970).
49. Cagnac, B., Grynberg, G. and Biraben, F., *Phys. Rev. Lett.* 32, 643 (1974).
50. Levenson, M. D. and Bloembergen, N., *Phys. Rev. Lett.* 32, 645 (1974).
51. Hänisch, T. W., Harvey, K. C., Meisel, G. and Schawlow, A. L., *Opt. Commun.* 11, 50 (1974).
52. Stoicheff, B. P. and Weinberger, E., in *Laser Spectroscopy IV*, edited by H. Walther and K. W. Rothe (Springer, Heidelberg, 1979), p. 264.
53. Owyong, A., Patterson, C. W. and McDowell, R. S., *Chem. Phys. Lett.* 59, 156 (1978).  
For a historical review of the early work in the stimulated Raman effect, see:  
Bloembergen, N., *Am. J. of Phys.* 35, 989 (1967).
54. Terhune, R. W., *Solid State Design* 4, 38 (1963).
55. Maker, P. D. and Terhune, R. W., *Phys. Rev.* 137, A801 (1965).
56. Levenson, M. D. and Bloembergen, N., *Phys. Rev. B* 10, 4447 (1974).
57. Lotem, H., Lynch, R. T. Jr., and Bloembergen, N., *Phys. Rev. A* 14, 1748 (1976).
58. Kramer, S. D. and Bloembergen, N., *Phys. Rev. B* 14, 4654 (1976).
59. Coffinet, J. P. and DeMartini, F., *Phys. Rev. Lett.* 22, 60 (1969).
60. Bloembergen, N., Lotem, H. and Lynch, R. T. Jr., *Ind. J. of Pure & Appl. Phys.* 16, 151 (1978).
61. Attal, B., Schnepf, O. O., Taran, J.-P. E., *Opt. Commun.* 24, 77 (1978).  
Druet, S. A. J., Taran, J.-P. E. and Bordé, Ch. J., *J. Phys. (Paris)* 40, 819 (1979).
62. Carreira, L. A., Goss, J. P. and Malloy, T. B., Jr., *J. Chem. Phys.* 69, 855 (1978).
63. Eckbreth, A. C., *Appl. Phys. Lett.* 32, 421 (1978).
64. Hellwarth, R. W., *J. Opt. Soc. Am.* 67, 1 (1977).
65. See, for example, a number of papers by various authors published in *Opt. Lett.* 5, 51, 102, 169, 182 and 252 (1980), and other references quoted therein.
66. Gabor, D., *Les Prix Nobel 1971* (P. A. Norstedt & Söner, Stockholm, 1972), p. 169.
67. Prior, Y., Bogdan, A. R., Dagenais, M. and Bloembergen, N., *Phys. Rev. Lett.* 46, 111 (1981).
68. Bloembergen, N., Bogdan, A. R. and Downer, M., in *Laser Spectroscopy V*, edited by A. R. W. McKellian, T. Oka and B. Stoicheff (Springer-Verlag, Heidelberg, 1981), p. 157.
69. Akhmanov, S. A., in *Nonlinear Spectroscopy*, edited by N. Bloembergen, *Fermi Course 64* (North-Holland Publishing Co., Amsterdam, 1977), p. 239.
70. Reintjes, J., Eckardt, R. C., She, C. Y., Karangelen, N. E., Elton, R. C. and Andrews, R. A., *Phys. Rev. Lett.* 37, 1540 (1976); *Appl. Phys. Lett.* 30, 480 (1977).

71. Bechtel, J. H., Smith, W. L. and Bloembergen, N., *Opt. Commun.* 13, 56 (1975).
72. Bunkin, F. V. and Prokhorov, A. M., *Zh. Eksp. Teor. Fiz.* 46, 1090 (1964); Bunkin, F. V., Karapetyan, R. V. and Prokhorov, A. M., *ibid.* 47, 216 (1964).
73. LeCompte, C., Mainfray, G., Manus, C. and Sanchez, F., *Phys. Rev. Lett.* 32, 265 (1972).
74. Armstrong, J. A. and Wynne, J. J., in *Nonlinear Spectroscopy*, edited by N. Bloembergen, E. Fermi, Course 64 (North-Holland Publishing Co., Amsterdam, 1977), p. 152.
75. Hurst, G. S., Payne, M. G., Kramer, S. D. and Young, J. P., *Rev. Mod. Phys.* 51, 767 (1979).
76. Isenor, N. R. and Richardson, M. C., *Appl. Phys. Lett.* 18, 225 (1971).
77. Ambartsumian, R. V., Letokhov, V. S., Ryabov, E. A. and Chekalin, N. V., *JETP Lett.* 20, 273 (1974).
78. Bloembergen, N., *Opt. Commun.* 15, 416 (1975).
79. Brewer, R. G., in *Nonlinear Spectroscopy*, edited by N. Bloembergen, E. Fermi, Course 64 (North-Holland Publishing Co., Amsterdam, 1977), p. 87.
80. Kurnit, N. A., Abella, I. D. and Hartman, S. R., *Phys. Rev. Lett.* 13, 567 (1964); *Phys. Rev.* **141**, 391 (1966).
81. Mossberg, T. W., Whittaker, F., Kachru, R. and Hartmann, S. R., *Phys. Rev. A* 22, 1962 (1980).
82. Salour, M. M. and Cohen-Tannoudji, C., *Phys. Rev. Lett.* 38, 757 (1977).
83. Rabi, I. L., Ramsey, N. F. and Schwinger, J. S., *Rev. Mod. Phys.* 26, 167 (1954).
84. Feynman, R. P., Vernon, F. L. and Hellwarth, R. W., *J. Appl. Phys.* 28,49 (1957).
85. McCall, S. L. and Hahn, E. L., *Phys. Rev. Lett.* 18, 908 (1967); *Phys. Rev.* **183**, 457, (1969).
86. Mollow, B. R., *Phys. Rev.* 188, 1969 (1969).
87. Cohen-Tannoudji, C. and Reynaud, S., *J. Phys. B* 10, 345 (1977).
88. Gibbs, H. M., Vrethen, Q. H. F. and Hikspoors, H. M. J., *Phys. Rev. Lett.* 39, 547 (1977).
89. Glauber, R., *Phys. Rev.* 131, 2766 (1963).
90. See, for example, *Coherence and Quantum Optics IV*, edited by L. Mandel, and E. Wolf, (Plenum Press, New York, 1978).
91. van der Linde, D., Laubereau, A. and Kaiser, W. *Phys. Rev. Lett.* 26, 954 (1971).
92. See, for example, *Ultrashort Light Pulses*, edited by Shapiro, S. L., Topics in Applied Physics 18 (Springer-Verlag, Heidelberg, 1977).
93. Liu, J. M., Yen, R., Kurz, H. and Bloembergen, N., *Appl. Phys. Lett.* 39, 755 (1981).
94. Harris, S. E., *Appl. Phys. Lett.* 31, 398 (1977); Harris, S. E. *et al.*, in *Laser Spectroscopy V*, edited by A. R. W. McKellan, T. Oka, and B. Stoicheff, (Springer-Verlag, Heidelberg, 1981), p. 437.
95. Byer, R. L. and Herbst, R. L., in *Nonlinear Infrared Generation*, edited by Y. R. Shen, Topics in Applied Physics 16 (Springer-Verlag, Heidelberg, 1977), p. 81; V. T. Nguen, and T. J. Bridges, *ibid.*, p. 140; J. J. Wynne, and P. P. Sorokin, *ibid.*, p. 160.